



Skycut Series D with SignCut Pro2

July 3, 2020

You can expect updates to this manual over the next few months

Do NOT read this entire manual... unless you want to.

- At the start of Chapters 1 - 4 are short sections with references to find what you need plus some important reminders. PLEASE read these short sections at the very least and refer back to them, when needed.
- Chapters 1 and 2 are very important in terms of correctly setting up your Skycut to work with SignCut Pro2 and learning the ins and outs of cutting.
- Chapter 3 is for those owners wanting to perform print and cut applications.
- Chapter 4 covers using Skycut accessory tools and dual head applications.
- Chapter 5 covers several SignCut Pro2 functions of interest: creating contour cuts and engraving fills.

It's not practical to print this entire manual because:

- It's a waste of paper and ink if you only ever need certain sections.
- The live links to videos and web sites in the manual will not work.
- This manual will be updated from time to time.
- You cannot search on individual words.

Also:

- Videos of interest can be found at the following link: [Skycut Support Videos](#)



Table of Contents



SKY CUT SERIES D WITH SIGNCUT PRO2	1
1. INTRODUCTION AND SETTING UP	5
1.00 QUICK REFERENCE FOR THIS CHAPTER	5
1.01 SUPPORT	5
1.02 SAFETY AND WARNINGS	5
1.03 WARRANTY	6
1.04 UNPACKING	6
1.05 CONTENTS	6
1.06 PARTS OF THE SKY CUT	7
<i>Front</i>	7
<i>Right Side</i>	8
<i>Left Side</i>	8
<i>Back</i>	8
1.07 ACCESSORIES	9
1.07.1 <i>Tables (optional)</i>	9
1.07.2 <i>Test Pen</i>	10
1.07.3 <i>Skycut Blades</i>	10
1.07.4 <i>Blade Installation</i>	11
1.08 PREPARING AND CARING FOR THE CUTTING MAT	12
1.08.1 <i>Tips on Using the Cutting Mat</i>	12
1.08.2 <i>Cleaning and Replenishing the Cutting Mat</i>	12
1.09 PINCH WHEELS	13
1.10 CONTROL PANEL	14
1.10.1 <i>Set Screen</i>	14
1.11 INTRODUCTION TO SIGNCUT PRO 2	15
1.11.1 <i>Installing SignCut</i>	15
1.11.2 <i>Sign Cut Screens</i>	15
<i>SignCut Pro2:</i>	17
1.12 CONNECTING THE SKY CUT TO YOUR COMPUTER	17
1.12.1 <i>USB Connection</i>	18
1.12.2 <i>Wi-Fi Connection</i>	19
1.12.3 <i>Wireless Stand-Alone</i>	22
1.12.4 <i>USB Flash Drive</i>	24
1.13 TEST DRAW SHAPES	27
1.13.1 <i>Inserting the Paper and Setting the Origin</i>	27
1.13.2 <i>Default Settings in SignCut Pro</i>	29
1.13.3 <i>Adding a Test Shape to Draw</i>	30
1.13.4 <i>Drawing the Shape from SignCut Pro</i>	32
1.14 DEFAULT SETTINGS TO CONSIDER	36
1.14.1 <i>Advanced Settings</i>	36
1.14.2 <i>General Settings</i>	38
1.14.3 <i>Sys Information</i>	40
1.15 MAINTENANCE	41
1.16 OTHER USEFUL TOOLS AND SUPPLIES	41
2. CUTTING	43
2.00 QUICK REFERENCE FOR THIS CHAPTER	43
2.01 WHAT YOU NEED TO UNDERSTAND ABOUT CUTTING	43
2.01.1 <i>You Have To Make Mistakes</i>	43
2.01.2 <i>Record Your Successes</i>	44
2.01.3 <i>Installing the Blade Holder, Test Pen, or Accessory Tools</i>	44
2.01.4 <i>Adjust the Speed, Force, and Number of Passes Based on the Material and Shapes</i>	45

2.01.5 Perform Test Cuts!.....	45
2.01.6 Keep the Cutting Mat Clean and Sticky.....	45
2.01.7 Don't Get Frustrated, Get Help!	45
2.02 CHOICES BEFORE CUTTING	46
2.02.1 Controlling Which Shapes Will Cut.....	46
2.02.2 Controlling Where Shapes Will Cut.....	49
2.02.3 Where to Enter Cut Settings	50
2.03 CUT SETTINGS.....	54
2.03.1 Force.....	54
2.03.2 Cut Speed and Up Speed.....	54
2.03.3 Blade Offset	55
2.03.4 Overcut.....	56
2.03.5 Passes	56
2.03.6 Pounce (Dashed-line Cutting).....	59
2.04 PRESETS	60
2.04.1 Saving a Preset in SignCut Pro	60
2.04.2 Saving a Preset for a Material.....	60
2.05 SETTING THE ORIGIN BEFORE CUTTING	63
2.05.1 Setting an Origin Using the Camera	64
2.06 OTHER CUT SETTING FUNCTIONS	66
2.06.1 Advance Mode	66
2.06.2 Mirror.....	67
2.06.3 Weeding Line Tools	67
2.06.4 Tiling Options	71
2.07 IMPORTANT CHECKLIST BEFORE YOU CUT!	78
2.08 SCALE CALIBRATION.....	79
2.08.1 Skycut Resolution Using Millimeters for Measurement	79
2.08.2 Skycut Resolution Using Inches for Measurement.....	82
2.08.3 Scale Calibration Storage on the Control Panel.....	83
2.09 TEST CUTTING FLOW CHART FOR THE SKYCUT.....	86
2.10 SETTINGS FORM FOR CUTTING MATERIALS	87
2.11 SUGGESTED SETTINGS FOR VARIOUS MATERIALS.....	88
3. PRINT AND CUT (CONTOUR CUT)	90
3.00 QUICK REFERENCE FOR CHAPTER 3	90
3.01 WHAT IS A PRINT AND CUT (PNC)?	90
3.02 WHAT IS A PNC CALIBRATION?.....	91
3.03 CAMERA CALIBRATION PROCEDURE.....	91
3.03.1 What You Need for Calibrating	91
3.03.2 Calibration Process.....	91
3.04 PERFORMING A PNC IN SIGNCUT PRO.....	94
3.04.1 Summary of Steps.....	94
3.04.2 Preparing the Registration Marks	95
3.04.3 Contour Cutting Project – Accuracy Test.....	96
3.05 INACCURATE CUTS.....	99
3.05.1 Adjusting the Calibration Values.....	99
3.05.2 Inaccurate Tracings	100
3.05.3 Incorrect Cut Settings	100
3.06 CONTOUR CUTTING MULTIPLE IMAGES AND ADDING INTERMEDIATE REGISTRATION MARKS	101
3.06.1 Setting Up Multiple Raster Images in Another Program.....	101
3.06.2 Using Intermediate Registration Marks.....	102
3.06.3 Automatically Adding Intermediate Registration Marks in SignCut Draw.....	105
3.07 PNC FROM USB FLASH DRIVE	106
3.07.1 PNC from Flash Drive – Single Cut	106
3.07.2 PNC from Flash Drive – Using Array Mark for Repeats	108
3.07.3 Mark Set Options	110
4. ACCESSORY TOOLS AND DUAL HEAD CALIBRATION	113
4.00 QUICK REFERENCE FOR CHAPTER 4	113
4.01 DUAL HEAD CALIBRATION.....	113
4.02 DRAWING WITH THE TEST PEN.....	117

4.02.1 <i>Draw and Cut</i>	117
4.02 EMBOSSING AND SCORING	119
4.02.1 <i>General Info on Embossing</i>	119
4.02.2 <i>Score and Cut Project</i>	119
4.02.3 <i>Embossing Paper or Cardstock</i>	120
4.03 SCRATCH ENGRAVING	121
4.03.1 <i>Engraving a Metal Tag</i>	121
4.05 SETTINGS FORM FOR ACCESSORY TOOLS.....	126
5. SIGNCUT DRAW FUNCTIONS OF INTEREST	127
5.00 QUICK REFERENCE FOR CHAPTER 5	127
5.01 ADDING A CONTOUR CUT LINE TO A RASTER IMAGE	127
5.01.1 <i>Importing an Image to Trace</i>	127
5.01.2 <i>Step-by-Step Tracing Process</i>	128
5.02 EDITING A TRACE	131
5.02.1 <i>Node Editing a Contour Cut</i>	131
5.02.2 <i>Deleting Paths Within a Contour Cut Trace</i>	132
5.03 ENGRAVING FILLS	133
5.03.1 <i>Hatch Fill</i>	133
5.03.2 <i>Contour Fill</i>	135
5.03.3 <i>Inside Fills Versus Outside Fills</i>	136
5.03.4 <i>Line Raster from Bitmap</i>	136
APPENDIX A TROUBLESHOOTING FAQ'S.....	140
A1 COMMUNICATION ISSUES.....	140
A2 OPERATING ISSUES.....	141
A3 CUTTING/DRAWING ISSUES	143

1. Introduction and Setting Up

1.00 Quick Reference for This Chapter

- How to download and set up SignCut Pro2: *Section 1.11*
- How to set up communication between a computer and Skycut: *Section 1.12*
- How to use the control panel: *Sections 1.10 and 1.14*
- How to adjust the blade holder: *Section 1.07.3*
- Where to position the pinch wheels: *Section 1.09*
- The cutting mat is too sticky (or not sticky enough): *Section 1.08*
- How to use the USB Flash Drive feature: *Section 1.12.4*

Important Notes:

- Please read *Section 1.02* regarding safe operation of the Skycut.
- Report any damage or missing contents to your dealer promptly.
- Retain the original box and packing materials in case you ever need to ship your Skycut.

1.01 Support

- Thank you for choosing a Skycut digital die cutter. Before using a blade in your new cutter, we urge you to read *Chapters 1 and 2* and watch the videos linked in these chapters.
- If you run into difficulties with the operation of your Skycut, turn off the power and look for a solution in this manual. Note that *Appendix A* is a **Troubleshooting** section. If you continue to have technical questions or issues, please contact your dealer as soon as possible.
- If anything is missing from your order or you have mechanical issues with your Skycut, please contact your dealer as soon as possible. You can also contact Skycut directly using this email address: skycut@skycut.cn.
- For additional information and support with the Skycut, please check out the following:
 - ◇ Skycut web site: <http://www.sky-cut.com/>
 - ◇ Skycut Facebook page: <https://www.facebook.com/skycutcuttingplotter/>
 - ◇ Skycut Facebook group: <https://www.facebook.com/groups/Skycut/>
 - ◇ Skycut YouTube channel: <https://www.youtube.com/channel/UCrPn5hFLbiRNDgccY8iXwoA>
 - ◇ SignCut User Guide: available in SignCut Draw (**Help>User Guide**) and in SignCut Pro (**Help>Help**)
- For SignCut support, please go to <https://signcut.freshdesk.com/support/home>

1.02 Safety and Warnings

Please be aware of the following safety guidelines when working with the Skycut:

- **Pinch Points:** Keep hands, long hair, loose clothing, jewelry, etc. away from the moving parts.
- **Risk to Children and Pets:** Please supervise children around the cutter when it is in use.
- **Movement and Touching:** Do not move the Skycut or touch any circuitry while it is plugged in.

- DO NOT touch or jam the plotter's track while it is operating. If the cutter is damaged, it is the owner's responsibility.
- DO NOT shake the cutter while it is operating.
- DO NOT cut any materials that have staples or other embellishments attached.
- DO NOT touch the cutter with a magnet. It is safe, however, to cut magnetic materials, such as those used on refrigerators and car exteriors.
- DO NOT allow any liquids to spill into the cutter.
- DO NOT allow small items to fall into the cutter.
- Place the Skycut on a sturdy and stable table, desk, or trolley. The optional Skycut stand can also be used.
- Always turn off the Skycut when not in use. Leaving the cutter turned on for extended periods of time can possibly damage the machine.
- Always turn off the Skycut before unplugging or removing the power cable from the wall outlet or power strip.
- Unplug the Skycut from a wall outlet or power strip during an electrical storm or when the cutter will not be used for an extended period of time.
- Transporting: When transporting the cutter, move the pinch wheel lever into the upward position. Remove the blade from the blade holder and cover the tip with the plastic cap.

1.03 Warranty







- ***IMPORTANT!*** If your Skycut is damaged during shipment or appears to be defective, your dealer should be notified as soon as possible.
- For additional information regarding your warranty, please refer to your Skycut dealer.
- It is recommended that you **retain the original box with packing materials** in case you ever need to ship your Skycut.

1.04 Unpacking

- Verify that you have received all contents. There is a checklist in *Section 1.05*. Please notify your Skycut supplier immediately if anything is missing.
- Remove all packaging before turning on the Skycut. Currently, the cutter ships with two end cap foam protectors, four plastic zip ties, and tape on either end of the cutting strip. **Be very careful when removing the zip ties - only cut those ties and NOT the black cable behind them.** Gently remove the tape at the ends of the cutting strip by rolling the tape away. Do not pull straight up.
- Because the cutting mat must be folded over to fit into the box, it may have become slightly rounded during shipping. Gently and only partially roll the mat in the opposite direction to remove the roundness and place on a flat table to make sure the mat now lies horizontally to the surface. Refer to *Section 1.08* for additional instructions on preparing the mat for use.
- Use the enclosed test pen as you experiment and become familiar with operating the Skycut. Place scrap paper on the mat and simply draw shapes rather than cut them. This will prevent possible damage to the blade, mat, and cutting strip as you learn where shapes will cut and the basic operating procedures.

1.05 Contents

- Besides the cutter, your box should also contain the following items:

#	Description	Image	Quantity
1	Power cable		1
2	USB Cable		1
3	60° Blade(blue cap)		1
4	45° Blade(red cap)		2
5	Blade Holder		2
6	Test Pen and 1 Refill		2 sets
7	Cutting Mat		1

1.06 Parts of the Skycut

Front

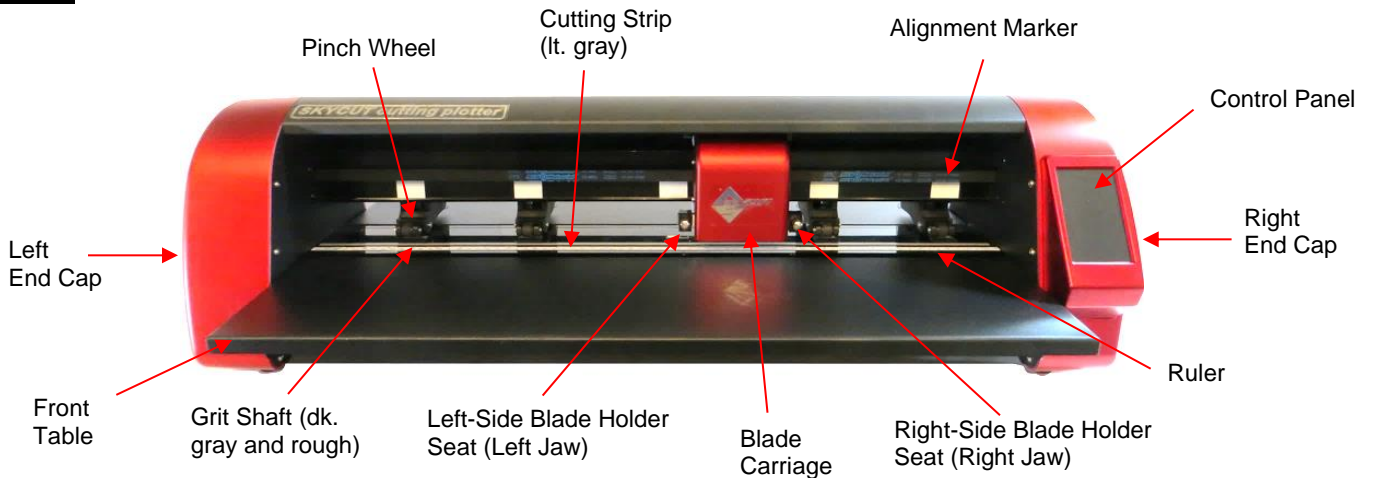

- Alignment Markers: indicate to the user the available positions for the pinch wheels

- Blade Carriage: moves the Blade Holder Seats left and right
- Blade Holder Seats or Jaws (2 on D models): hold the blade holder, test pen, and other accessories
- Control Panel: used to change settings, set up Wi-Fi, calibrate camera, cut PLT files, and more
- Cutting Strip: protects a blade when cutting backed materials without using a cutting mat
- Front Table: keeps cutting mat supported horizontally
- Grit Shafts (5 on 24" model): allow the pinch wheels to grip the mat or material so they can be moved in and out of the cutter during cutting
- Pinch Wheels (4 on 24" model): grip the mat or material so that the grit shafts beneath will feed the mat or material in and out during cutting
- Ruler: for measuring and aligning rolled materials

Right Side

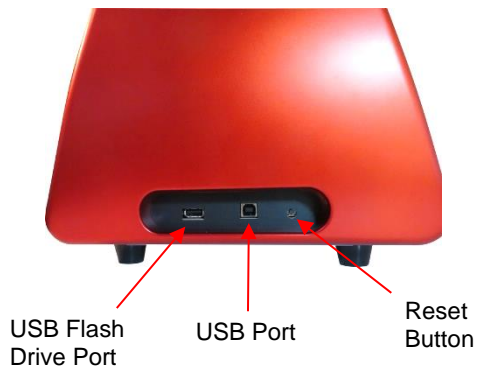

- USB Flash Drive Port: used to load PLT files via control panel for cutting
- USB Port: option to connect computer to Skycut with included USB cable
- Reset Button: used to reset Skycut's cutting buffer (does not reset calibrations)

Left Side



- Power Port: plug power cable into this port
- On/Off Switch: power cutter on or off

Back

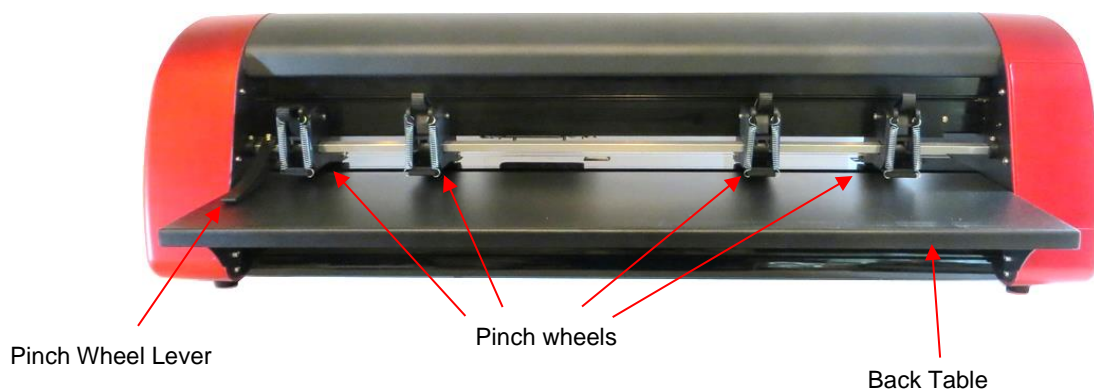

- Pinch Wheels (4 on 24" model): grip the mat or material so that the grit shafts beneath will feed the mat or material in and out during cutting
- Pinch Wheel Lever: raises and lowers the pinch wheels
- Back Table: keeps cutting mat supported horizontally

1.07 Accessories

1.07.1 Tables (optional)

- The following instructions are for the original table design. If the tables you purchase have brackets that are not part of the table, please watch this video: [Video](#)
- While the two tables attach onto the cutter and do not require any support, you may prefer to not use them, especially if you are only cutting rolled materials. However, if you are using the cutting mat, the support they provide will keep the mat horizontal, thus reducing the chance of the mat drooping and causing materials to separate from the adhesive on the mat.
- The screws required for attaching are already installed in the Skycut. They will be removed and then, after aligning the holes in the table, replaced to securely attach the table.
- It's much easier to install if you have a second person available to hold the tables in place while the screws are being inserted. It is also helpful to have a flashlight shining on the inside of the tables to better see the holes for alignment.
- The two tables are identical. Start with either the front or the back of the cutter.
- There are a number of screws mounted on the inside of the end caps. The ones to be removed are the second and third from the bottom. They are also the only two with washers:

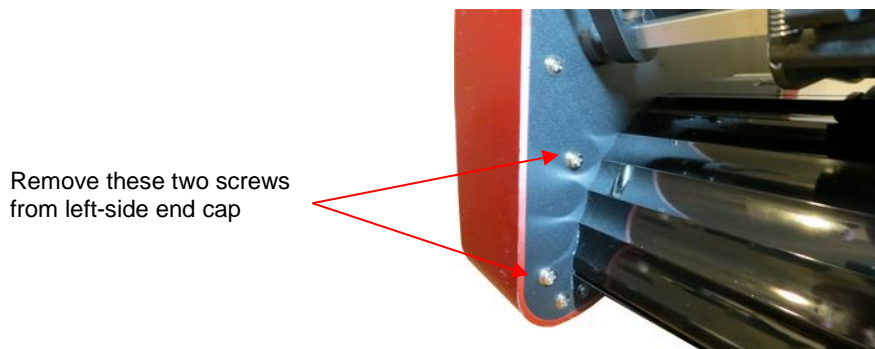
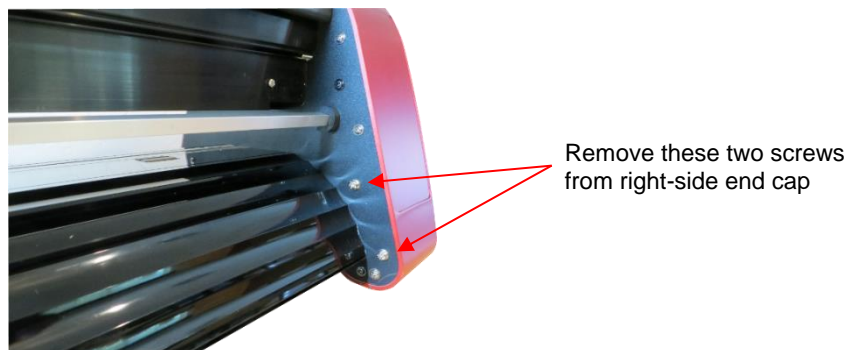

- Align the holes in the sides of the table with the holes in the end caps. Note in the following photos how the flat part of the table is on the outside:

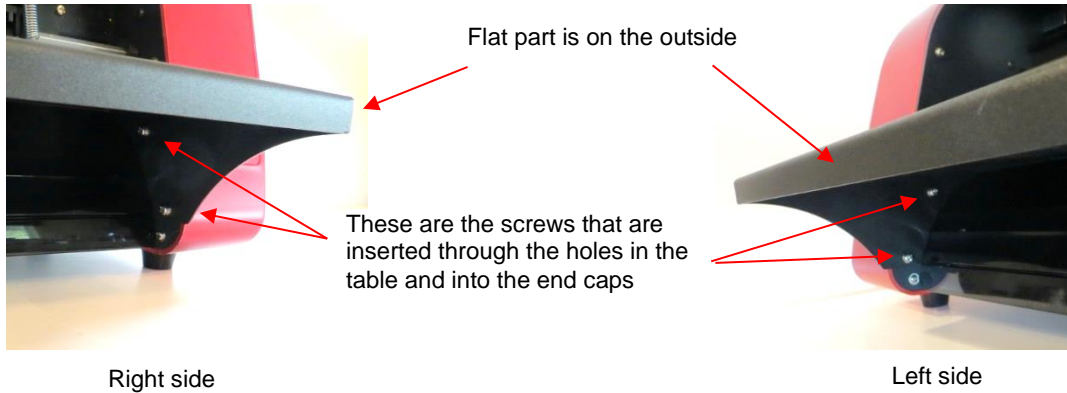

- Insert the screws previously removed through the aligned holes and screw back into place. Then repeat on the other side of the cutter.

1.07.2 Test Pen

- The test pen should be used until you are comfortable with the operation of your Skycut and know, with certainty, where images will cut. The test pen should arrive pre-assembled. However, if you want to change out the insert to the red ink insert, note how the test pen is assembled:



1.07.3 Skycut Blades

- There are three kinds of blades that fit inside the Skycut blade holder:



- ◇ The 45° **red** capped blade is suited for cutting thinner materials such as paper, all cardstock types, heat transfer vinyl, and wall/auto/decal vinyl.
- ◇ The 60° **blue** capped blade is a much longer blade and is well-suited for cutting thicker materials, such as gum paste, craft plastic, craft foam, and rhinestone template material.
- ◇ Sold separately is the 30° **yellow** capped blade. It is a wide blade and is well suited for cutting fabric, felt, and tint. It has been reported that it also works well with cardstock that has been exposed to humidity.

- Note that the red capped blade and blue capped blade have a cutback on the opposing side of the blade (right side, in the earlier photo). This reduces the blade offset value and allows for better detailed cutting of small shapes.
- Additionally, there are other tools sold separately, including a stand, an engraving tool and an embossing/scoring tool. Details on the engraving tool and embosser are covered in *Chapter 4*.

1.07.4 Blade Installation

- The blade must be carefully inserted into the blade holder. Do this over a soft surface (e.g. over a hand towel). It's important to protect the fragile blade! To install, follow the numbered steps as shown:

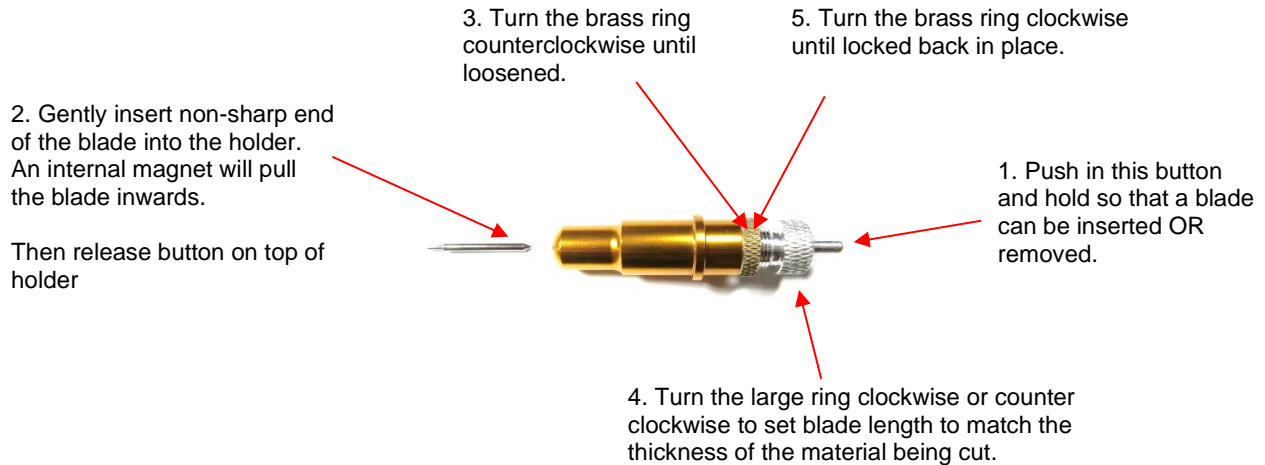

- The **Blade Length** (also called **Blade Exposure**) is how much blade is exposed at the bottom of the blade holder. For optimal cutting, you want this length to match the thickness of the material or be just a tiny bit longer.
- When setting the blade length (*Step 4* in the prior photo), hold the blade holder up next to the material before pressing the material to the mat, so that you can more accurately set the length to match the thickness of the material. For really thin materials, like vinyl and thin paper, just the very tip of the blade will be protruding from the bottom of the blade holder. In fact, you should just barely be able to feel it with your fingertip and not be able to see it very well, if at all. Having the blade fully extended will never result in better cutting. In fact, it can cause skewing, tearing of the material, damage to the blade, and damage to the mat or cutting strip.
- A good way to test your blade length is to fold a piece of the material onto itself and then cut a line into the material by hand. Press firmly but not too hard, as more force will not determine if the blade is set to the right length. If the blade cannot cut through the material, you will need to extend the blade. If the blade cuts through the material and cuts into the next layer, you need to retract the blade. If the blade cuts through the material but does not cut into the layer below, you have the perfect length.

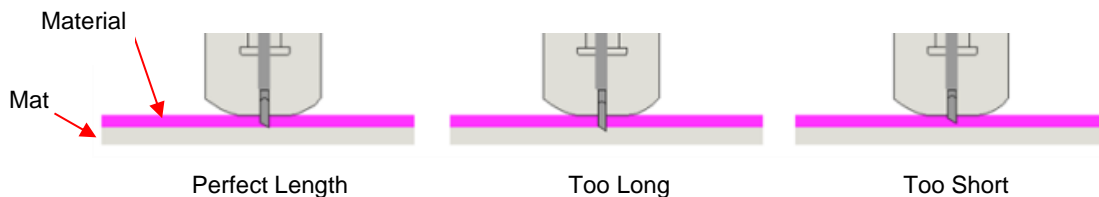

- When conducting a test cut, be sure to check your mat (or the top of a backing sheet) for cut lines after the test. You should be able to set the length to get clean cuts but with only fine lines or no lines in the mat or backing sheet. If you do see deep cut lines, retract the blade length $\sim\frac{1}{4}$ of a turn counterclockwise. Repeat your test cut.

1.08 Preparing and Caring for the Cutting Mat

1.08.1 Tips on Using the Cutting Mat

- Always use a mat to hold the material to be cut unless the material has its own protective backing. For example, vinyl and iron-on transfer both come with a layer that you do not cut. Thus, this backing layer serves as the carrier for cutting. Paper and cardstock do not have a backing, thus they must be cut on the mat.
- ***IMPORTANT!*** A new mat may be too sticky if you are cutting certain products. This can cause difficulty in removing cut items without tearing. Place an old but clean bath towel over the surface of the mat and press with a brayer or rolling pin. Then pull up. Test the stickiness by pressing the palm of your hand in the middle of the mat and lifting. If the mat remains stuck to your hand, repeat until the mat can still be lifted but will release. It should only take a few pressings to greatly reduce the stickiness, as tiny (too small to be visible) fibers from the towel are added to the surface.
- Do not leave the pinch wheels in a down position when the Skycut isn't in use. This warps the plastic sooner, shortening the useful life of the cutting mat.

1.08.2 Cleaning and Replenishing the Cutting Mat

- When mats begin to lose their stickiness, they can be washed:
 - ◇ Use a mild dishwashing detergent, warm water, and a soft brush to thoroughly clean the surface. You're not trying to scrub the adhesive but just wet the invisible fibers that have been deposited from your cutting materials and get them released from the glue.
 - Rinse well, shake off excess water, and place sticky side down onto a bath towel.
 - Thoroughly dry the non-sticky side of the mat with another towel.
 - Pull the mat up and the sticky side should now be dry enough for immediate use. Test by making sure the mat will stick to your hand.
- While washing with soap and water should revive the original adhesive, you can add more adhesive if necessary:
 - ◇ Virtually any repositionable adhesive may be used on the cutting mat. Some of the popular choices include: Krylon Easy Tack, Aleene's Tack It Over and Over (view the video at the start of this section), Crafter's Companion Stick and Spray, Zig 2 Way Glue with wide tip, Craft Smart Off 'N On, and Scotch Repositionable Craft Stick. There's another spray adhesive, Scotch Super 77, which does not leave a sticky surface but is excellent for stabilizing paper and cardstock.
 - ◇ If you are cutting thicker materials, such as oil board or styrene, then you may want to experiment with a stronger adhesive and use painter's tape to secure the material to the mat. If you are cutting thin paper, then you may want to experiment with a lighter adhesive.
 - ◇ With most repositionable adhesives, you can control the tackiness based on the amount applied. Thus, always add a little bit at a time. As mentioned above, if you add too much, just apply a layer or two of cotton fibers by pressing with a bath towel.
- Other reported methods for cleaning mats:
 - ◇ Use a plastic scraper (an old credit card will suffice) to scrape off any random material pieces remaining on the mat after a cut.
 - ◇ For finer particles of paper or lint, you can use a lint roller. Tear off a sheet and then press down and pull up across the surface of the mat to clean in sections. Baby wipes can accomplish the same task.
 - ◇ To completely remove adhesive from the mat, apply Goo Gone, Duck Adhesive Remover, or Avon's Skin So Soft Bath Oil across the surface. Allow a minute to soak in and then scrape off with a sharp metal spatula. Repeat, as necessary until the mat is thoroughly clean and no longer sticky. Wash, dry and then add any repositionable adhesive.

- When necessary, the rubber wheels and the grit shafts may be cleaned with isopropyl alcohol or Un-Du. Apply the cleaner to a clean lint-free rag and rub the entire wheel and/or grit shaft until free of adhesive.

1.09 Pinch Wheels

- The pinch wheels can be raised and lowered using the pinch lever located at the back-right side of the machine. Press down on the lever and the pinch wheels will be raised. Pull the lever up to lower the pinch wheels so that they can grip the mat or the material inserted in the cutter.
- There is also a small black lever on each individual pinch wheel. When the lever is raised, there is less downward pressure exerted. **IMPORTANT:** Only push these small levers down when an extra tight grip is needed, such as when cutting reflective film or thick chipboard. For normal cutting of most materials, it will not be required.

Lever is in up position. This is recommended for most cutting.

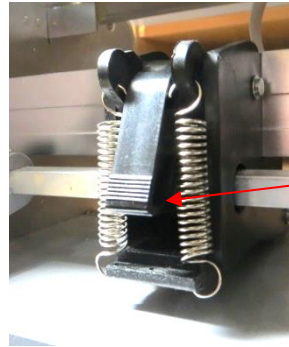
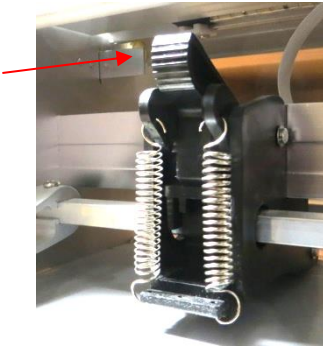

Lever is in down position. Do NOT use this position except with certain materials.

- Note that for a pinch wheel to grip properly, it must be positioned over a grit shaft. To facilitate alignment, note the white rectangles positioned along the horizontal bar behind the blade carriage. Slide the pinch wheels along the bar, as needed:

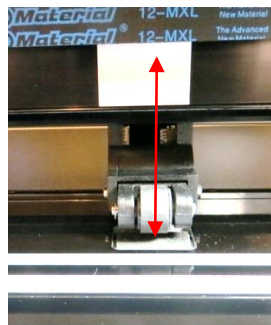

Wheels should be centered over grit shafts which are directly below the white rectangles

- When using the cutting mat, it is recommended that the material be placed in the middle of the mat and the mat placed roughly in the middle of the cutter. Then use the second and fourth pinch wheels locations for two pinch wheels. This keeps the pinch wheels off the material and provides an equal balance while the mat moves in and out during cutting:

Middle two pinch wheels are placed under 2nd and 4th white rectangles

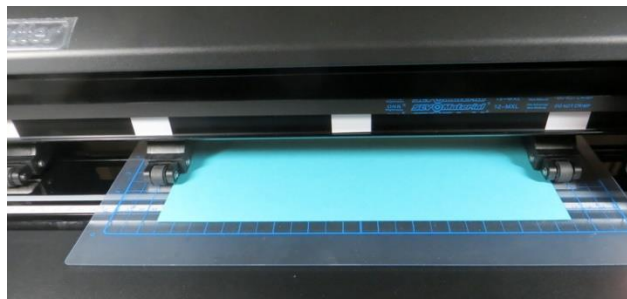

Pinch wheels are approx. the same distance from the outside edges of the cutting mat

- Note that if your material is very wide, then it is fine to have the pinch wheels over the material. However, you may need to be extra careful when removing any cut shapes or waste material in those locations.

1.10 Control Panel

- When you first turn power on the Skycut, after several seconds, the following **Main Screen** or **Home Screen** will be displayed:

Repeat last cut. While cutting, this icon and function changes to **Pause**. 

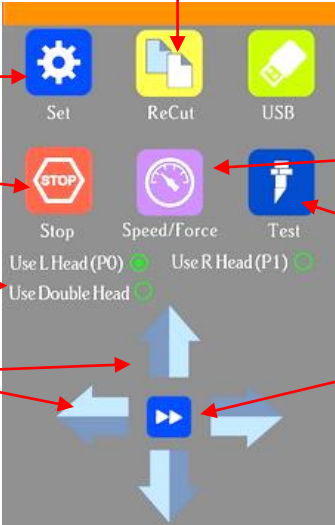

Change settings Refer to 1.10.1

Stop and cancel the current cut

Select which head to use or select **Double Head**

4 arrow keys for moving the head left/right and for moving the pinch rollers

Open and cut PLT files from an inserted USB flash drive

Set the desired speed and force.

Execute a test cut using current speed and force settings

Toggle the speed for moving the head and pinch rollers. In slow mode, the icon changes to: 

- Throughout this manual, the functions above will be referenced along with submenus and additional screens. You will also see the following icons at the bottom of many screens. Pressing the one on the left will always return you to the **Main Screen** above. Pressing the one on the right will return you to the prior window/screen.

Go back to **Main Screen/Home Screen**   Go back to prior screen

1.10.1 Set Screen

- Pressing the **Set** icon  opens the **Set Screen** which contains access to many functions and settings. Note the general description and section number (if you wish to learn more about that function now):

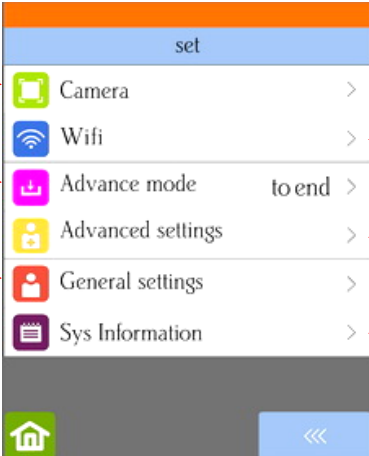

Calibrate and use camera for print and cut applications: *Chapter 3*

Set end-of-cut options: *Section 2.06*

Settings for: LED, Units, Language, Screensaver, Alarm: *Section 1.14.2*

Set up wireless connection to home or office network: *Section 1.12.2*

Array setup, Scale, and options for display and cutter behavior: *Section 1.14.2*

Version numbers, software selection, reset: *Section 1.14.3*

1.11 Introduction to SignCut Pro 2

1.11.1 Installing SignCut

- SignCut Pro 2 can be downloaded from the following link:

<https://signcutpro.com/#download-section>

- In some cases, a virus protection software may warn users that there are potentially dangerous files. It is perfectly safe to install this program so temporary changes or disabling of your virus protection program may be required. After installing SignCut Pro 2, you can reestablish your virus protection.
- The program can be used without purchase for three weeks, as long as SignCut2 has not been previously installed on that computer.
- Note that three programs will be installed:
 - ◇ SignCut Pro 2 (the program you will use for cutting)
 - ◇ SignCut Draw (a program you can use for designing – PC version only)
 - ◇ SignCut Spooler (a program you can use for managing completed jobs).
 - ◇ You can also import a range of vector file formats into SignCut Pro 2 if you prefer to design in a different vector program.
- Unlike prior versions of SignCut, license numbers are not used. For identification of your registration, an **Alias** name is used which appears in the **Title Bar**. To change your **Alias**:
 - ◇ Go to **Account>My Account** and click on **My Signcut** (left side).
 - ◇ You will then see an **Edit Alias** button to click which will open a window where you can enter a new **Alias**. Click on **Save**.
 - ◇ Close and reopen SignCut Pro 2. Your name **Alias** name should now appear in the **Title Bar**.

1.11.2 Sign Cut Screens

- The following screenshots provide labels for the various parts of SignCut Draw and Sign Cut Pro. It's worthwhile noting the names of these parts as they will be referenced throughout this user manual.

SignCut Draw:

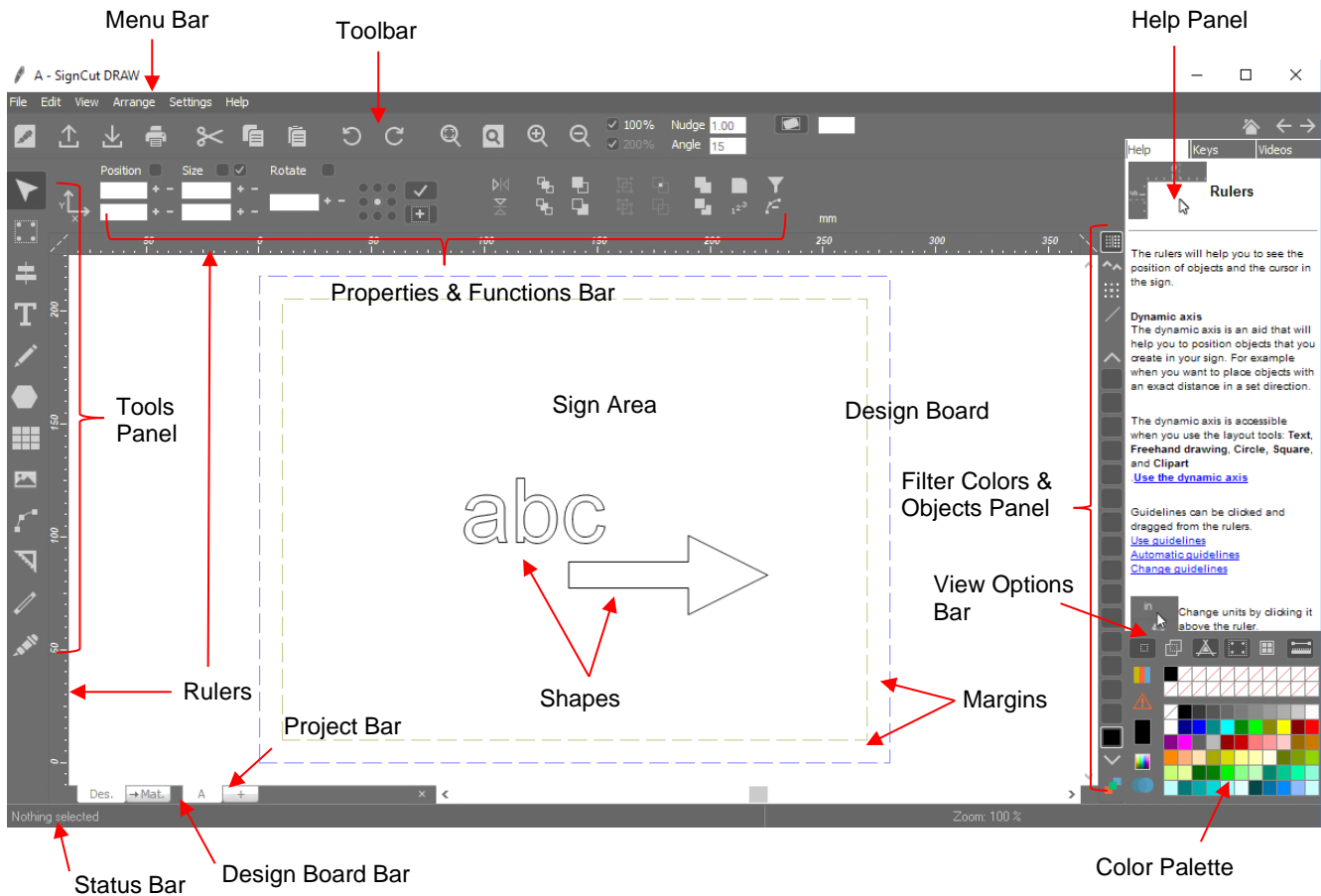

- Hovering your mouse over most of the screen icons will pop up the icon's name and available shortcut.
 - ◇ While the shortcuts are shown with uppercase letters, use lowercase keys on your keyboard when executing.
 - ◇ On the **Tools Panel**, the shortcut keys (top to bottom) are in the same order as the alphanumeric keys on your keyboard (left to right: **Q, W, E, R, T, Y, U, I, O, P, A, S**). When needing to switch back and forth between any two tools, double-clicking an empty part of the **Sign Area** will toggle between the last two tools used.
 - ◇ Note that in some cases, as with functions on the **Tools Panel**, a shortcut key can be followed with a number to provide even faster access to a function plus one of its options on the **Properties and Functions Bar**. These shortcuts are written in this manual as, for example, **E1**, where you would press the "E" key, release, and then you would press the number "1". With other shortcuts, such as **Ctrl+S**, the "+" indicates you hold down the first key while pressing the next (i.e. hold the **Ctrl** key while pressing the **S** key).
 - Alternatively, you can repeatedly press one of the letters to cycle through the options for those particular tools.
 - ◇ Any shortcut with the letter "F", such as **F1, F2, F3**, etc., refers to your keyboard's function keys along the top.
- In order to better remember where major elements are located, note that the term "bar" is used when components are laid out horizontally (such as the **Toolbar**) and the term "panel" is used when components are laid out vertically (such as the **Tools Panel**).
- The **Design Board** refers to the entire white space available for placing shapes. The **Sign Area** refers to the portion inside the blue dashed lines. The **Margin** area is between the green dashed lines and the blue dashed lines.

- **Shapes** are the objects or images that you will be adding to your projects. They can be created from scratch or imported from other sources.

SignCut Pro2:

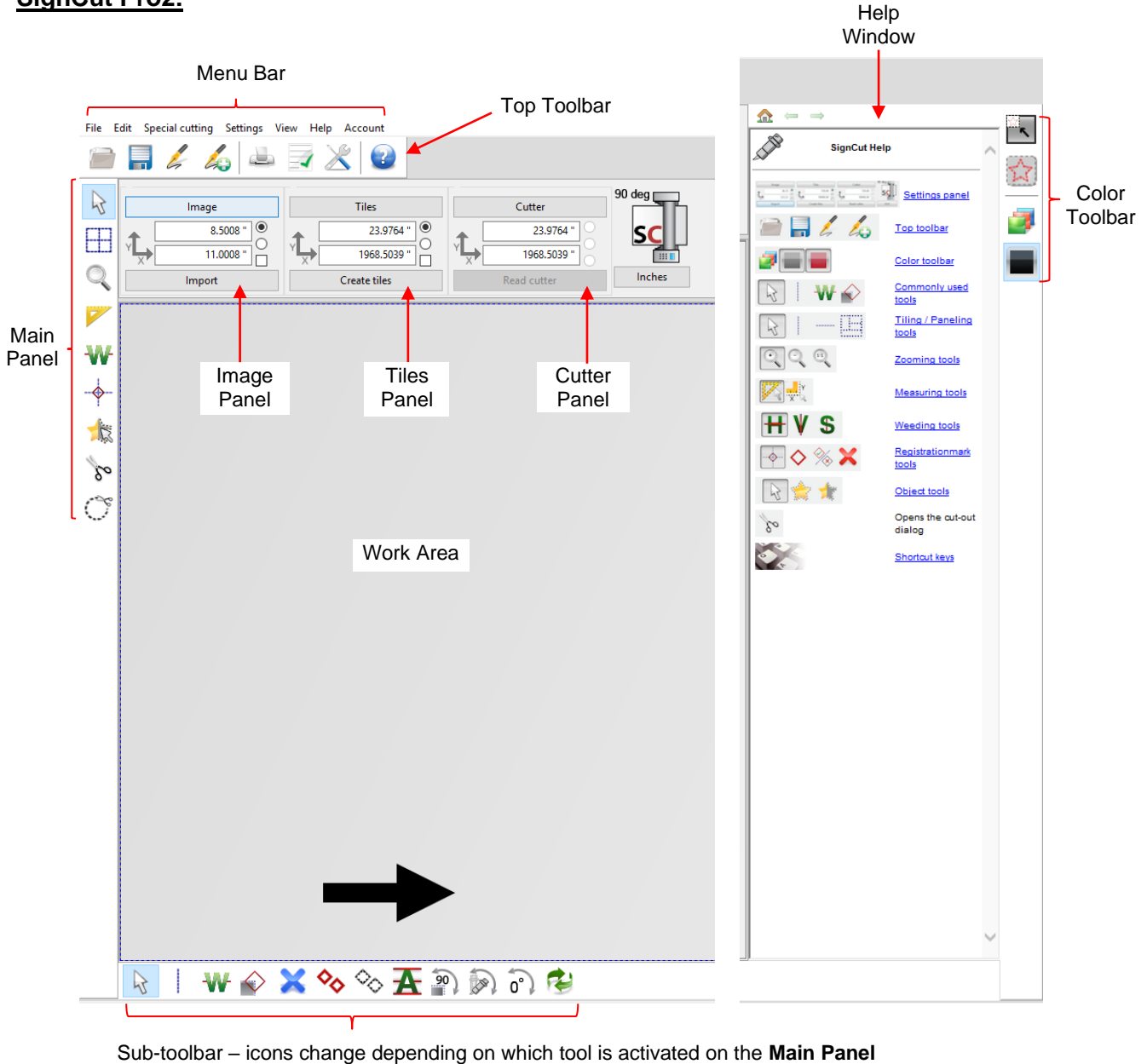

- Hovering your mouse over most of the screen icons will pop up the icon's name and available shortcut.
- On the **Main Panel**, the shortcut keys (top to bottom) are in the same order as the top row of alphanumeric keys on your keyboard (left to right: **Q, W, E, R, T, Y, U, I, O**).
- On the **Sub-toolbars**, the shortcut keys are in the same order as the bottom row of alphanumeric keys (left to right: **Z, X, C, V**, etc.).

1.12 Connecting the Skycut to Your Computer

- Place your Skycut on a sturdy horizontal surface. If using the cutting mat, be sure to allow enough free room in both the front and the back for the mat to extend during cutting.

- **Powering On:**
 - ◇ Plug the power cord into a wall outlet or power strip. Connect the power cord to the Skycut D on the left side end cap.
 - ◇ Turn on the power using the power button that is also on the left side end cap. After several seconds, the light inside the Skycut will turn on and the head will do a slight jog.
- You have four options for sending files and information from your computer to the Skycut:
 - ◇ **Direct USB** using the included USB cable
 - ◇ **Wi-Fi** – adding the Skycut to a home/office network that is also accessed by your computer
 - ◇ **Wireless Standalone** – connecting wirelessly to your computer
 - ◇ **U_Disk** - Exporting PLT files from SignCut Pro2 onto a USB flash drive and then loading those files using the control panel on the Skycut.
- Review the information in the following table to understand the differences between these options. Note that implementing any of these options does not preclude you from changing to another one, as needed.

Connection Options for the Skycut with SignCut Pro

<u>Option</u>	<u>USB</u>	<u>Wireless to Network (Wi-Fi)</u>	<u>Wireless Stand-Alone</u>	<u>USB Flash Drive</u>
<u>Description</u>	The Skycut is connected to the computer via a USB cable	The Skycut is wirelessly connected to a network router	The Skycut is wirelessly connected to the computer.	Files are saved in PLT format from SignCut to a USB flash drive
<u>Requirements</u>	USB cable (included)	Wireless network router and knowledge of router's name and password	Computer must have wireless capability	USB flash drive
<u>Pros</u>	Easy to install; Reliable and fast form of communication.	Skycut can be located anywhere within range of the router; Other computers can cut to the Skycut	Skycut can be located anywhere within range of the computer; Other computers can cut to the Skycut	Skycut can be located anywhere
<u>Cons</u>	Skycut is physically connected to the computer; Cannot be accessed by other computers at the same time	Requires more steps to set up; Some routers may require setting changes in order to work with the Skycut	Computer is now connected to the Skycut, thus no <u>wireless</u> access to the Internet or to other wireless devices	More steps due to saving and then loading the file; Cannot adjust size and certain cut settings once saved

- The following sections present what steps are required for each type of connection. If you run into connectivity issues, please contact your dealer.

1.12.1 USB Connection

- Power on the Skycut and wait for the white light status. Connect the included USB cable into the Skycut's USB port and into a USB port on your computer.
- Open SignCutPro and click on the **Cutter** button near the top of the screen:

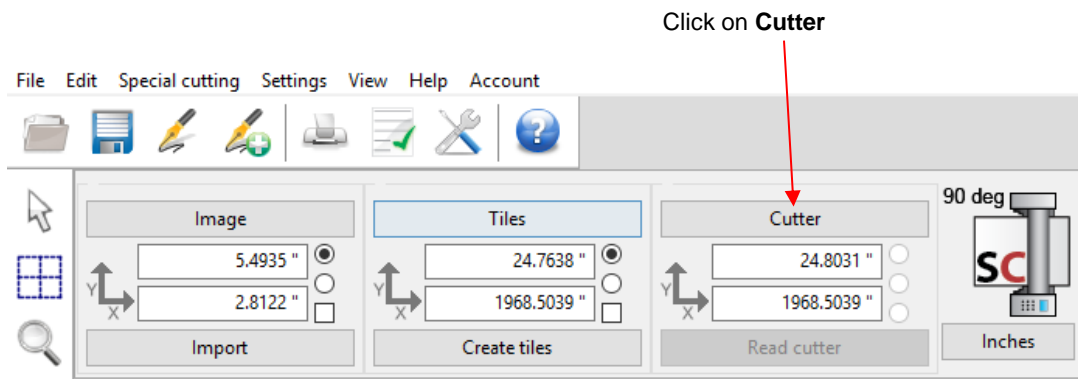

- The **Cutter** window will open. From each drop-down menu, select the **Manufacturer**, **Cutter**, and **Output Device/Port** as follows:

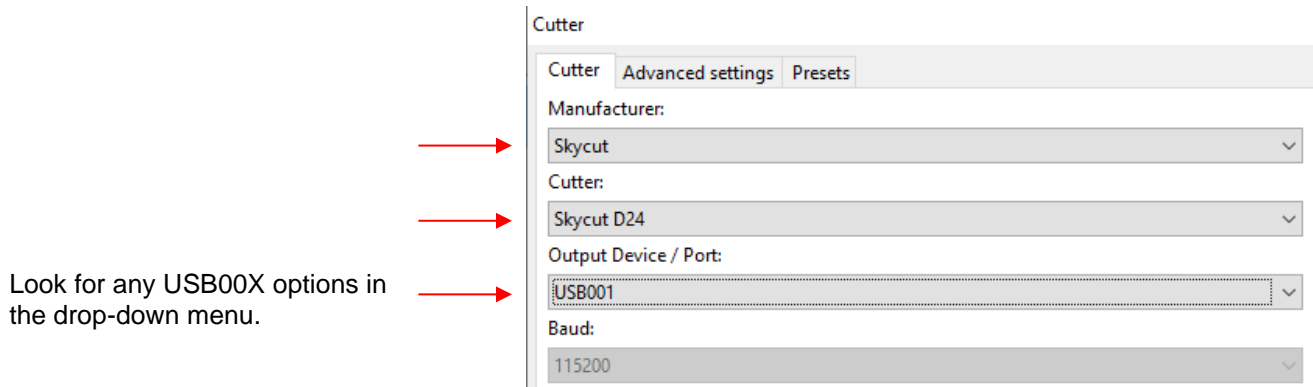

- Click on **Ok** to close the **Cutter** window and proceed to *Section 1.13*.

1.12.2 Wi-Fi Connection

- Note: Not all routers have the same signal strength. It's usually best to connect the Skycut while it is in the same room with the router. Once connectivity is established, you can then experiment to see how far from the router the Skycut can be located.
- What you'll need:
 - ◇ Name of your home/office network
 - ◇ The password for your network
- Carefully complete the following steps:

(1) On the Skycut's control panel, select **Set**  and then select **Wifi**. The **Wifi screen** will appear:

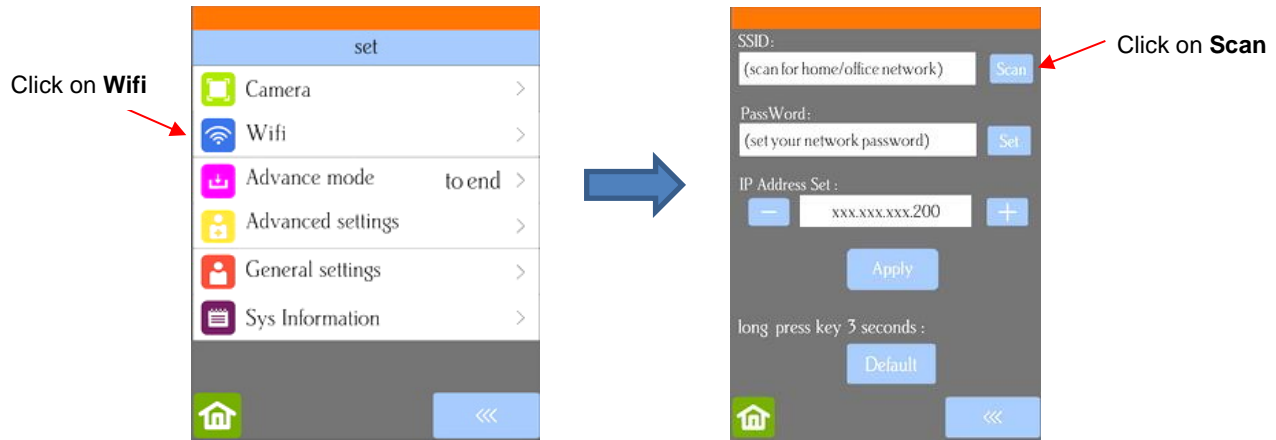

(2) Click on the **Scan** button and a list of the available networks will appear. Select your home/office network and click on **Apply**. You will then be returned to the **Wifi** screen:



(3) Click on **Set** and the following screen will open:

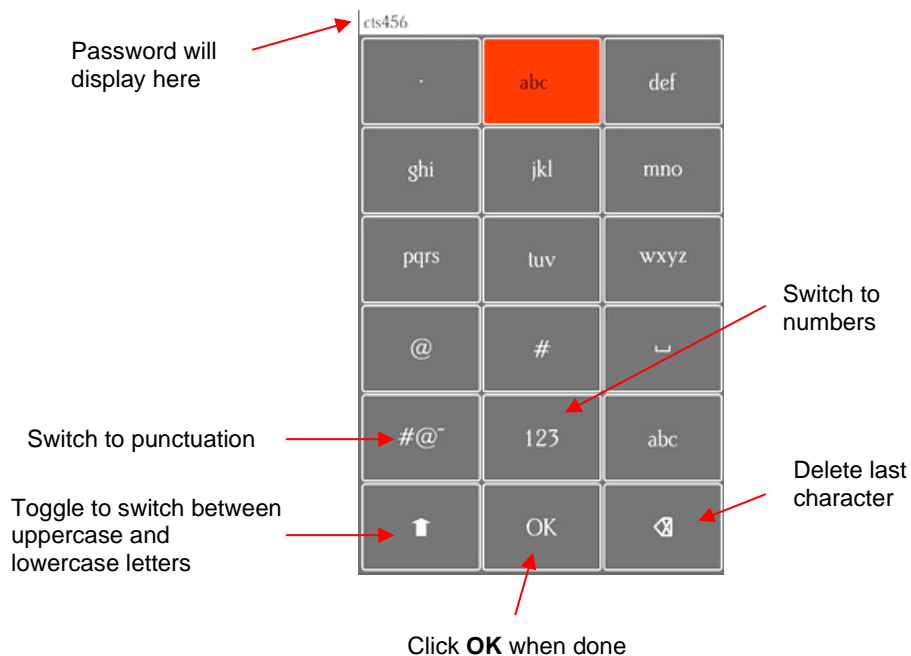

- (4) To enter the password, use the following tips if you are unfamiliar with this type of screen:
 - ◇ “Rapid tap” multiple times in succession to select a letter. For example, if your network password is *cts456*, then to enter “c”, you would tap three times on “abc” because “c” is the third letter in “abc”. Next you would proceed to “stu” and tap two times to enter “t”. Then you would only need to tap on “stu” once to enter the letter “s.”
 - ◇ To enter numbers, click on “123” to open the number entry screen.
 - ◇ For punctuation, click on “#@~” to open the extra characters screen.
 - ◇ To enter upper case letters, click on the up arrow in the lower left part of the screen.
- (5) Once you have the password entered in the display box at the top, click on **OK** to return to the **Wifi** screen:



- (6) Next check the **IP Address** that will be assigned to the Skycut. The Skycut will automatically pick up the first three sets of digits from your router but will continue to display them as shown above. You only need to decide if the last set, which should be defaulting to “200”, can be used. Use the “+” or “-” buttons to make any needed changes.
- (7) Click on **Apply** and wait for several minutes while your router assigns this **IP Address** to the Skycut. Eventually, you will see **Connected OK** appear:



- (8) If instead of receiving a **Connected OK** display, you see **Password err**, again verify the network you selected and the password you entered. If you are unable to successfully connect and the Skycut is within a few feet of your router, please check your router’s user manual and/or search online for issues with your particular router model.
- (9) If you wish to reset and start again, press and hold the **Default** button for 3 seconds until the button turns red. Then click on **Scan** and repeat from *Step 3*.

- (10) Once you receive the **Connected OK** display, open SignCut Pro and click on the **Cutter** button near the top of the screen:

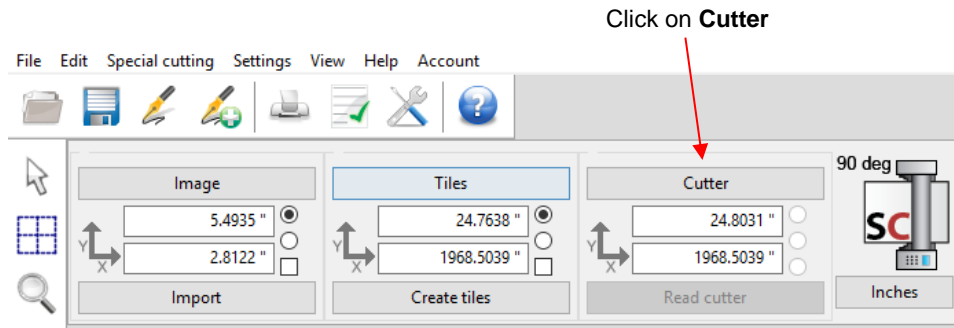

- The **Cutter** window will open. From the drop-down menus, select the **Manufacturer** and **Cutter** as shown:



- In the drop-down menu for **Output Device/Port**, select **TCP/IP** and a new window will open. In that window, enter the same **IP Address** you selected earlier on the Skycut's control panel. Also, enter **8080** for the **Port** assignment:

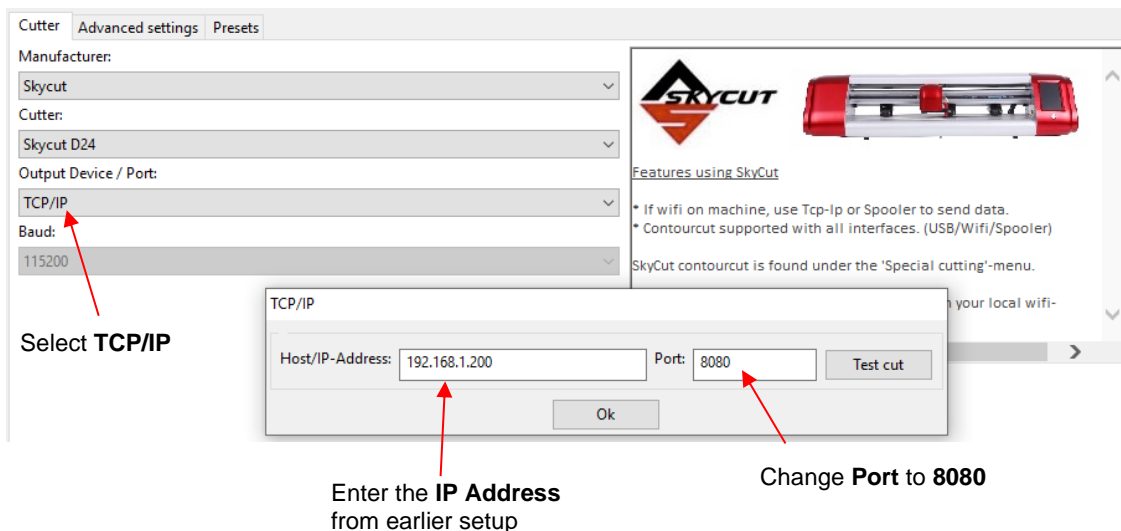

- Click on **Ok** to close the **TCP/IP** window and **Ok** again to close the **Cutter** window. Proceed to *Section 1.13*.

1.12.3 Wireless Stand-Alone

- It's usually best to connect the Skycut while it is next to the wireless computer. Once connectivity is established, you can then experiment to see how far from the computer the Skycut can be located.
- There are two situations to consider before getting started. If you are not sure which applies to your Skycut, then select *B* and go to that section first.
 - The Skycut has never been set up wirelessly to a network.
 - The Skycut has previously been connected to a wireless network.

A. The Skycut has never been set up wirelessly to a network

- Power on the Skycut and wait for the light to come on.
- On your computer, open your list of available networks. In the list, you should see one with this type of name format: *HI_LINK_XXXX* where “XXXX” can be any alphanumeric combination, such as “92BF” or “08A5”.
- Select that network and enter the following **Network Key** when prompted: 12345678.
- In SignCut Pro, click on the **Cutter** button near the top of the screen:

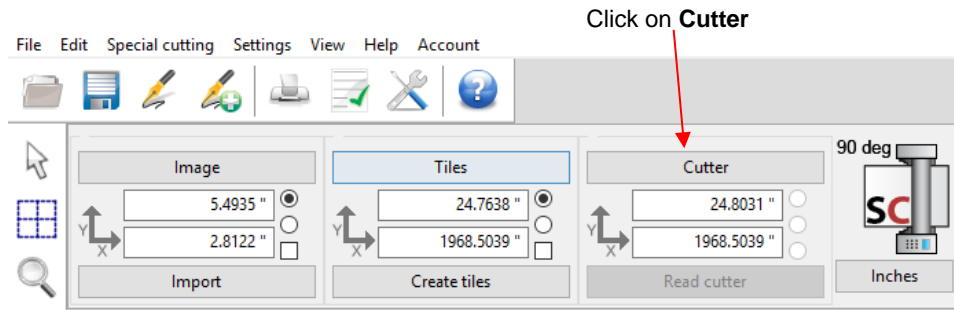

- The **Cutter** window will open. From the drop-down menus, select the **Manufacturer** and **Cutter** as shown:

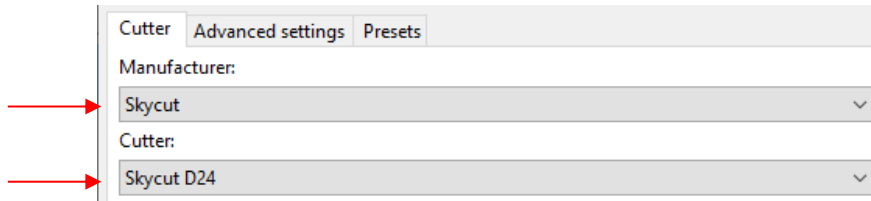

- In the drop-down menu for **Output Device/Port**, select **TCP/IP** and a new window will open. In that window, enter **192.168.16.254** as the **IP Address**. Also, enter **8080** for the **Port** assignment:

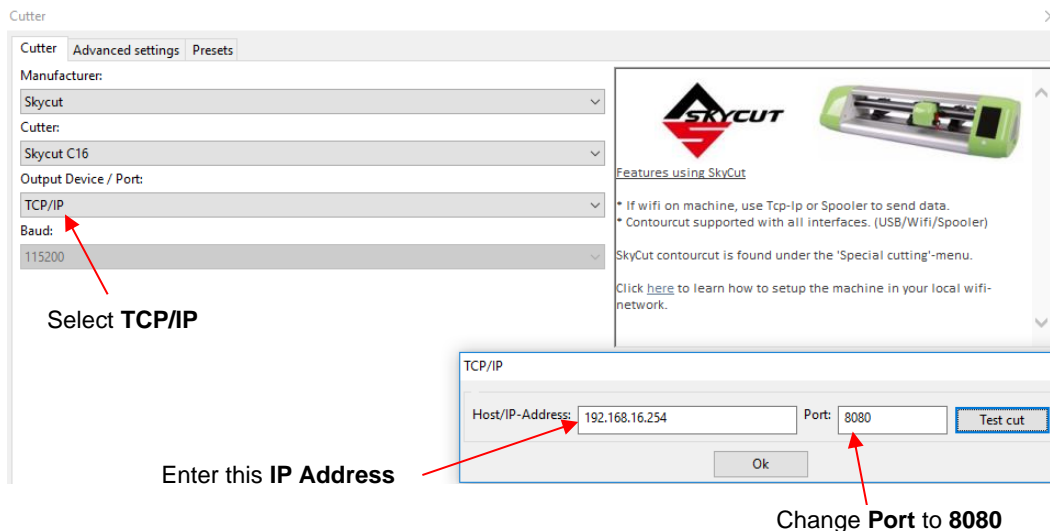

- Click on **Ok** to close the **TCP/IP** window and **Ok** again to close the **Cutter** window. Proceed to *Section 1.13*.

B. The Skycut has previously been connected to a network

- On the Skycut's control panel, select **Set**  and then select **Wifi**. The **Wifi screen** will appear:

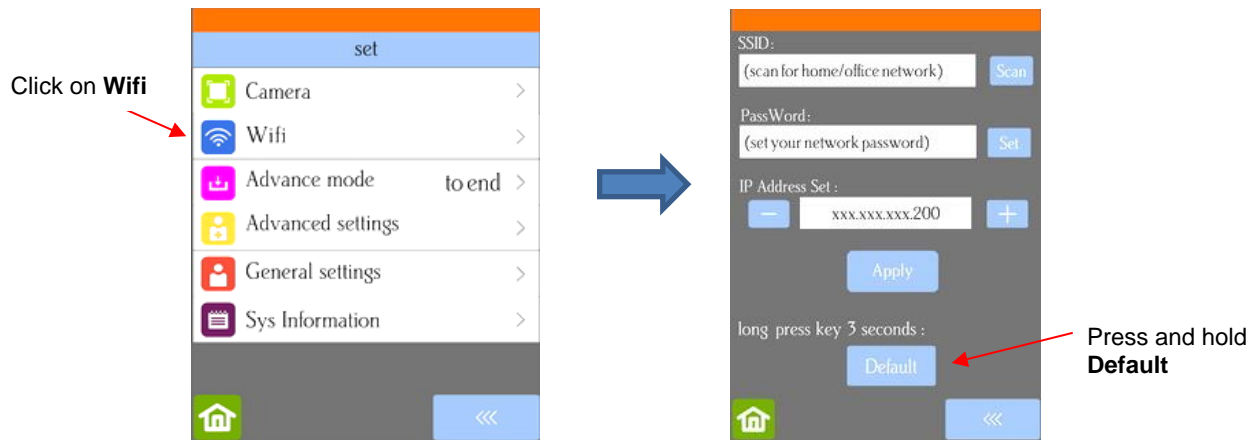

- To reset the Skycut so that it will be found as an available network, press and hold the **Default** button for 3 seconds. Release and you should see the **Apply** button now displaying **Wait**. In a minute the **Apply** should return and you can then proceed back to A. The Skycut has never been set up wirelessly to a network and use the same procedure as if the Skycut was never set up on a network.

1.12.4 USB Flash Drive

- With a USB Flash Drive connection, you will normally follow the steps presented in this section. If you are new to SignCut Pro and/or to your Skycut, it is recommended that you go to *Section 1.13* now and set up a test file using the steps presented there. In that section you will be instructed when to return here to complete the steps needed to export your file onto a flash drive.
- Insert a USB flash drive into your computer and allow your computer to find it. Note the drive letter assigned.
- If you plan to primarily use the USB flash drive option, complete this next subsection to make it the default connection setting in SignCut Pro. Otherwise, skip to the subsection called *Exporting a File as PLT*.

Setting the USB Flash Drive as the default connection

- Click on the **Cutter** button near the top of the screen

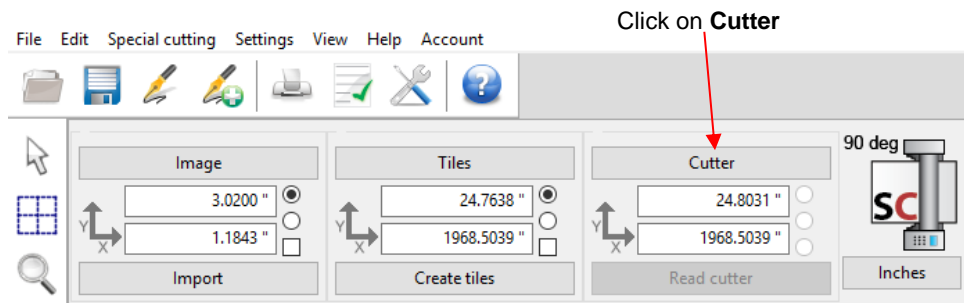

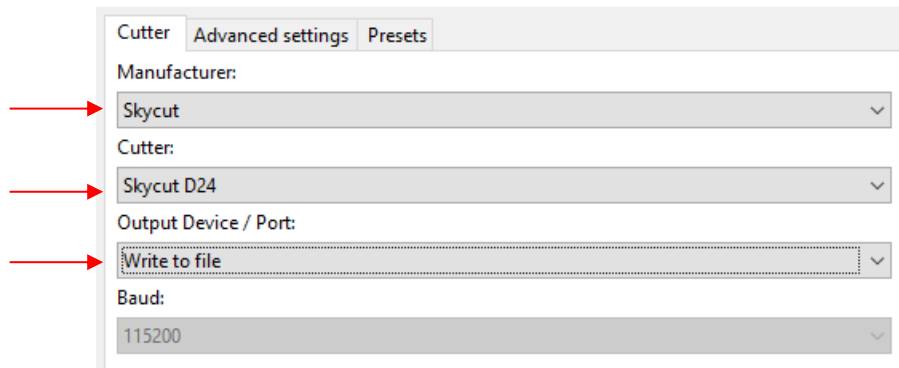

- The **Cutter** window will open. From each drop-down menu, select the **Manufacturer**, **Cutter**, and **Output Device/Port** as follows:



- Click on **OK** to close this window.

Exporting a file as a PLT

- To export/save the cut file as a PLT on a flash drive do one of the following:
 - ◊ If you set up **Write to file** as the default, then click on the **Cut out** icon  (or use the shortcut I)
 - ◊ If your default is a different connection, but you wish to use **Write to file** in this case, hold the **Shift** key and click on the **Cut out** icon 
- The following window opens. Browse to locate the USB flash drive you plan to use and name your PLT file:

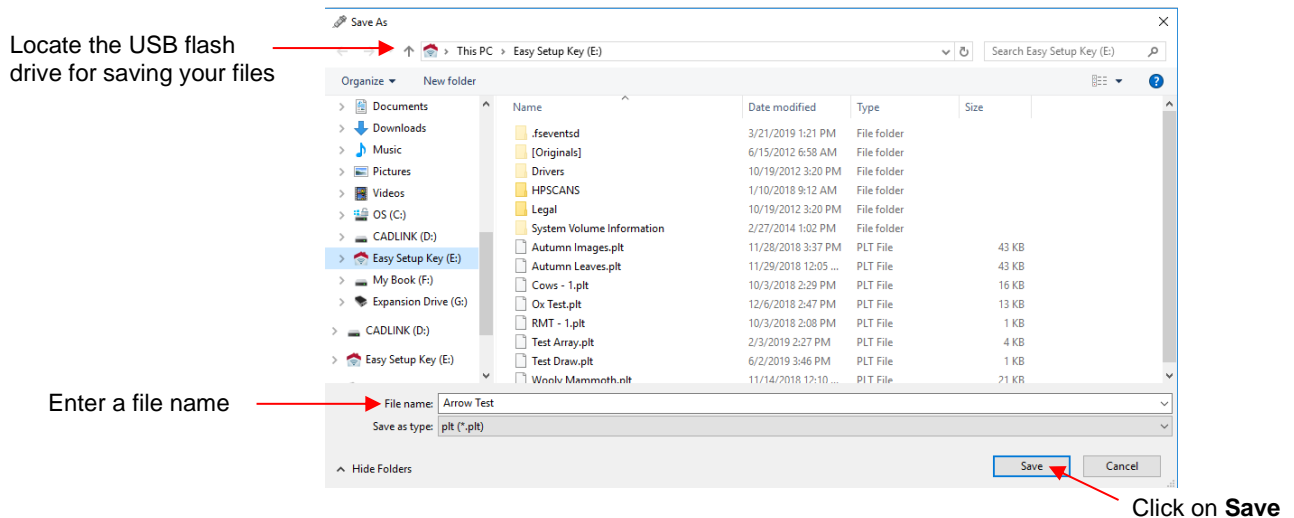

Click on **Save**

- After saving the file, eject the flash drive and insert it into the USB port on the right side of the Skycut. On the control panel, select **USB** and then **Open File**:

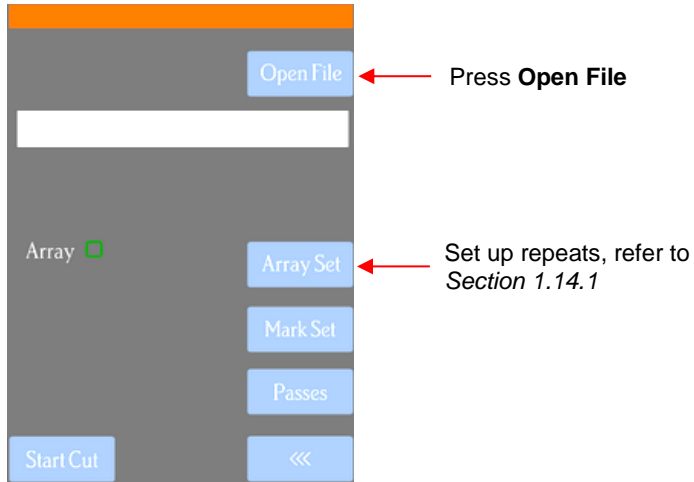

- (1) Double tap on **USB DISK** and a screen will open showing any folders and PLT files on the flash drive. Double tap a folder to open it, as needed. Drag the scroll bar on the right to see more files:



- (2) Once you have located the PLT file you want to cut, double tap the name. You will be taken back to the USB screen and the selected file name will be displayed:

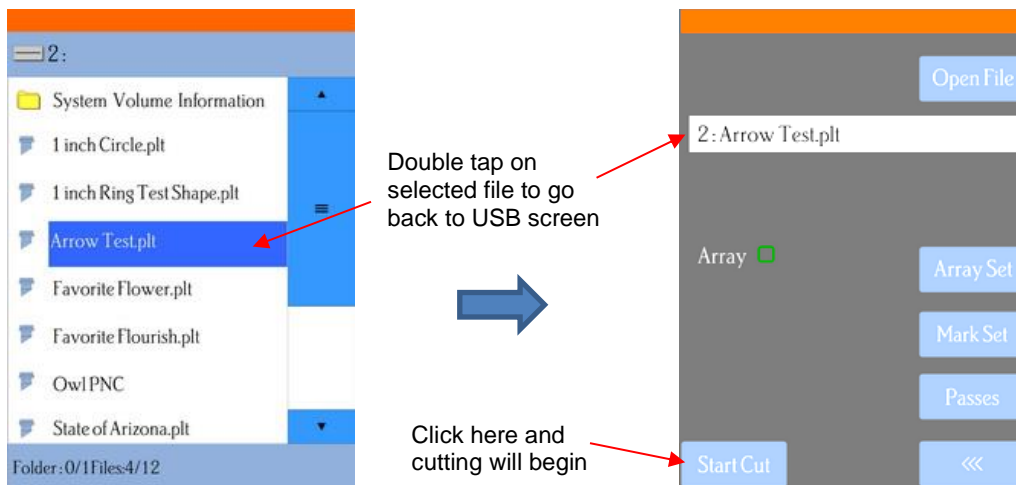

- (3) If you wish to cut repeats of the file, select **Array Set** and a screen will open where you can then select the number of rows and columns of repeats, along with the spacing between the repeats. Refer to *Section 1.14.1*.
- (4) If your project is a print and cut (aka contour cut) application, please refer to *Section 3.07*.
- (5) When you are ready to cut, click on **Start Cut**.

1.13 Test Draw Shapes

- New owners tend to be VERY eager to try out their Skycut. It's important to test your cutter to ensure that data is being sent properly from your computer to the cutter. The following steps will allow you to do some testing with the pen tool. But note that **the following steps are for DRAWING, not cutting**. Before inserting the blade holder into your cutter, please read the following *Sections 1.07.2, 1.07.3, 2.01-2.03*.

1.13.1 Inserting the Paper and Setting the Origin

- You have two options when using the test pen:
 - ◇ Insert a sheet of paper directly into the cutter. Make sure the paper is past the ruler so that it doesn't catch when feeding the paper forward:

Observe how pinch wheels are centered with white rectangles

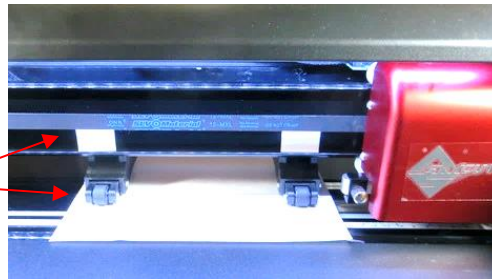

- ◇ Or...Place the paper onto the cutting mat and then insert the cutting mat into the cutter:

Observe how pinch wheels are centered with white rectangles

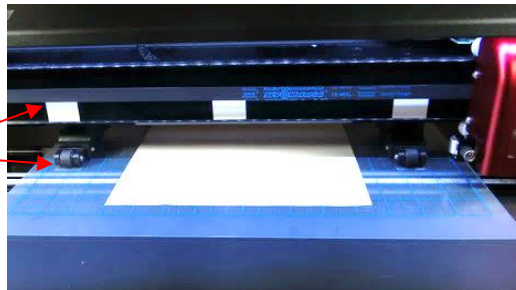

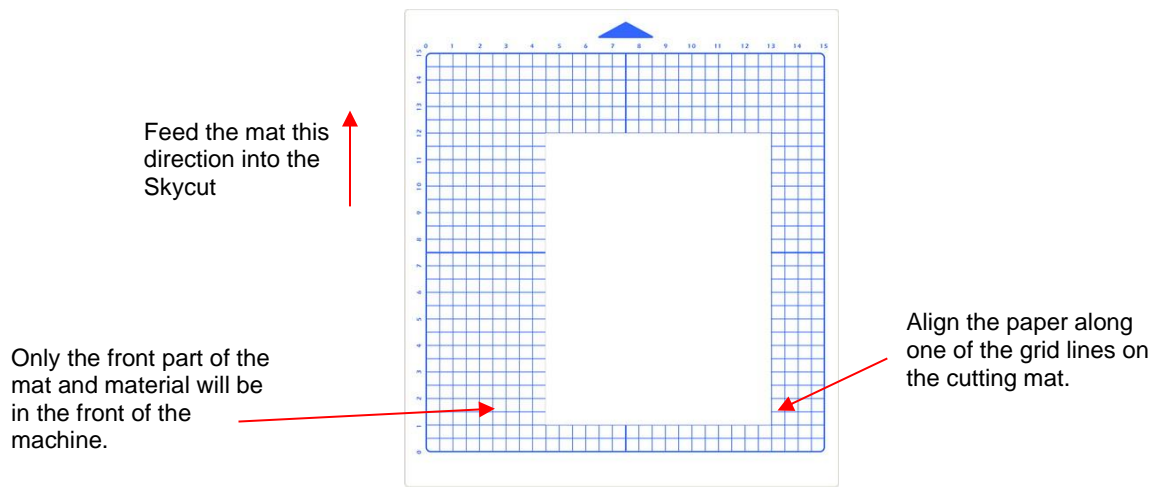

- Use any of the horizontal markings at the front of the Skycut (such as the ruler) to align the mat so that it's straight. Lift the pinch lever to drop the pinch wheels onto the cutting mat. Most of the mat and the paper should now be behind the cutter, not in the front.
- Before installing the test pen, make sure the pen will write by scribbling on scrap paper. Note that you will probably need to remove a tiny bit of wax on the end of the pen nib. Then follow these steps:
 - ◇ Loosen the screw on the left-side blade holder seat, which is considered the “default” side.
 - ◇ Insert the blade holder allowing it to freely rest on top of the paper.
 - ◇ Before tightening the front screw, raise the test pen up a little bit (~ 1/8” or several mm). You don't want the pen still touching the paper but you also don't want the pen too high above the paper either.
 - ◇ Tighten the front screw to lock in the test pen. Be careful not to push down on the blade holder seat while tightening.

IMPORTANT! This is NOT the recommended method for loading the blade holder into the cutter. This is presented as a quick way to insert the test pen so that it is in a good position for drawing. The instructions for inserting the blade holder will be covered in *Section 2.01.3*.

- The arrow keys on the Skycut's control panel will always be used to set the origin for cutting:

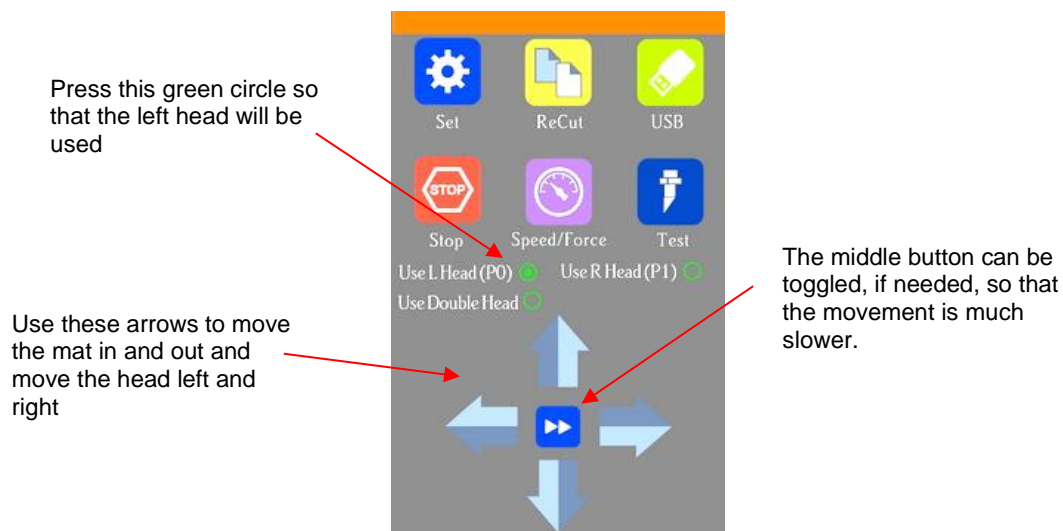

- ◇ Click on the buttons or the arrow keys on your keyboard to move the head left or right and the mat in and out. The goal is to have the tip of the pen close to the lower right corner of the paper:

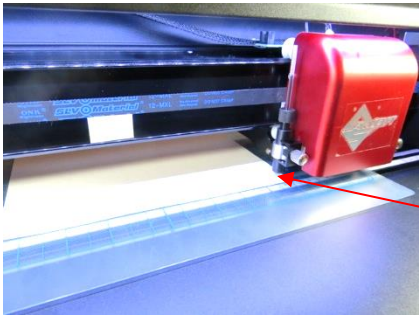

Move pen tip to this corner of the paper.

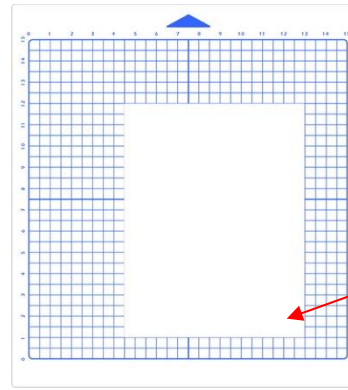

Feed the mat this direction into the Skycut

Move the pen tip to this corner of the paper

- ◇ Once the pen tip is near the lower right corner, you are ready to proceed with the test.

1.13.2 Default Settings in SignCut Pro

- Before creating a test shape in SignCut Draw, there are several settings to verify in SignCut Pro so that your results will match what is shown in this and other tutorials:
 - ◇ Shapes can always be rotated before cutting. However, you may have a personal preference regarding how projects transferred from SignCut Draw appear upon opening in SignCut Pro. To set this, go to **Settings>Settings** (in SignCut Pro) and select the **Default Folders** icon. Mark or unmark the **Rotate image 90 degrees** setting, as desired. For now, this tutorial will leave this setting unmarked:

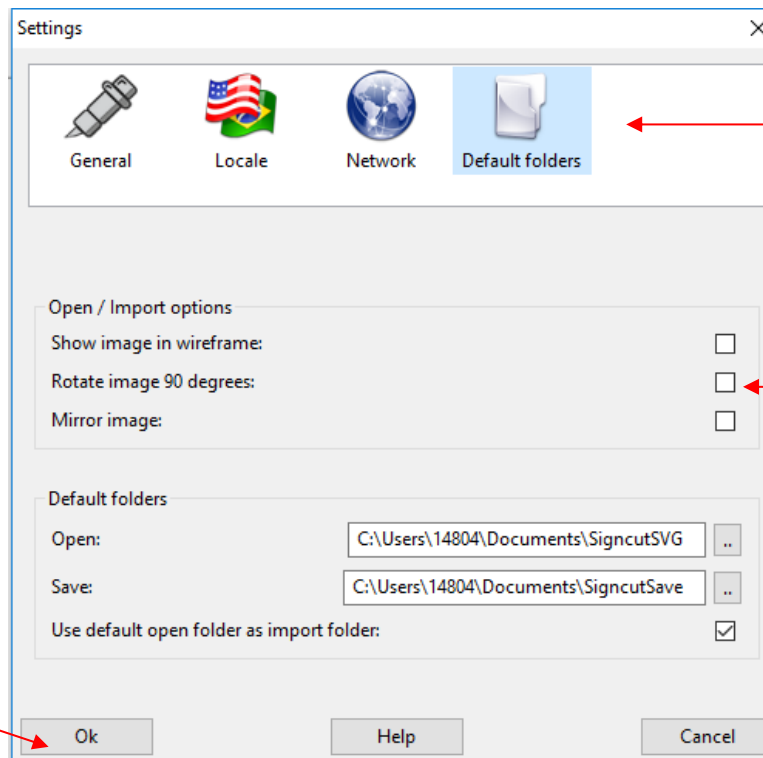

Select **Default folders**

Uncheck the **Rotate** option

Click on **Ok**

- ◇ Another setting to verify before proceeding with the testing and all subsequent cutting is to verify that the correct rotation is set for your Skycut. To do this, go to **Cutter>Settings** and click on the **Advanced settings** tab. Verify the **Rotate** setting is set to **90 deg**:

Click on **Advanced settings**

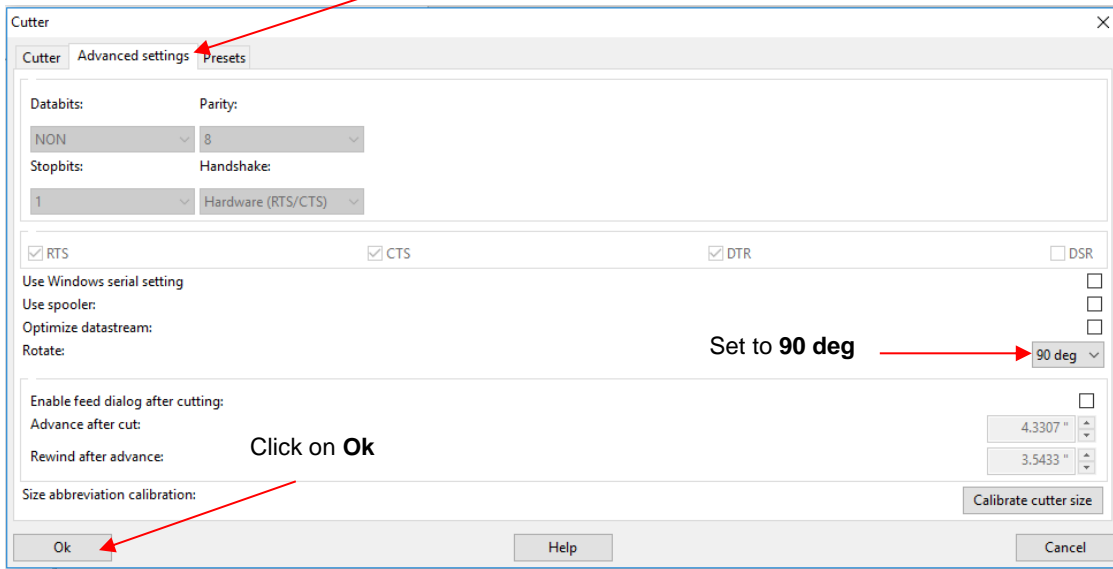

- ◇ The third setting is at the top of the **Color toolbar** on the right side of the screen. This tutorial will cover both options but, for now, click the top icon to the **Whole Area** setting (if needed) so that it looks like the one in the following screenshot. Note that the icon below it controls whether closed shapes display filled or in wireframe mode. Either option for this setting is fine since it does not affect where the shapes draw or cut:

Set to this icon

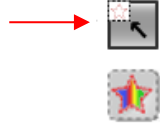

Toggle between wireframe and filled, as desired

1.13.3 Adding a Test Shape to Draw

- Open SignCut Draw and, on the left side **Tools** panel, click on the **Sign Setup** icon  or press the shortcut key **W**. In the **Properties & Functions Bar** above the **Sign Area**, you will see the following:



- Mark the **Size** option and other settings will appear. From the **Presets** menu, select **Letter** or **A4** or whatever size of paper you are using for testing. Set the **Margins** to 0. Click on the **checkmark** icon to **Apply**:

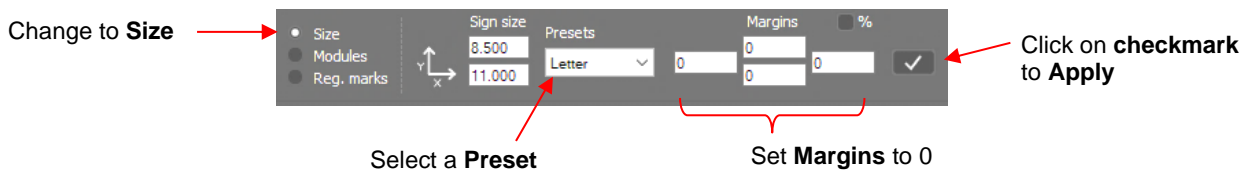

- On the left side **Tools** panel, click on the **Shape tool** icon  or press the shortcut key **Y**.
- In the **Properties & Functions Bar** at the top there will now be an assortment of shapes from which to select. The arrow is the best choice because it's important to learn the orientation of shapes on the screen

relative to where they will be drawn/cut by the Skycut before you begin cutting actual projects. Click on the **Arrow** option:



- Left click once in the **Sign Area** and then move the cursor towards the right and down to create an arrow which points towards the right. Left click again to complete the arrow:

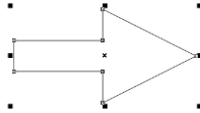

- If you wish to resize the arrow, drag any of the square handles around the selected arrow. On the **Properties & Functions Bar**, the **Height** and **Width** of the arrow will be displayed:

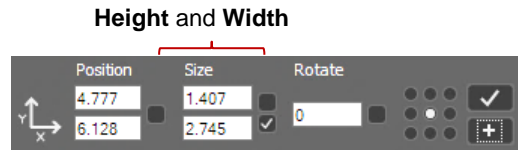

- Alternatively, you can enter new measurements into those fields, if you wish. Uncheck the **Proportional** option if you want to separately change **Width** and **Height**. When done, click on **Apply**:

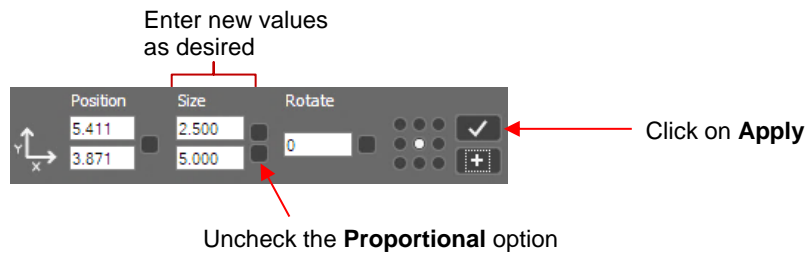

- To position the arrow, drag it to any location within the **Sign Area** boundaries. Note that if you are still in the **Shape tool** mode, you'll need to drag the shape by having your mouse cursor on the center X. Otherwise in **Object edit** mode, you can drag anywhere within the shape:

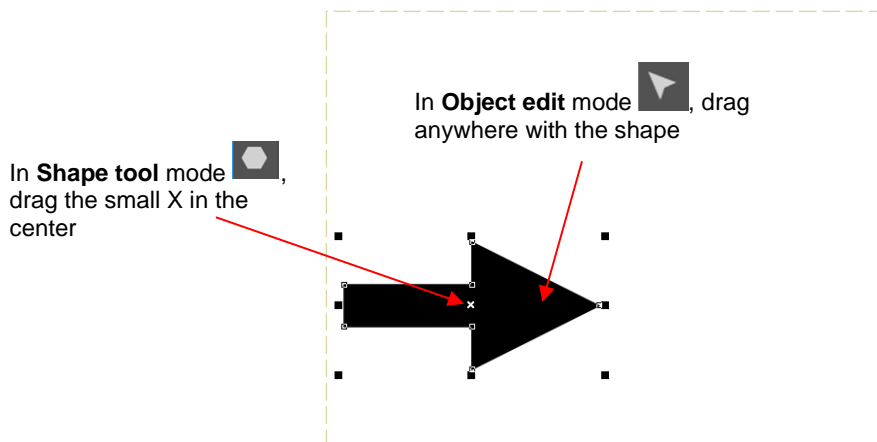

- To send this arrow to SignCut Pro for drawing, click on the **Move Image to SignCut** icon  (bottommost icon) on the **Tools** panel or press the shortcut key **S**.
- SignCut Pro will open and the arrow will be displayed:

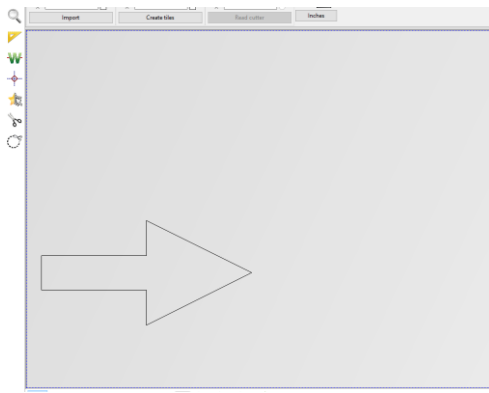

Wireframe mode

Or...

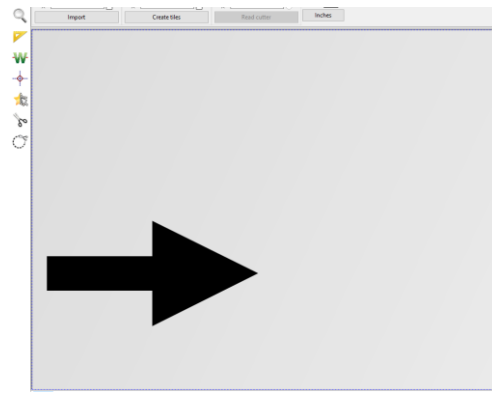

Filled mode

1.13.4 Drawing the Shape from SignCut Pro

- Click on the **Cut Out** icon  (second from bottom) on the **Tools** panel. The following window opens:

This is a weed border around the shape

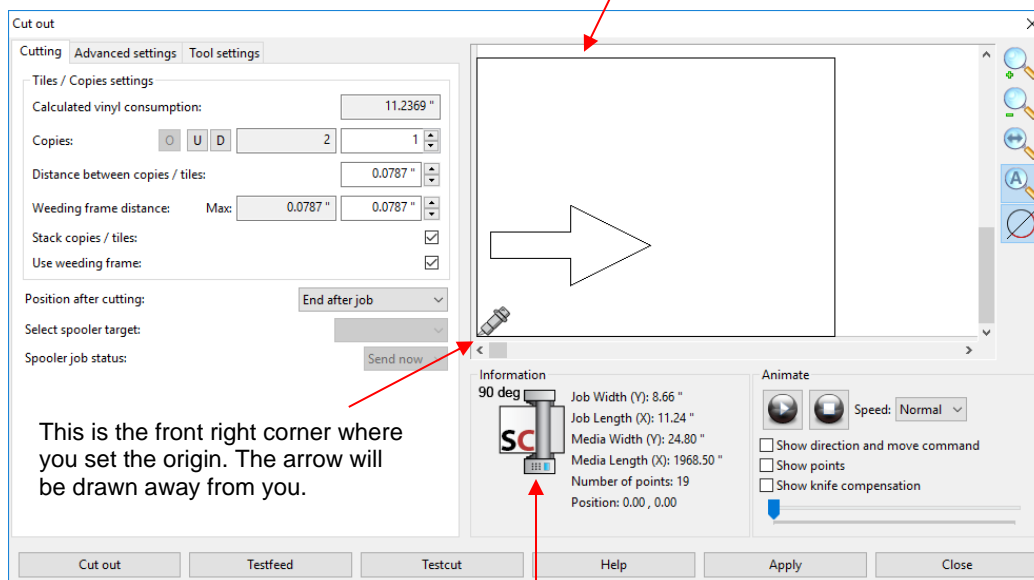

This is the front right corner where you set the origin. The arrow will be drawn away from you.

This image of a cutter indicates how the preview above is oriented.

- A few items to note about this window:
 - ◇ The top right portion of the window shows a preview of the arrow and the orientation in which it will be drawn relative to the origin you set on the Skycut (which is represented by the blade holder image). In this case the arrow will be pointing upwards as you face the Skycut.
 - ◇ As a reminder of the orientation, the image of a cutter below the preview will remind you that the top of the preview corresponds to the left side of the cutter and the bottom of the preview corresponds to the right side of the cutter (as you face the cutter).
 - ◇ There is a weed border option that is probably checked by default. Since this is a test draw, turn off the weed border by unchecking the **Use weeding frame** option:

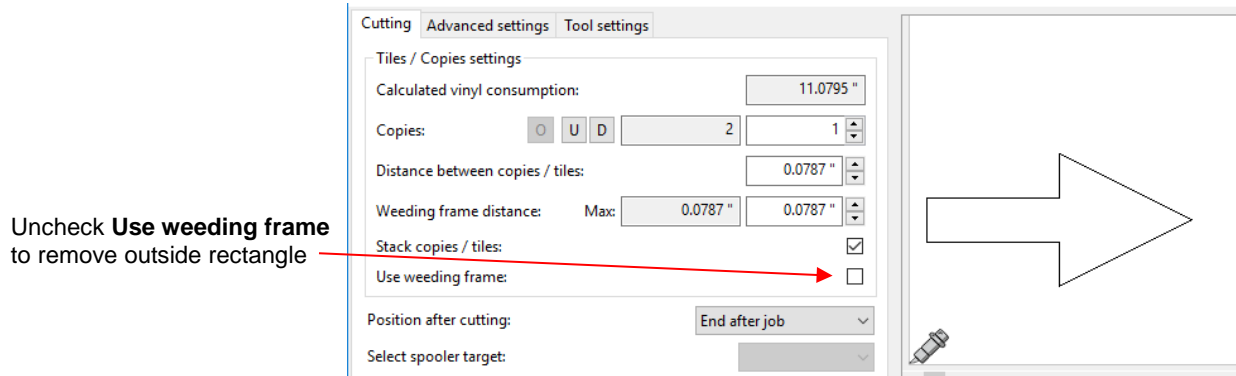

Uncheck **Use weeding frame** to remove outside rectangle

- Click on the **Tool settings** tab. The following window opens where you can enter the settings for drawing with the test pen. Note that with the Skycut, you also have the option to enter settings on the control panel instead.

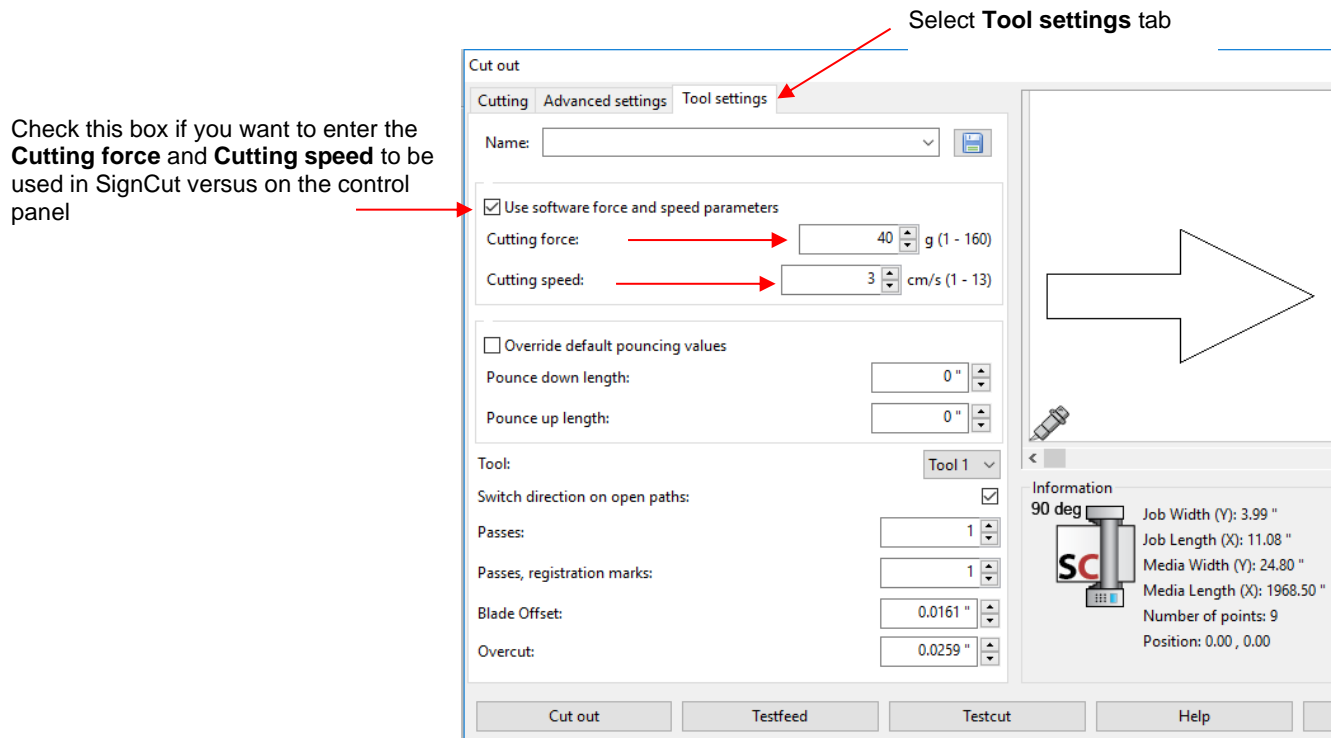

Check this box if you want to enter the **Cutting force** and **Cutting speed** to be used in SignCut versus on the control panel

Select **Tool settings** tab

- At this point, if you plan to export this file to a USB flash drive, rather than cut directly to the Skycut from SignCut Pro, please go to *Section 1.12.4* for instructions. Otherwise, click on **Cut out** and the Skycut will draw the arrow on your paper:

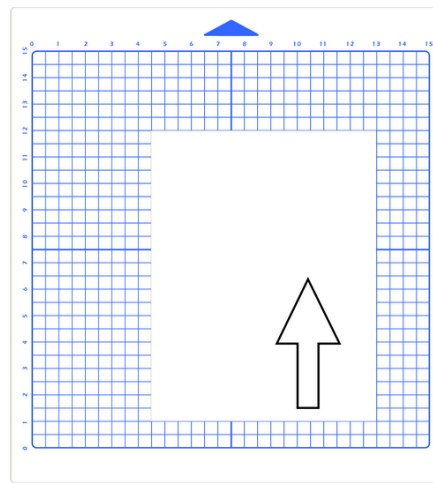

↑
Feed the mat this direction into the Skycut

The arrow is drawn in the same location as in the **Work Area** and points upwards

- You'll note that the arrow is drawn in the same location as it was positioned in the **Work Area**. Often, however, users will prefer to save on material and have shapes cut as close as possible to the origin set on the material. To do this, click on the top icon on the right-side **Color toolbar** to switch from **Whole area** mode to **Optimized** mode:

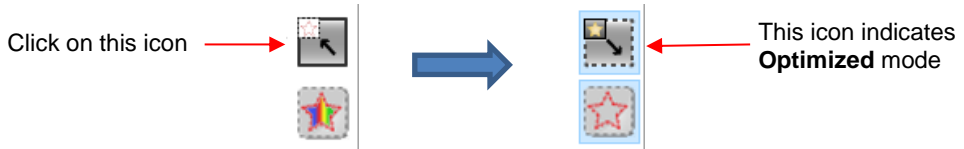

- You'll note that the shape now fills the **Work Area** boundary. However, the arrow is still the same size. It's just been enlarged on the screen the new **Work Area** is the bounding box around that shape instead of the **Letter** size originally selected in SignCut Draw:

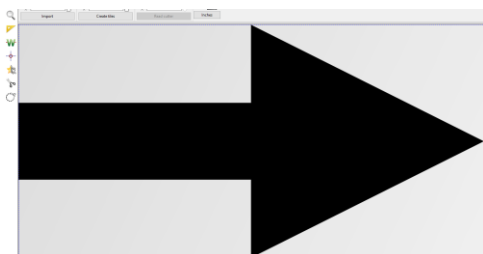

- Click on the **Cut out** icon  and you'll observe that the boundary around the shape is now aligned with the origin:

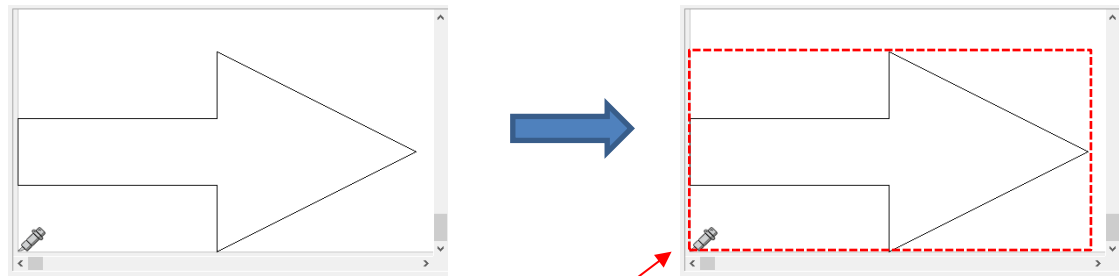

Corner of bounding box around shape is now aligned with the origin

- Draw with this setting and the arrow is now moved to the origin:

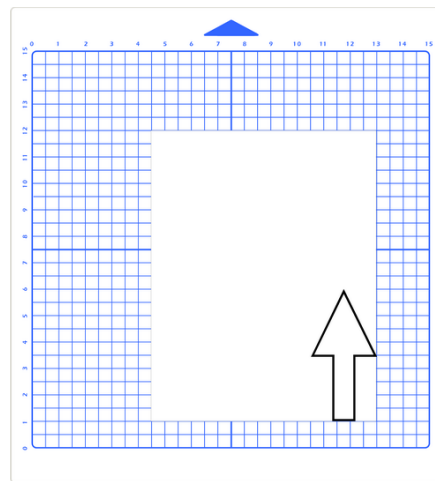

Feed the mat this direction into the Skycut

The arrow is drawn at the origin and points to upwards

- If you want the arrow to draw so that it points towards the left instead of upwards, click once on the **Rotate 90 degrees** icon  on the **Sub-toolbar** at the bottom of the screen. The main screen, cut preview and resulting drawing of the arrow will result in this:

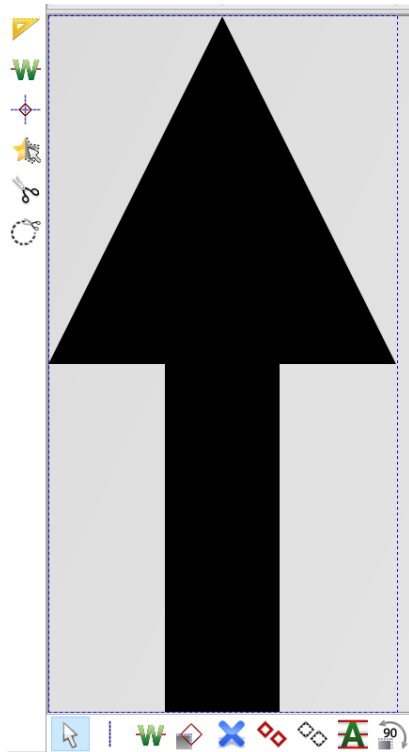

Click here to rotate

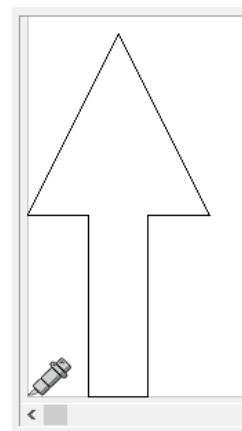

The preview indicates the arrow is rotated

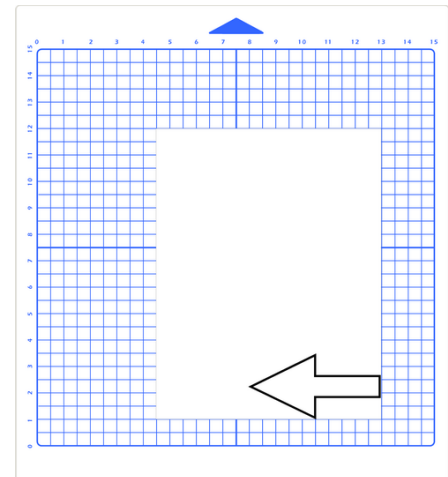

The arrow is drawn at the origin and now points to the left

- Subsequent clicks of the **Rotate 90 degrees** icon will continue to rotate the arrow. Continue practicing with this and other shapes until you feel confident you understand the correlation between what you see on the screen and what actually gets drawn. Also, refer to *Section 2.02.2* for more details on controlling where images will cut.

IMPORTANT: Please read *Section 2.01* before cutting!

1.14 Default Settings To Consider

- The Skycut's control panel offers a number of default settings. Some of these may not be important at this point in the learning process. So, you may want to skip this section for now but remember that it's here and could provide you some options to improve your experience with the Skycut.
- Each of the following sections will refer to one of the settings in the **Set** screen.

1.14.1 Advanced Settings

- The optional settings in the **Advanced Settings** screen are:

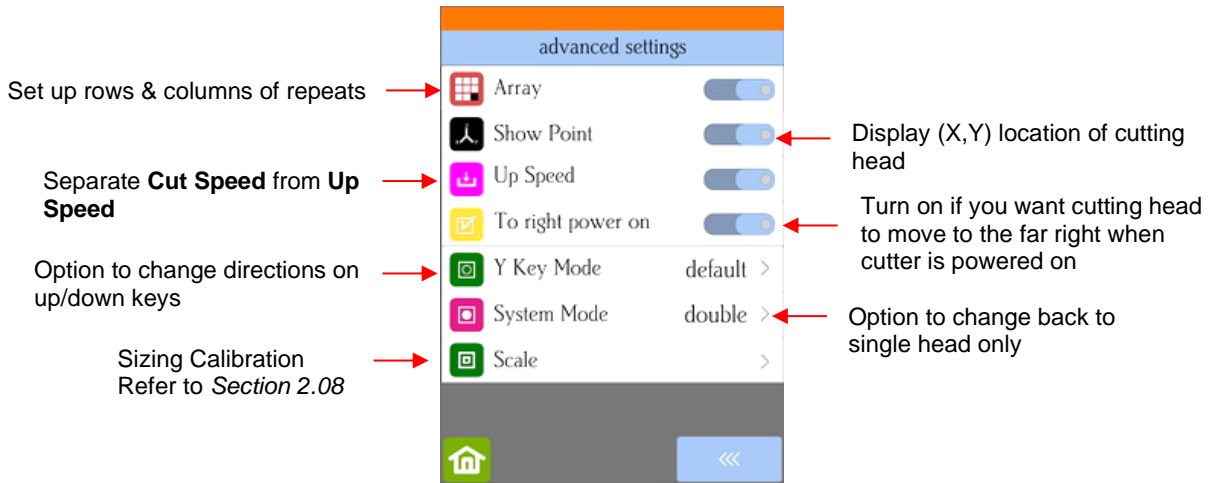

- Array:** Tap the **Array** button to open the **Array** screen:

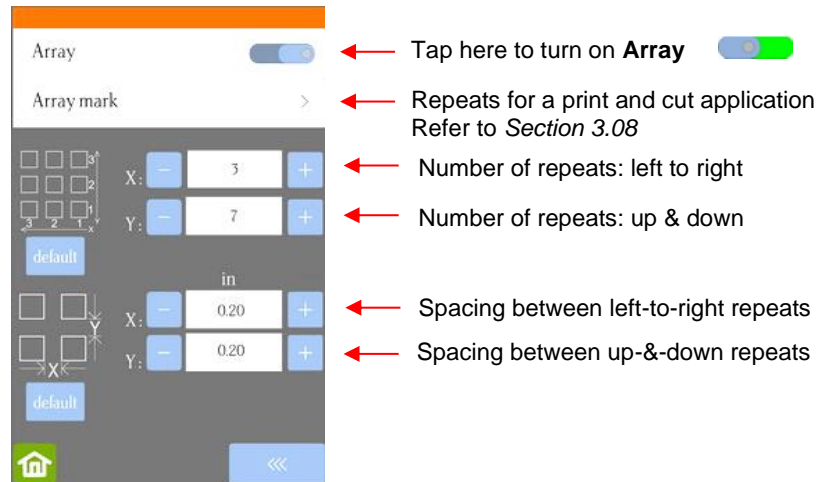

◇ In the above screenshot, the shape sent to the Skycut would cut 3 across and 7 up & down, for a total of 21 shapes. The spacing between each shape would be 0.20 inches (Note: to use mm instead of inches, switch the **Units** setting. Refer to *Section 1.14.2*).

- Show Point:** When toggled on, the **Main Screen** displays movement and location output based on the position of the cutting head:

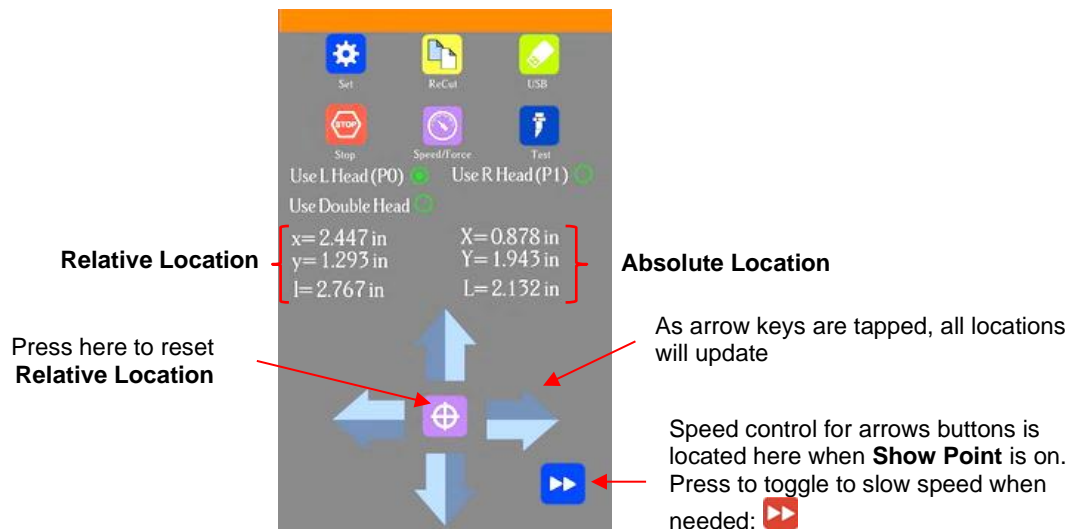

- ◇ **Absolute Location** displays the current location relative to a “power-on” location of (0,0):
 - **X** is the left-to-right location
 - **Y** is the up-&-down location
 - **L** is the straight-line distance from (0,0)
- ◇ **Relative location** displays the change in location currently being made as you press the arrow keys:
 - **x** is the current left-to-right distance moved from **X**
 - **y** is the current up-&-down distance moved from **Y**
 - **l** is the straight-line distance from the (**X,Y**) location
- **Up Speed** is how fast the blade travels while in the “up” position, such as when it is moving from the origin to the location of the first shape to cut or when moving from one cut shape to begin cutting another. When turned off, **Up Speed** will match the **SPEED** set for cutting. Turning on this setting will change the **Speed/Force** screen to display both speeds, allowing them to have different settings:

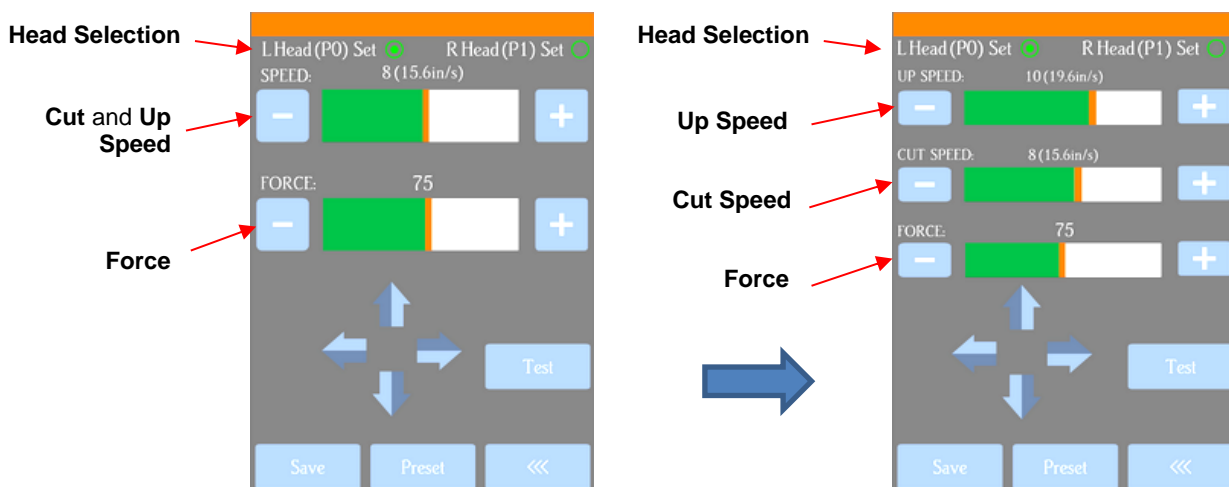

- **To right power on:** With this setting turned on, the cutting head will move to the far right whenever the Skycut is powered on.
- **Y Key Mode:** This setting controls the movement of the material or cutting mat when using the up and down arrows in the **Main Screen**:

Pressing an **UP** arrow will move the material forward

Pressing a **DOWN** arrow will move material towards the back of the cutter

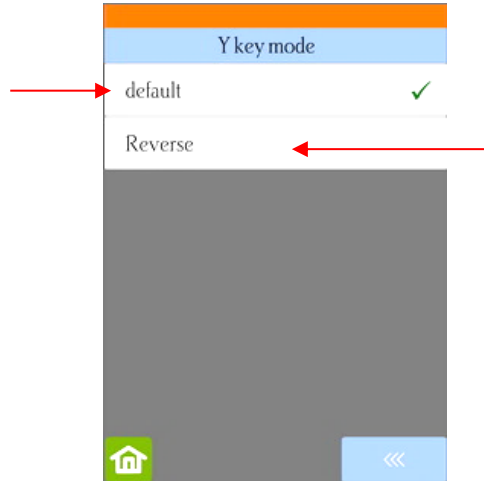

Pressing an **UP** arrow will move the material towards the back of the cutter

Pressing a **DOWN** arrow will move material forward

- **System Mode** is used to select whether or not the dual head options are available on the main screen:

Normal cutting/drawing with just a blade holder or test pen on the left side

Option to use both heads

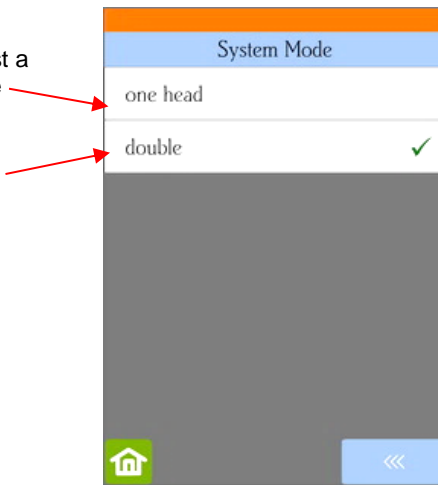

- **Scale** is used to input the sizing calibration. Refer to *Section 2.08*.

1.14.2 General Settings

- The optional settings in the **General Settings** screen are:

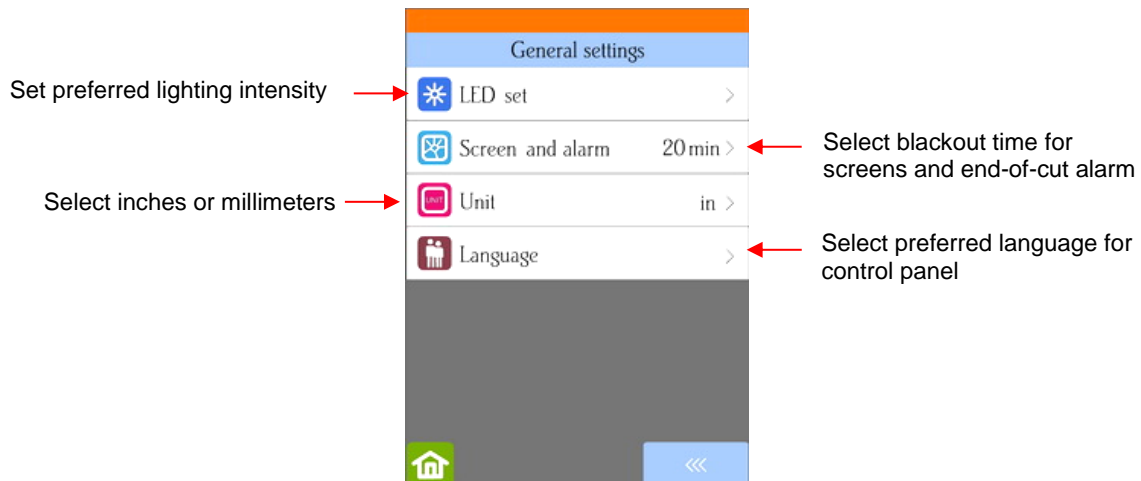

- **LED set** allows you to change the brightness of the light inside the Skycut or even turn it off:

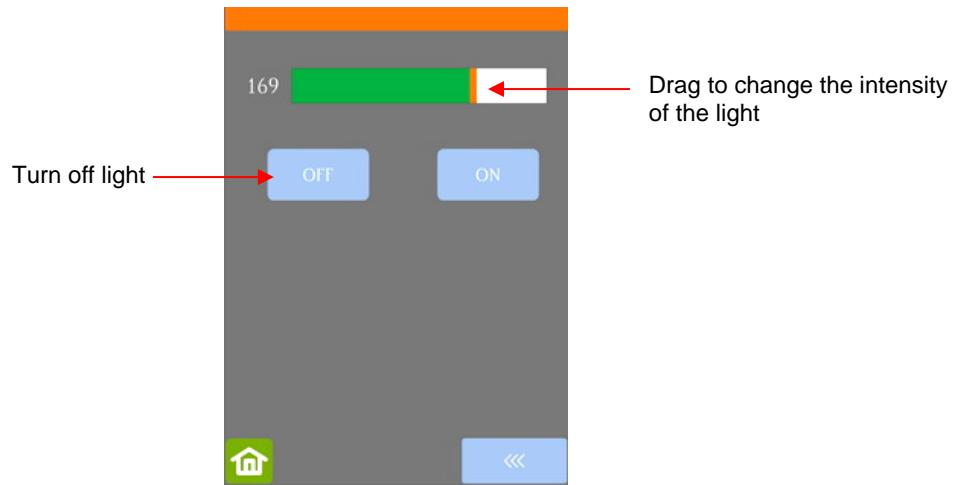

- **Screen and alarm** has two settings:

- ◇ **Screensaver time:** Set a black-out time, in minutes, for the control panel
- ◇ **Alarm after finish working:** When a job is complete, have an alarm sound (five beeps)

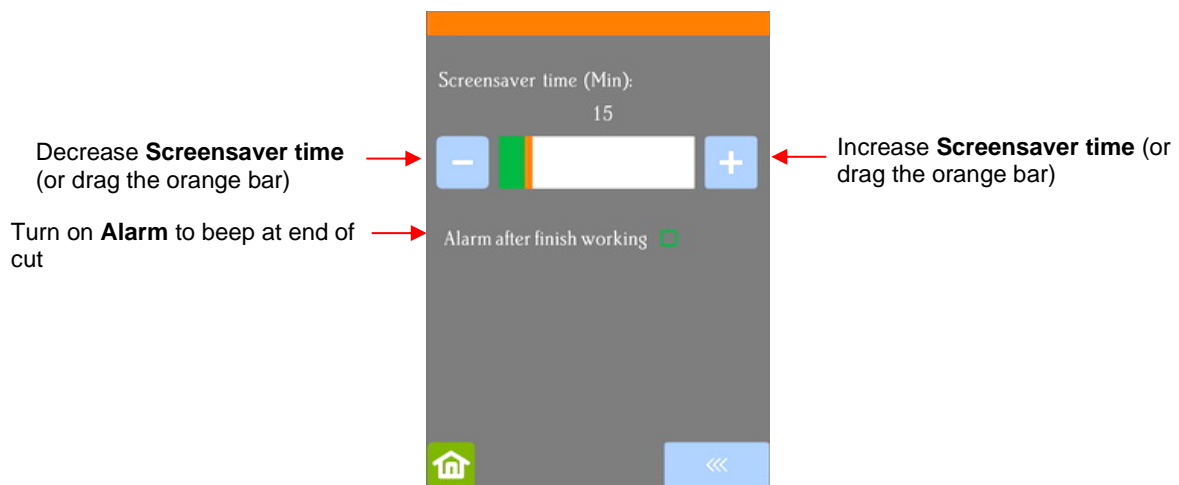

- **Unit** allows you to choose either inches or mm for settings such as **Show Point** and the **Spacing** setting under **Array**.

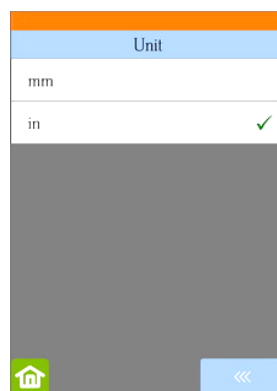

- **Language** allows you to choose from eight languages to be used throughout the control panel display screens:



1.14.3 Sys Information

- The **Sys Information** screen displays information about the Skycut and only has three setting changes available:



- ◇ This initial screen displays current version numbers.
- ◇ If you ever need to reset your Skycut, press and hold **Default All** until it turns red. Then wait for the button to update to **Success!**
- ◇ If you ever need to change which software is in use with your Skycut, press and hold **SOFT** for two seconds and release. The following screen will open:

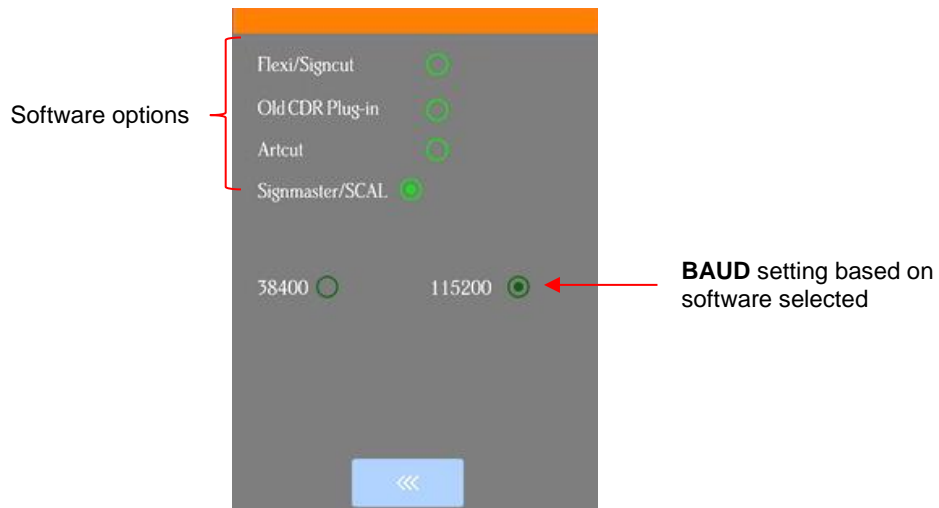

- ◇ To use a different software program to cut to the Skycut, press inside the appropriate circle. The **Baud Rate** indicator will automatically change if needed. Note: There is no longer a difference between the **Flexi/Signcut** option and the **Signmaster/SCAL** option, thus no need to change when using SignCut Pro.

1.15 Maintenance

Skycut machines do not require any kind of lubrication or routine checks. However, here are a few things to keep in mind for successful operation of your cutter:

- Keep the pinch wheels clean. Depending on the adhesive being used on the cutting mat, it's possible for the pinch wheels to become sticky and pick up small pieces of cardstock or other material being cut. This can lead, in some cases, to the mat skewing or ruining materials during subsequent cuts. To clean the pinch wheels, use a lint-free cloth and an adhesive remover such as isopropyl alcohol or Un-Du to clean the pinch wheels thoroughly.
- Keep the grit shafts clean. Equally important as the pinch wheels, the grit shafts beneath the cutting mat should also be free of adhesive and tiny bits of material. They can be cleaned the same way as the pinch wheels. Note: Do not pour cleaner onto a grit shaft. Instead, dab some adhesive remover onto a lint-free cloth and then use the damp cloth to clean the shafts. You can also use tweezers to remove any material or adhesive that is stuck to a shaft.
- Keep the cutting mat clean and sticky. As mentioned in the *Section 1.08.2*, the cutting mat can be washed with soap and water to remove small invisible pieces of material which are reducing the tackiness of the cutting mat. After drying, you can add more repositionable adhesive, if needed.
- Check your blade holder, as needed. If suddenly you cannot get a clean cut, check the blade holder for any tiny slivers of material that may have been caught up by the blade and fed up inside the blade holder.
- If you cut vinyl or other backed materials regularly, you may need to replace the cutting strip at some point. You will be able to tell based on seeing deep cuts in the strip and an inconsistency in the cutting. Contact your dealer for information on obtaining a replacement.

1.16 Other Useful Tools and Supplies

- The following list has items you may or may not need while enjoying your Skycut. These are suggestions based on twelve years of collecting information from other cutter owners:
 - ◇ Brayer or Rolling Pin: (1) to apply lint from a towel onto an overly sticky mat (2) to press materials evenly onto a mat for cutting
 - ◇ Post-It Notes: (1) for setting blade/tool tip height above a material (2) for draw and cut applications
 - ◇ Old Fluffy Bath Towel: (1) to dry a washed mat (2) to apply an invisible layer of lint onto an overly-sticky mat
 - ◇ Dishwashing Soap: (1) to remove visible and invisible fibers from the mat, thus renewing the adhesive (2) to clean the mat well before adding more adhesive
 - ◇ Soft Brush: (1) to gently remove waste scraps during the washing of a mat. Refer to *Section 1.08.2*.
 - ◇ Artist Palette Knife: (1) to gently remove cut shapes from a mat (2) to scrape off small waste pieces from a mat
 - ◇ Blue Painter's Tape: (1) to tape around the edges of thicker materials that might slip during cutting
 - ◇ Repositionable Adhesives: (1) to add more adhesive to a cutting mat (most any brand or type can be used, provided it is repositionable). Refer to *Section 1.08.2* for suggestions and instructions.
 - ◇ Adhesive Removers: (1) to completely strip a cutting mat of adhesive (2) to disarm adhesive long enough to remove large scraps of material that will not peel off
 - ◇ Lint-free Cloth: (1) for dusting off your cutter and cleaning pinch wheels and grit shafts

- ◇ Awl or Paper Piercer (or other sharp pointed tool): (1) to pick or lift out a test cut to verify results
- ◇ Stabilizers: A stabilizer is an adhesive material that is applied to the bottom of the material you are cutting so that cleaner cuts can be achieved. The stabilizer works in one or more of the following ways – (1) provides firmer contact with the cutting mat (2) provides a final layer that does not need to be cut if the stabilizer will be removed after cutting (3) prevent some slightly-elastic materials from being stretched by the blade. Recommended stabilizers include freezer paper, Thermo-web Heat n' Bond, and Steam-a-Seam 2.
- ◇ Double-sided Tape: (1) For securing metal tags or charms to the cutting mat for engraving
- ◇ Non-slip Shelf Liner: (1) To place under cardstock and other material when embossing

2. Cutting

2.00 Quick Reference for this Chapter

- How to *properly* mount the blade holder: *Section 2.01.3*
- How to control which shapes get cut: *Section 2.02.1*
- How to control where shapes get cut: *Section 2.02.2*
- Understanding **Blade Offset** and **Overcut**: *Section 2.03.3* and *Section 2.03.4*
- How to set a very precise origin: *Section 2.05.1*
- How to add weeding lines to a cut: *Section 2.06.3*
- Checklist before cutting: *Section 2.07*
- How to get shapes to cut to precise dimensions: *Section 2.08*
- How to know which settings to adjust to solve cutting issues: *Section 2.09*

The Most Common New Owner Mistakes:

- Too much blade is exposed on the blade holder (material is lifting up and/or tearing) - refer back to *Section 1.07.3*
- The blade holder or test pen haven't been properly mounted - refer to *Section 2.01.3*
- The pinch wheels are not properly positioned (material or mat is sliding around or bunching up during the cut) – refer back to *Section 1.09*
- Failing to do a test cut (recommended cut settings are not working) – refer to *Section 2.01.5* and *2.09*
- Not practicing enough with the test pen and paper (shapes are not cutting in the correct locations) – refer to *Section 2.02.2*

2.01 What You Need to Understand About Cutting

IMPORTANT: Please read all of 2.01!!!

2.01.1 You Have To Make Mistakes

- The key to becoming successful at cutting is to do a lot of it. Those who shy away from using their Skycut will never get to the stage of mastering it. It's very normal for new owners to be intimidated by their cutter, so remember the following key things:
 - ◇ You won't break your new Skycut by cutting paper, vinyl, cardstock, and other easy-to-cut materials. The worst thing that might *possibly* happen is that you'll break a blade. That's it! And the likelihood of even that happening is low.
 - ◇ You need to start cutting so that you'll begin making mistakes! It's in making these mistakes that you start to learn. You realize that these mistakes didn't result in a broken cutter. Plus, you'll stop making the same mistakes as you remember more of the things you need to check before every cut.
 - ◇ As you make fewer mistakes you begin to build confidence and you begin to have more cutting success. From there, you begin to experiment more and produce more. Thus, your best course of action is to just start cutting... a lot! But first, read the rest of this chapter.

2.01.2 Record Your Successes

- As you have successful cuts, take note of the settings you just used, such as **Force**, **Speed**, blade type, number of passes, brand of material, etc. There is a blank form in *Section 2.10* that you can print and use to record your results. There are also suggested settings for common materials at the end of this chapter. Use these as starting guides but remember that your results may vary based on the many factors which can affect cutting.

2.01.3 Installing the Blade Holder, Test Pen, or Accessory Tools

- The gold blade holder has a rim around the outside that will, when cutting most materials, rest on the silver part of the blade holder seat. When inserting the blade holder, loosen the front screw and then grasp the top and the bottom of the black piece and move back a bit while inserting the blade holder. The blade holder should then drop down so that the rim is below the black top piece of the blade holder seat:

Rim of blade holder is resting on the silver part of the blade holder seat

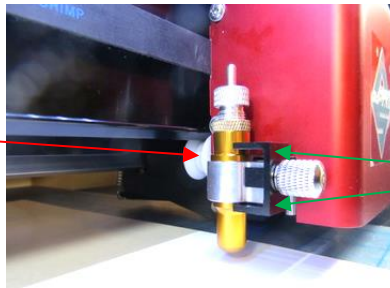

With the front screw loose, the black piece can be moved back just a little bit to allow the blade holder to drop down.

- The **Blade Height** is the distance from the tip of the blade to the top of the material you are about to cut. Thus, in the photo above, you can see that there are several millimeters of **Blade Height** which is important for two reasons:
 - ◇ You do not want the blade dragging across the material when the blade holder is moving from the origin to the first shape to cut (or between shapes).
 - ◇ More force is applied when there is a drop distance for the blade holder to start cutting. This is also referred to as “punch room” and provides more consistent cutting across the width of the machine.
- When cutting a very thick material, such as 2 mm craft foam, it is recommended that the rim on the blade holder be resting on top of the black piece:

IMPORTANT: Only install this way when cutting very thick materials!

Rim of blade holder is resting on the black part of the blade holder seat

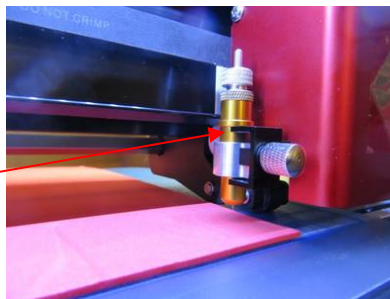

- When using the test pen or an accessory tool without a rim, you'll need to insert the tool using a spacer on top of the material. A stack of 35 Post-It notes or 35 sheets of regular copy paper work well.
 - ◇ The recommended method for loading the test pen or another accessory:
 - Place the spacer on top of the material, with the material loaded into the Skycut.
 - Loosen the screw on the blade holder seat and insert the tool so that the tip of the tool is touching the top of the spacer:

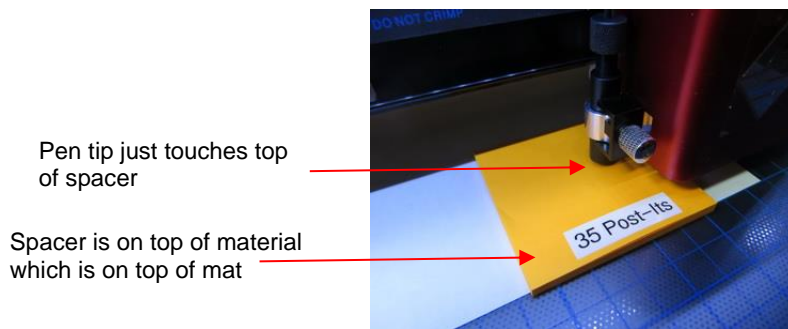

- Now tighten the front screw carefully making sure you are NOT pushing down on the blade holder seat. Once tight, remove the spacer. You should feel the tool gently scratching the top of the spacer.
- This distance will provide the tool some “punch room” to give extra force and more consistent results.

2.01.4 Adjust the Speed, Force, and Number of Passes Based on the Material and Shapes

- Using correct cut settings is equally important as the type of blade, blade length, and blade height. Refer to *Section 2.03* for details about each setting.

2.01.5 Perform Test Cuts!

- You have two options:
 - (1) Perform the built-in test cut on the Skycut itself using the **Test** option on the **Main Screen** or from within the **Speed/Force Screen**.
 - (2) Select any basic shape and size it to be around 0.3” – 0.5” (~ 8 mm – 13 mm):
 - Use the same instructions from *Section 1.13.3* to add a basic shape for cutting.
 - When cutting intricate shapes, use a small letter or a shape with lots of sharp turns for testing. For a rhinestone project, use a small portion of your rhinestone pattern as a test.
- There is a flow chart in *Section 2.09* which will help you determine which settings to change when test cutting a material.

2.01.6 Keep the Cutting Mat Clean and Sticky

- Press your materials evenly to the mat. Consider using a brayer both before AND after cutting. Repressing the material after cutting can greatly aid in weeding the cut shapes from the waste.
- When necessary, tape thicker materials to the mat to keep them from slipping during the cut.
- If you cut a range of materials, you might need more than one mat so that you can use stickier mats for certain materials.
- Refer back to *Section 1.08* for information on cleaning the cutting mat and adding more adhesive,

2.01.7 Don't Get Frustrated, Get Help!

- Besides having your own Skycut dealer as your first line of contact, there are other resources where you can ask questions and get answers. Utilize the resources listed in *Section 1.01*.

2.02 Choices Before Cutting

- There are a number of factors under your control for cutting:
 - ◇ What shapes to send to the cutter: *Section 2.02.1*
 - ◇ Where the shapes will be cut from the material: *Section 2.02.2*
 - ◇ What tool(s) will be used for cutting (or drawing, scoring, engraving, etc.): *Section 2.02.3*
 - ◇ What settings will be used: *Section 2.02.4*

2.02.1 Controlling Which Shapes Will Cut

- For this tutorial, the following shapes were created and then imported into SignCut Pro:

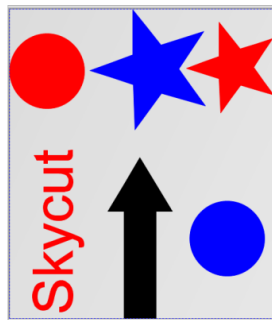

- In the upper right-side corner of the SignCut Pro screen, is the **Color Toolbar** with the following options:

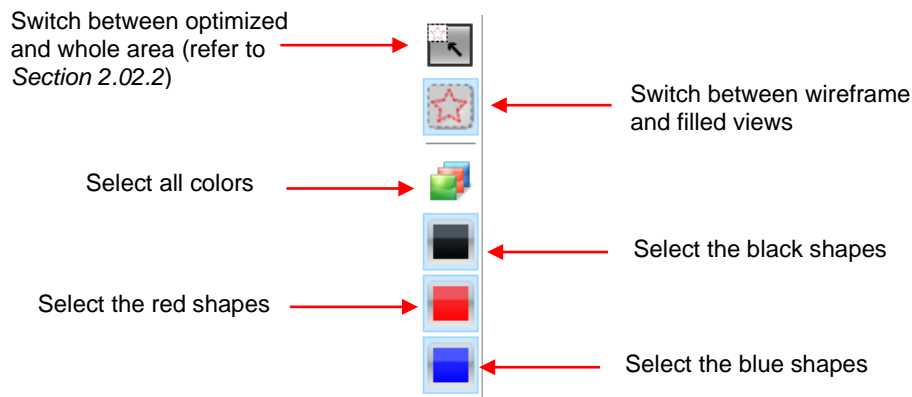

- Depending on your preference, you can display shapes in either wireframe or filled mode. Choosing one or the other does not affect the outcome of the cutting. It is for display only:

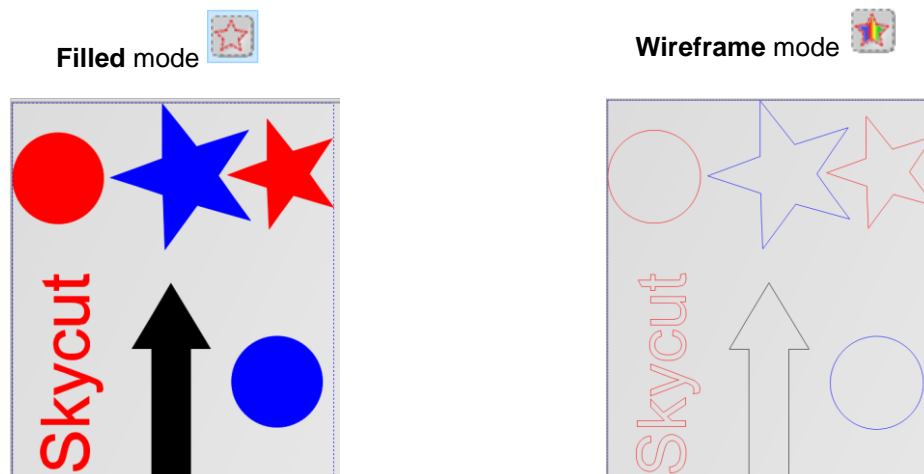

- There are several methods of selecting which color shapes to send to the cutter:

◇ Option 1: If all shapes are showing, then all shapes will be sent to cut:

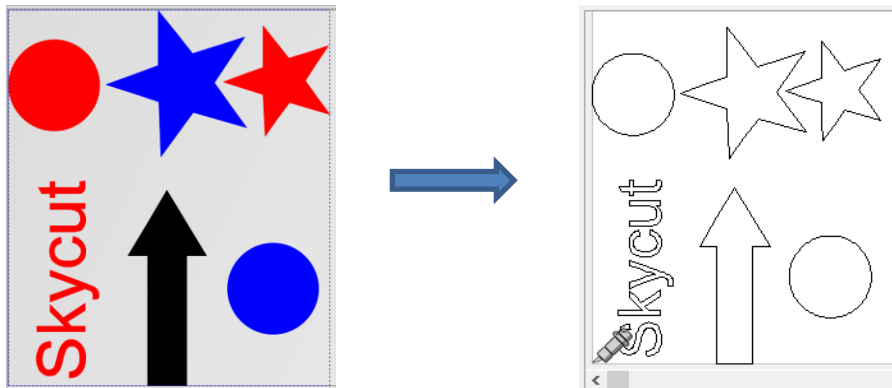

◇ Option 2: Click on any color thumbnail and only those shapes will be displayed. Those will be sent to cut. In this example, only the red thumbnail was selected:

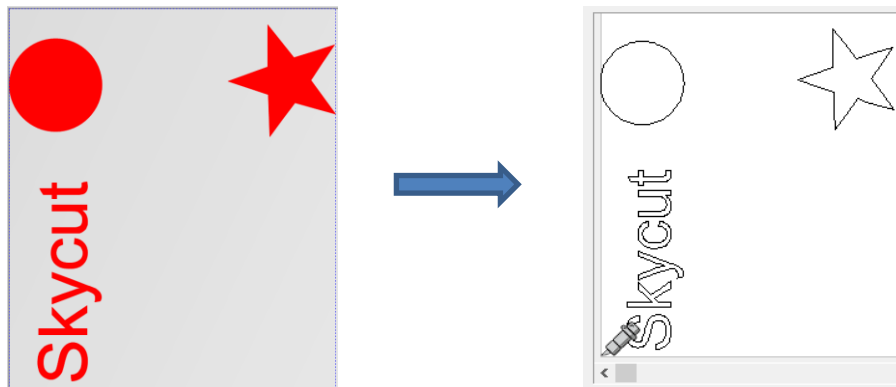

◇ Option 3: Click on any color thumbnail and, while holding the **Shift** key, click on one or more thumbnails of another color. The shapes in those colors will be displayed and they will be sent to the cutter. In this case the red and the black thumbnails were selected:

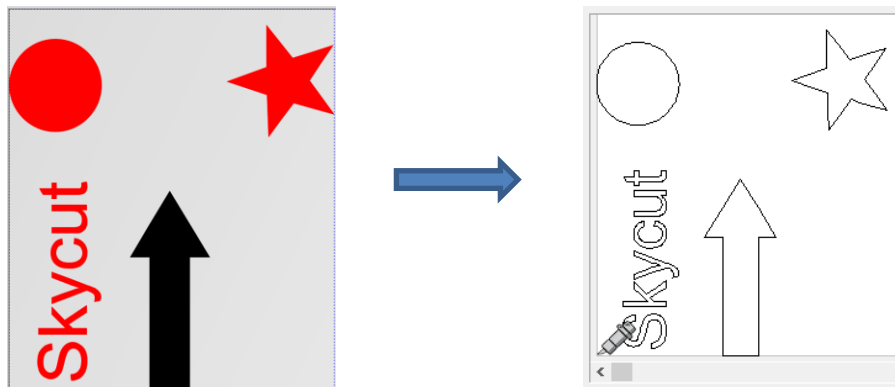

◇ Option 4: Hold the **Shift** key and click on any color thumbnail and it will be removed from the display. In this case, the **Shift** key was held and the red thumbnail was clicked, leaving blue and black displayed:

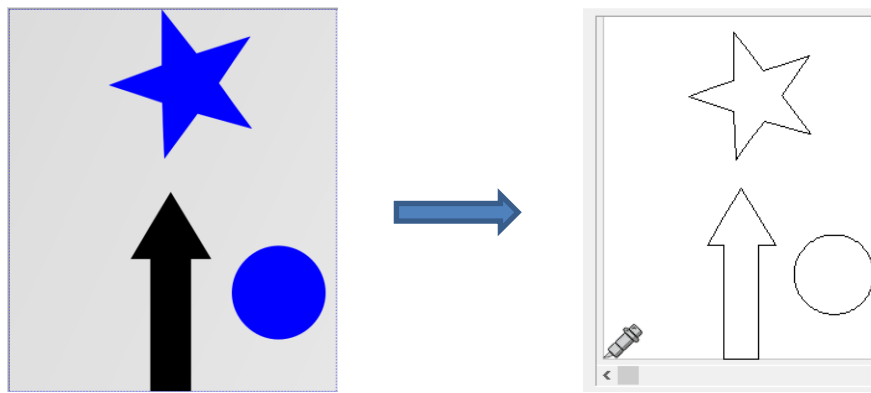





◇ Option 5: Instead of selecting by color, you can also mark individual shapes to be cut, excluding others that are still displayed:

- Click on the **Tools for objects** icon  on the left side **Main Panel**. In the **Sub-toolbar** at the bottom of the screen, the following icons appear:

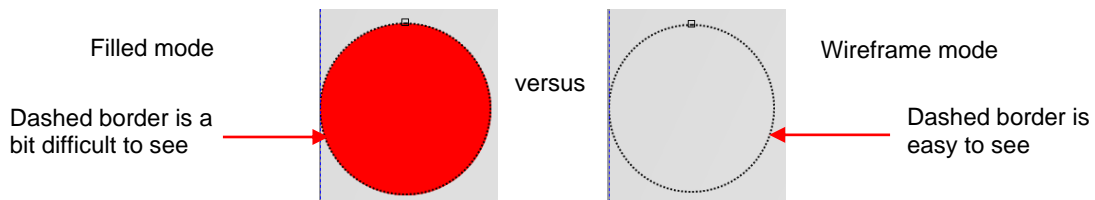



- **Marking tool**  : with this icon selected, you can click on a shape to select it. If you need more than one shape selected, hold the **Shift** key while clicking on additional shapes. The border on a selected shape will become a thin black dashed line. If you have difficulty discerning the dashed line, switch to wireframe mode:

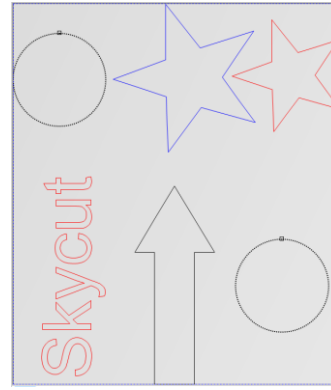
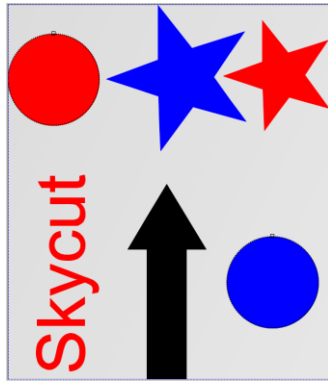

- **Switch between all / none**  : Toggle between having all shapes selected or none selected
- **Switch between marked / not marked**  : Invert the selection (any selected shapes will become unselected and vice-versa)
- **Change color of selected objects**  : Opens a color palette window where a different color can be selected
- **Setup path(s) attributes**  : Use this window to change various cut settings (refer to *Section 2.02.3*)

- With the **Marking tool** icon highlighted, select the shape(s) that you want to cut. In this example, the red circle and the blue circle will be selected. Wireframe mode is also shown:



- Click on the **Cut out** icon  and, in the preview window, these two selected shapes are the only two present for cutting and have been arranged to optimize material usage:

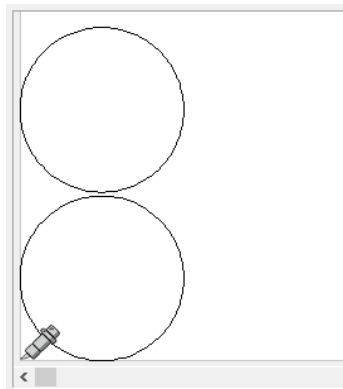

2.02.2 Controlling Where Shapes Will Cut

- The top icon on the **Color toolbar** is a setting which switches between **Whole area** and **Optimized**. Using the same shapes from *Section 2.02.1*, assume that only the blue shapes have been selected to cut:

- ◇ **Whole area** : shapes will be cut from the material as if the other shapes were still present:

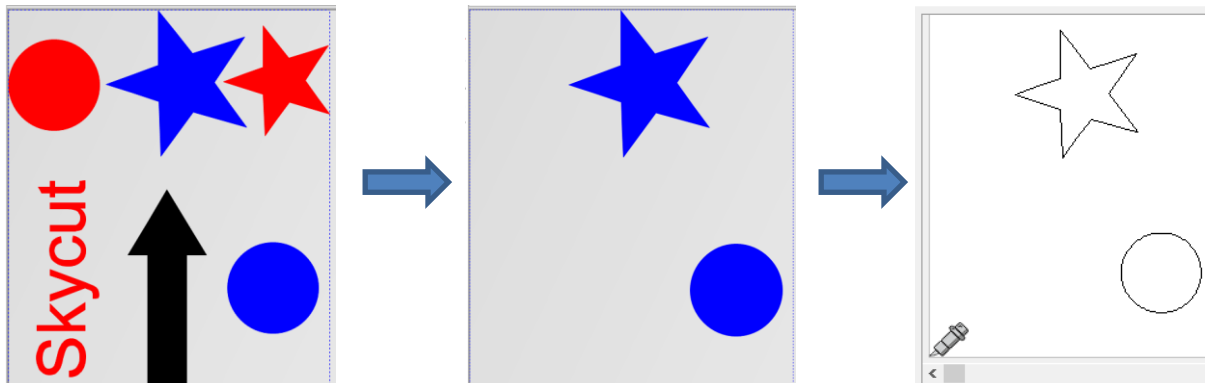

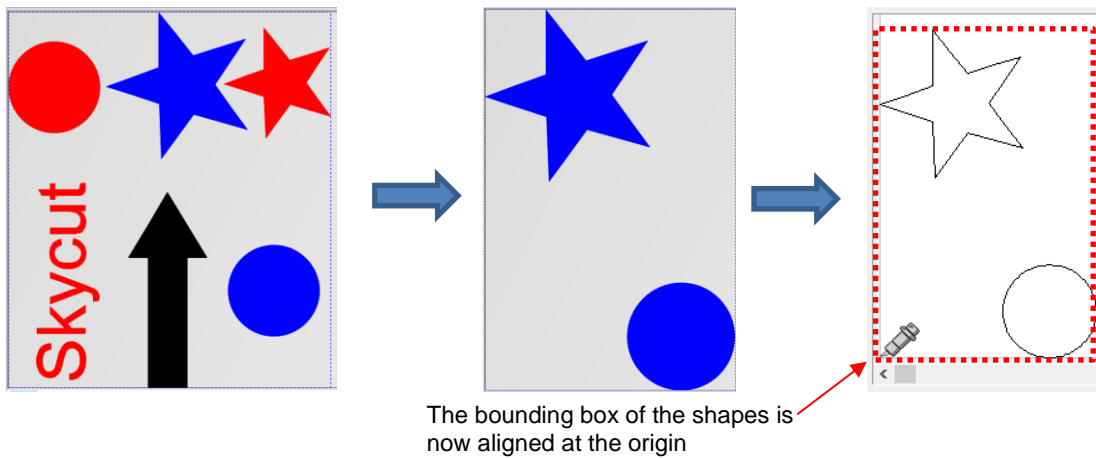

- ◇ **Optimized** : shapes will be moved and cut in alignment with the origin set on the cutter:



- In what applications is one mode preferable over another?
 - ◇ Use **Whole area** mode when it matters where shapes are cut from the material:
 - Two tool applications, such as when scoring with a scoring tool, followed by cutting with the blade holder
 - When engraving on existing objects, such as trophy labels or charms
 - When cutting from a specific location, such as the center of a piece of material
 - ◇ Use **Optimized** mode when it doesn't matter where shapes are cut. Since the shapes are moved to cut at the origin, it typically wastes less material.

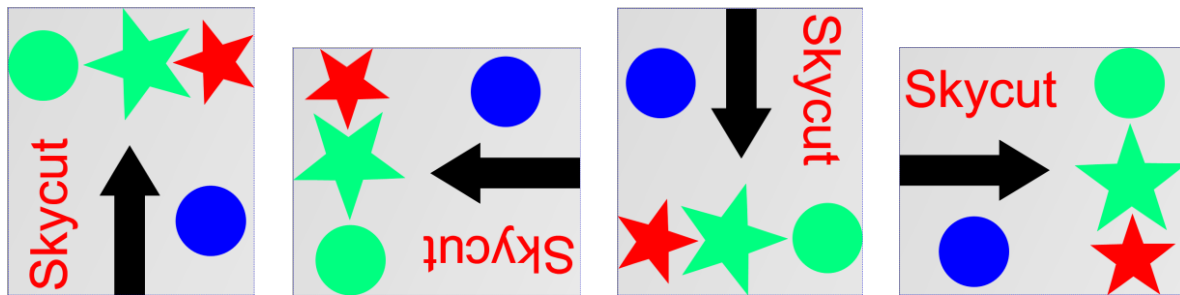

- You can also rotate a design before cutting by clicking on the **Rotate image in 90 degree steps** icon  at the bottom of the screen when in normal mode. Note that the **Tab** key is a handy shortcut for this function. Each click will rotate once counter-clockwise, allowing you a choice of four orientations:



- Two other rotation options at the bottom of the screen:
 - ◇ **Rotation for minimum vinyl consumption** : This function determines the best of the 4 possible rotations that will use the least amount of material.
 - ◇ **Reset the Rotation** : This function returns the shapes to the original rotation, however note that if you have elected to have files rotated upon being imported (under **Settings>Settings>Default Folder**), this setting will return it to how the shapes were positioned in the original file.

2.02.3 Where to Enter Cut Settings

- There are four locations where **Cut Settings** can be accessed in SignCut Pro (although not all offer the same settings):
 - ◇ Select the **Cut Out** icon  on the **Main Panel**, then the **Tool settings** tab (as was shown in *Section 1.13*)

- ◇ Select the **Cut Out** icon  on the **Main Panel**, then the **Advanced settings** tab
- ◇ Right click on any of the color thumbnails on the **Color Toolbar**
- ◇ Select the **Tools for objects** icon  on the **Main Panel**, select any or all of the shapes, then select the **Setup path(s) attributes** icon  on the **Sub-toolbar**

• **Cut Out > Tool settings tab**

- ◇ The settings entered in this window will be used for all shapes assuming:
 - You check the box labeled **Use software force and speed parameters** (Otherwise, regardless of what force and speed settings are used in the other windows, the **Force** and **Speed** setting on Skycut's control panel will be used.
 - You haven't entered specific settings by color or by selected shapes (as will be covered in the subsequent options)
- ◇ Thus, this is the best option to use when the same settings are used for all shapes in the project:

Check this box if you want force and speed sent from the software versus on the control panel → Use software force and speed parameters

Save setting: refer to *Section 2.04* → 

Choose **Force** and **Speed**: refer to *Sections 2.03.1* and *2.03.2* → Cutting force: 45 g (1 - 160); Cutting speed: 8 cm/s (1 - 13)

Dashed line cutting options: refer to *Section 2.03.6* → Override default pouncing values; Pounce down length: 0"; Pounce up length: 0"

Change cut direction option: Switch direction on open paths:

Multi-cut settings: refer to *Section 2.03.5* → Passes: 1; Passes, registration marks: 1



Blade offset settings: refer to *Section 2.03.3* → Blade Offset: 0.0161"; Overcut: 0.0259"

Tool selection menu → Tool: Tool 1

• **Cutout > Advanced settings tab**

- ◇ With this option, different cut settings can be assigned based on color. This works well in projects where some paths need to be cut as dashed lines (also called pouncing) or in multiple-tool projects, such as score and cut.
- ◇ At the bottom of the **Advanced settings** window, a list of each color used in the project will appear with the following options:

Mark this option to change cut order by color → Cut in colour order

Colour(s)	RGB	Settings
	# 0 0 0	Preset: Test Pen Drawing
	# 0 0 FF	Force: 30 Speed: 5 Num laps: 1 Tool: 0
	# FF 0 0	Force: 60 Speed: 8 Num laps: 2 Tool: 0

Colors active in project

Current settings assigned to shapes of each color

Open **Edit attributes** window → ↑ ↓ → Move a selected color up or down in the list

- ◇ **Cut in colour order:** Marking this option will no longer cut shapes with respect to location in the project. Instead, all shapes of the top color in the menu will be cut before cutting shapes of the next color and so on down the list.
- ◇ If using the **Cut in colour order** option, the order in which the colors are cut can be changed using the up and down arrows below the menu of colors. First, click on a color from the menu and then move its cut order as desired.
- ◇ To the right of each color are the current **Force, Speed, Passes,** and **Tool** assigned to that color. Note there are additional settings that can be made. To make changes, click on a color and then click on the **Edit attributes** button below it. The follow window will open:

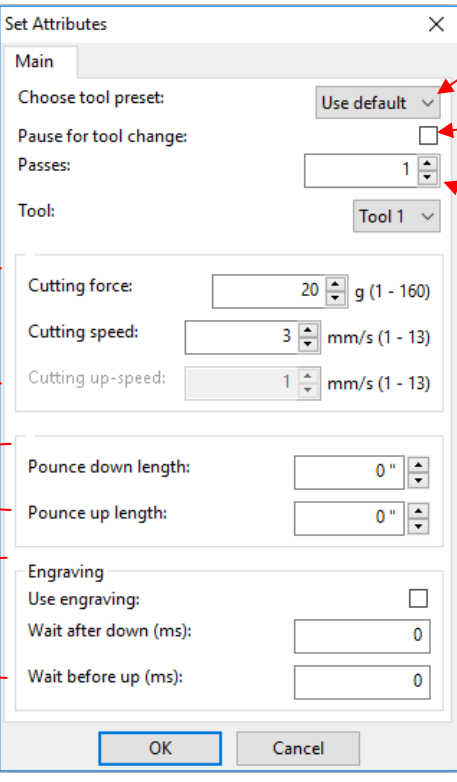

Select a **Preset**, if set up

Mark this option if a tool change is needed before executing this scolor

Number of **Passes**

Enter **Force and Speed**

Enter **Pounce** (dashed line) settings (refer to *Section 2.03.6*)

Rotary engraving settings (not applicable to Skycut use)

OK Cancel

• **Color Toolbar**

- ◇ Use this option instead of the **Advanced settings** tab to assign cut settings to each color:



- First, left click on a color thumbnail on the **Color Toolbar** to select the shapes of that color and hide those of other colors. If another color will share the same cut settings, then hold the **Shift** key and left click on that color (or more, as appropriate).
- Right click on any of the selected thumbnails and the same **Set Attributes** window will open where settings can be entered.
- These new settings will then match those assigned by color in the **Advanced settings** tab.

- **Tools for objects > Setup path(s) attributes**

- ◇ Use this option if you want to select particular shapes and temporarily override the current cut settings assigned to those shapes based on their color.
- ◇ Use the instruction in *Option 5 of Section 2.02.1* to select the shapes you wish to cut. In this case the same two circles as presented in that section will be selected:

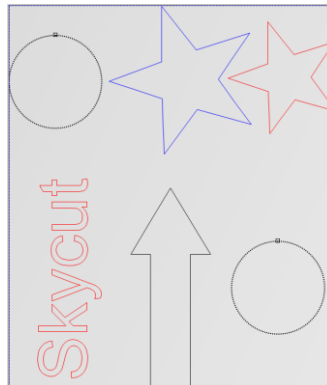

- ◇ Click on the **Setup path(s) attributes** icon  on that **Sub-toolbar** . The same **Set Attributes** window opens and new settings can be entered.
- ◇ Go to the **Cut out** window and, again as shown in *Option 5 of Section 2.02.1*, the shapes are moved to the origin and nested.

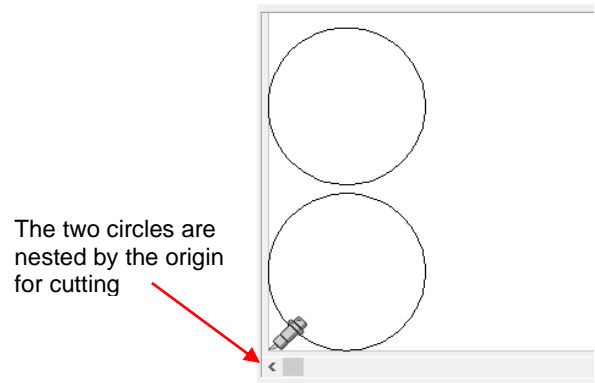
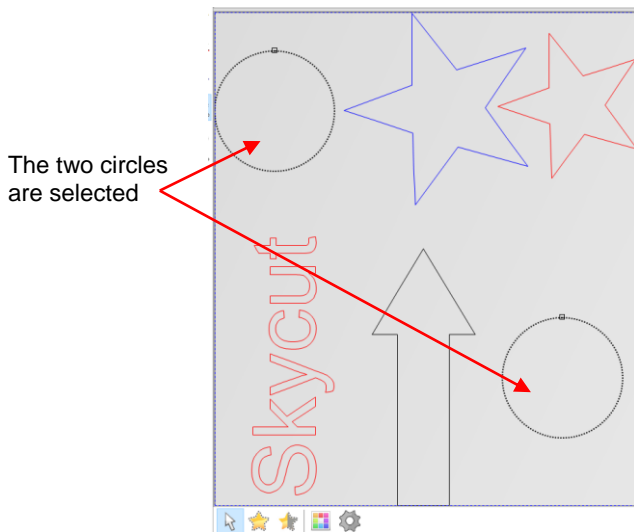

- ◇ After cutting, the settings for these shapes will return to those assigned to their respective colors.
- ◇ Depending on the application, having the shapes automatically nest and cut at the origin may not be what you need. Thus, one solution would be to change their color to something not already used in the project. After selecting the shape(s), choose the **Change color of selected objects** icon . Then use the **Color toolbar** option to change the cut settings for that color.
- **Final note:** Remember that when using any of these cut setting windows, the option for **Use software force and speed parameters** must be checked on the **Tool settings** tab in the **Cut out** window.

2.03 Cut Settings

2.03.1 Force

- **Force** (also called **Pressure**) ranges from 30 to 160 where the maximum of 160 represents ~2000g of cutting force. If it is set too low, the material cannot be cut. In fact, it is recommended that the minimum setting is always 30 or higher. However, if it is set too high, you will get bad cutting (even incomplete cutting at times) and tearing of the material. Always perform small test cuts before cutting your actual project and make adjustments in order to get a clean test cut before proceeding with your larger cut.
- Dull blades will need more force than new blades, thus anticipate increasing the force over the life of the blade.
- When cutting materials that can use either blade, the 45° blade (red cap) will need a little more force than the 60° blade (blue cap), because of the extra contact with the material being cut and because the 60° blade is cut much thinner, making it a “sliver blade.”
- As noted earlier, this setting can be made on the Skycut control panel instead. Press the **Force/Speed** icon  and then set the **FORCE** to the desired level.

2.03.2 Cut Speed and Up Speed

- **Cut Speed** (also called **Down Speed**) is how fast the blade travels while it is in the “down” or cutting position. **Up Speed** (also called **Travel Speed**) is how fast the blade travels while in the “up” position, such as when it is moving from the origin to the location of the first shape to cut or when moving from one cut shape to begin cutting another.
- The Skycut has 13 speed settings ranging from “snail’s pace slow” to “insanely fast.”

- ◇ The settings from 1 through 4 are the slow speeds and should be used when cutting dense difficult materials, such as chipboard, craft plastic, styrene, and balsa.
- ◇ The settings from 5 through 8 are medium speeds and should be used for easy-to-cut materials, such as cardstock, vinyl, iron-on transfer, and rhinestone template material.
- ◇ The settings from 9 through 12 are the fast speeds and are useful for engraving, embossing, and drawing. You may, however, find that some materials will cut well at the faster speeds.
- **Cut Speed** is usually more important to control since the blade may need more contact time with a particular material. **Up Speed** can usually be left quite high although, for print and cut accuracy, it may need to be lowered if there are many shapes to be cut from a printout.
- Currently, SignCut Pro does not have the option to send **Up Speed** from the software. Thus, if you need a separate **Cut Speed** and **Up Speed**, please use the control panel for this setting.
- On the Skycut control panel, the default setting is to have the **Up Speed** and **Cut Speed** the same and referred to as **SPEED**. This can be adjusted by pressing the **Force/Speed** icon  and then setting the **SPEED** to the desired level. In order to enter a separate **Up Speed** on the control panel, refer to *Section 1.14.1*.

2.03.3 Blade Offset

- **Blade Offset** is the horizontal distance from the center of the blade shaft to the tip of the blade. A pen or engraving tool has an offset of 0 because the tip is centered with the center of the pen/engraving tool shaft. But a blade is different:



- If you set the **Blade Offset** to 0 when cutting with a blade, corners will be rounded. On the other hand, if it is set too high, bubbles will be cut on sharp corners:

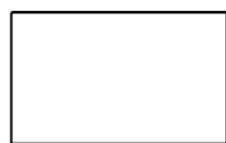

Offset is too low:
corners are rounded



Offset is too high: bubbles
appear at the corners

- Below are the approximate **Blade Offset** settings to use for each of the three types of Skycut blades:
 - ◇ Red capped blade: 0.3 mm
 - ◇ Blue capped blade: 0.4 mm
 - ◇ Blue capped reflective blade: 0.6 mm
 - ◇ Yellow capped blade: 0.75 mm
- Any time you order new blades, check for the recommended **Blade Offset** on the packaging. However, it's not unusual for blades to be slightly off-spec.

2.03.4 Overcut

- **Overcut** is related to **Blade Offset** in that it isn't needed when using a pen, embosser, engraver, and so forth, because the tips of those tools are aligned with the center of the tools themselves. However, leaving **Overcut** at 0 when using the blade holder will result in large shapes not quite closing:



Overcut is too low:
paths do not close

- In some cutting programs, **Overcut** is not a separate setting but rather automatically calculated and applied based on the **Blade Offset** entered. However, in SignCut Pro2, you can enter an actual **Overcut** setting and should do so any time a blade is used.
- In general, the blade type doesn't greatly affect the **Overcut** required. Try using 1.00 mm. In the event you cut a large closed shape, like an 8" circle, you may find that you'll need to increase **Overcut** to 2.00 mm.

2.03.5 Passes

- The **Passes** setting causes each individual path to be cut the set number of passes before the blade moves to the next path to cut. This is better than just repeating the entire cut as each repeated pass is cut with the blade held down throughout the repeated passes, resulting in cleaner cutting.
- Both the **Cut Out >Tool settings** tab and the **Set Attributes** window have a **Passes** option which can be marked and then the number of **Passes** set:

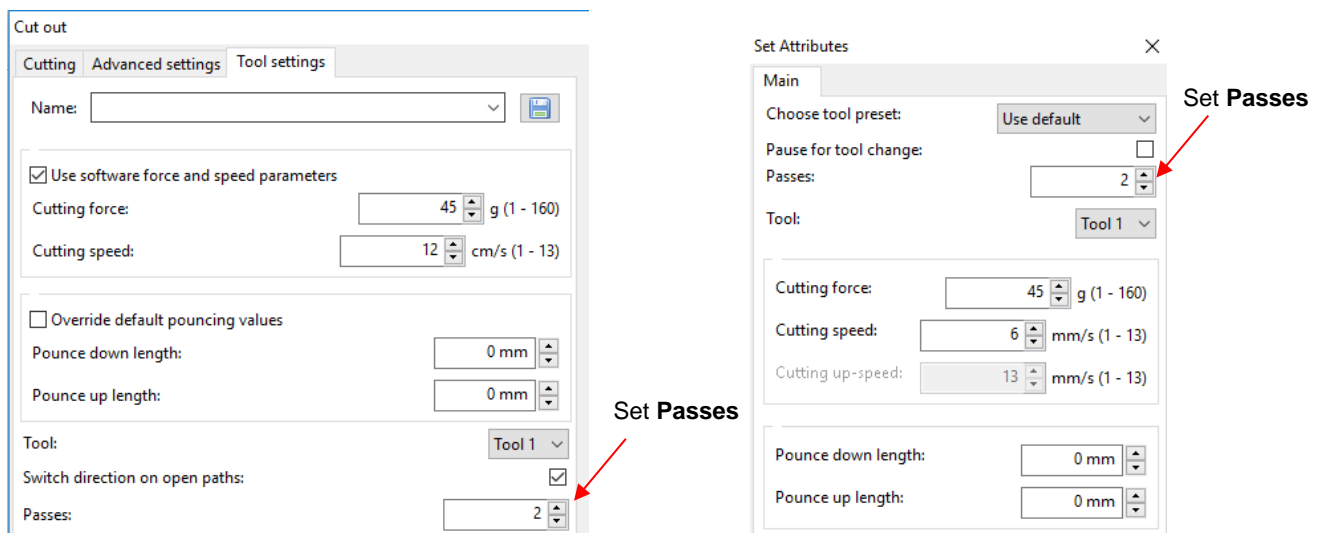

- **Passes** is recommended in the following situations:
 - ◇ Cutting thicker denser materials, such as chipboard, where multiple passes allow the blade to progressively "carve" through the material
 - ◇ Cutting certain fibrous materials, such as fabric, where a second pass will ensure that all of the fibers have been cleanly cut
 - ◇ Cutting intricate or detailed shapes (such as script titles) from certain materials, such as heavy or textured cardstock, where a single pass may leave certain spots not cleanly cut
 - ◇ Cutting rhinestone template material where a second pass results in much cleaner weeding of the cut circles

- **Passes** can also be set on the Skycut control panel when, for example, a cut is being made using a USB flash drive. However, unlike using **Passes** from SignCut Pro, the blade does not stay down to repeat the cut. The **Passes** function behaves like a repeat cut.
 - ◇ If you are only using the left side or only the right side, press the **USB** button on the **Main Screen** and you will see a **Passes** button in the window which opens:

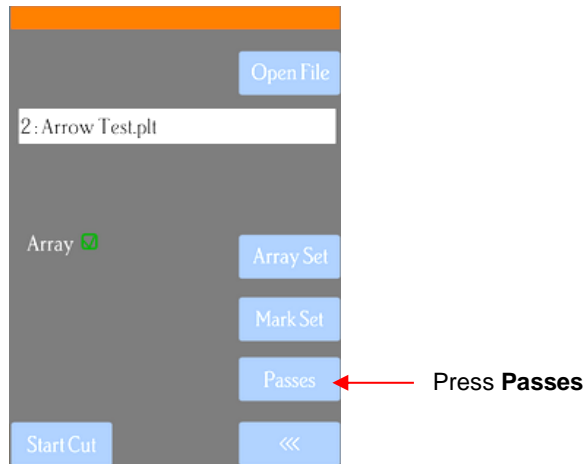

- ◇ Press the **Passes** button to open the following screen where you can turn on the **Passes** function and enter the desired number of repeats:

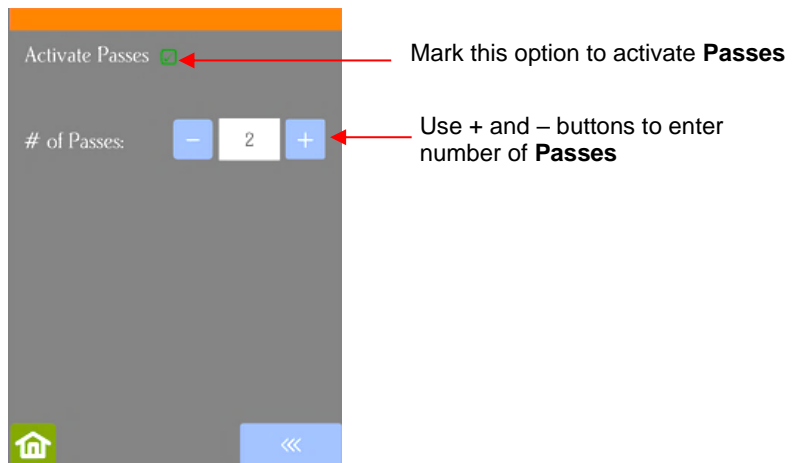

- If you are planning to use both heads, make sure **Use Double Head** is activated on the control panel's **Main Screen**. If you do not see this option (as shown in the following screenshot), click on **Set>Advanced settings>System mode** and select **double**. Then, back on the **Main Screen**, the following options should now appear:

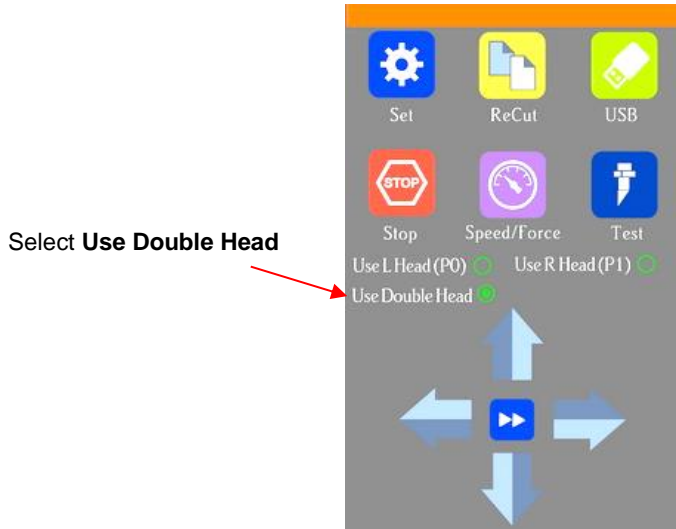

- ◇ Press the **USB** button on the **Main Screen** and you will see a **Passes** button in the window which opens:

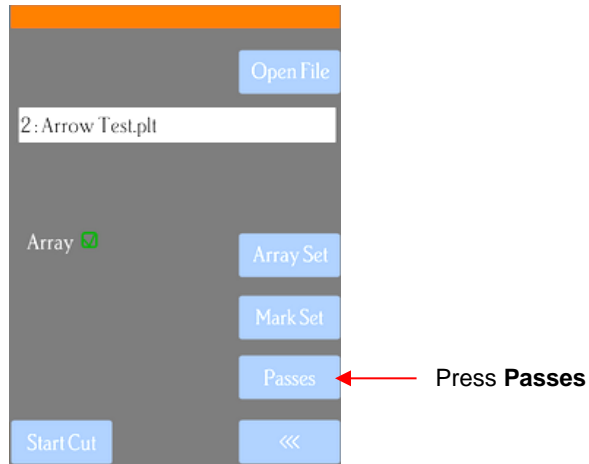

- ◇ Press the **Passes** button to open the following screen:

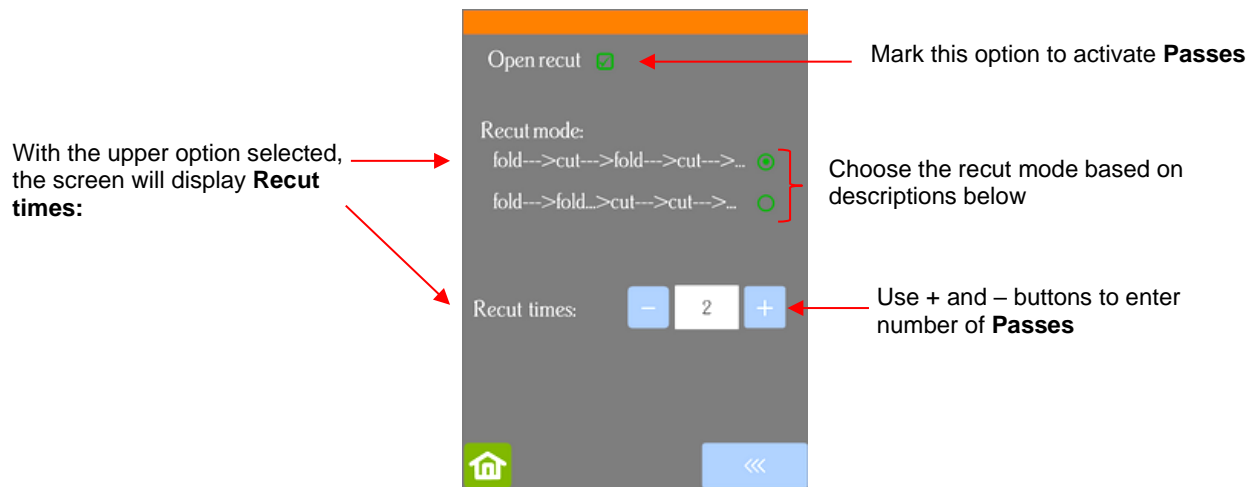

- Recut mode has two options:

- ◇ If the upper option is marked, then the screen shows a setting called **Recut times** which you set based on the number of passes you want both sides to perform (when doing dual head applications). Note that it will execute both sides' shapes before doing additional passes.

- ◇ If the lower option is marked, the screen changes and you can enter different passes for the two heads to perform. Note that it will execute the passes on one side before executing the passes on the other side:

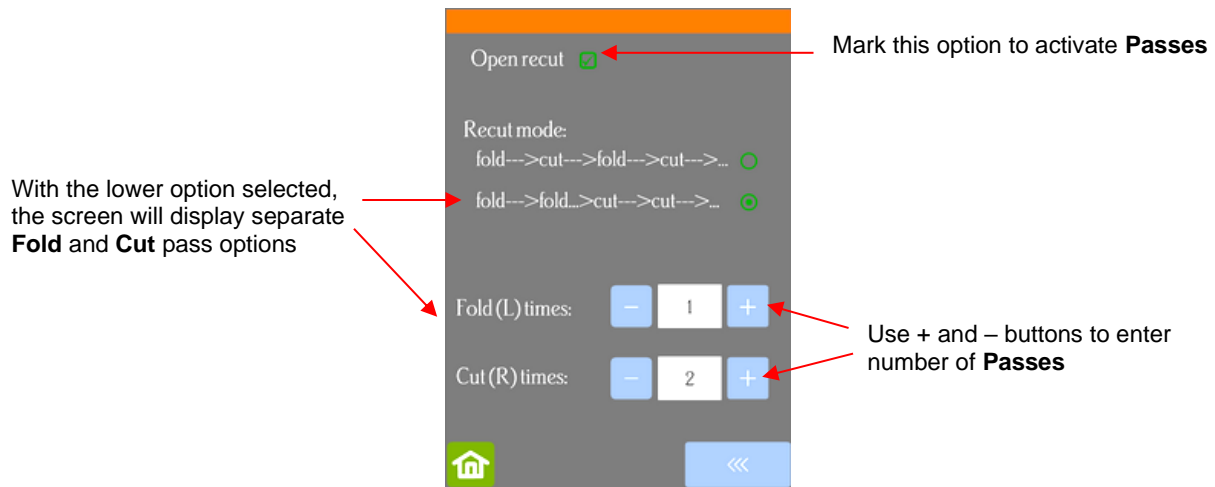

- **IMPORTANT:** Currently the **Open recut** option will default to off whenever the Skycut is first powered on. Thus, make a mental note (or, even better, put a Post-It note on your cutter) to turn this option on when using multiple passes in dual head operations.

2.03.6 Pounce (Dashed-line Cutting)

- If you have an application that needs dashed cut lines, **Pounce** settings can be made in both the **Cut Out > Tool settings** tab and in the **Set Attributes** window:

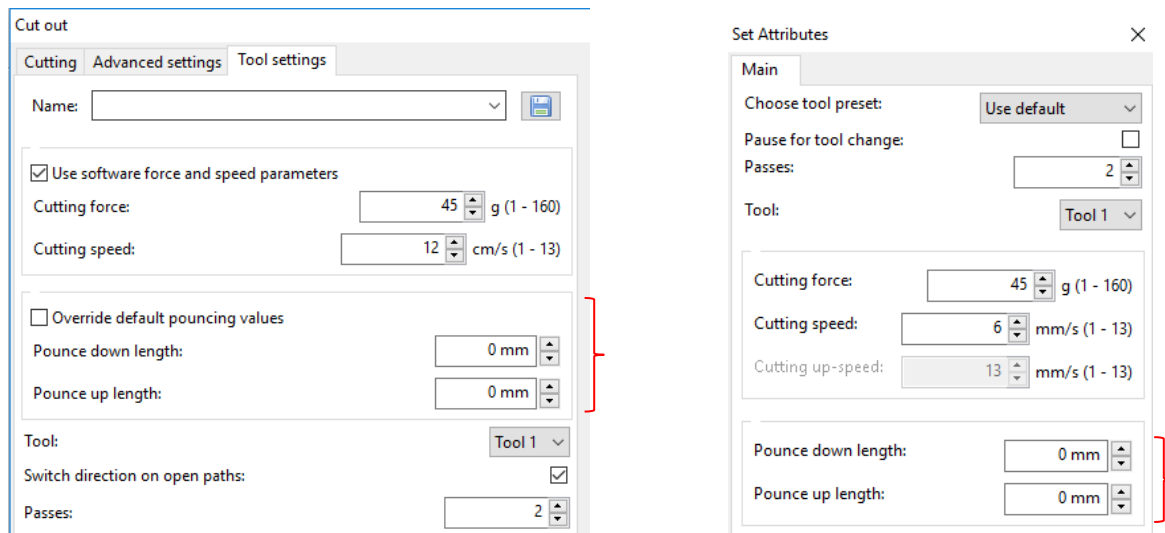

- Enter the values for the following settings:
 - ◇ **Pounce down length:** this is the length of the dashed cut
 - ◇ **Pounce up length:** this is the spacing between the dashed cut lines
 - ◇ If you are unsure about what to use, try 3 mm (0.12") for **Pounce down length** and 6 mm (0.24") for **Pounce up length** as a test. In general, you want the spacing to be larger than the dash, especially if the dashed cut will be folded and unfolded repeatedly.

2.04 Presets

- Presets allow you to save your settings for a particular material or application, such as cutting posterboard or scoring cardstock. A preset can be entered in SignCut Pro or saved on the Skycut control panel.

2.04.1 Saving a Preset in SignCut Pro

- Go to the **Cut out >Tool Settings** window and enter the settings for the material or application:

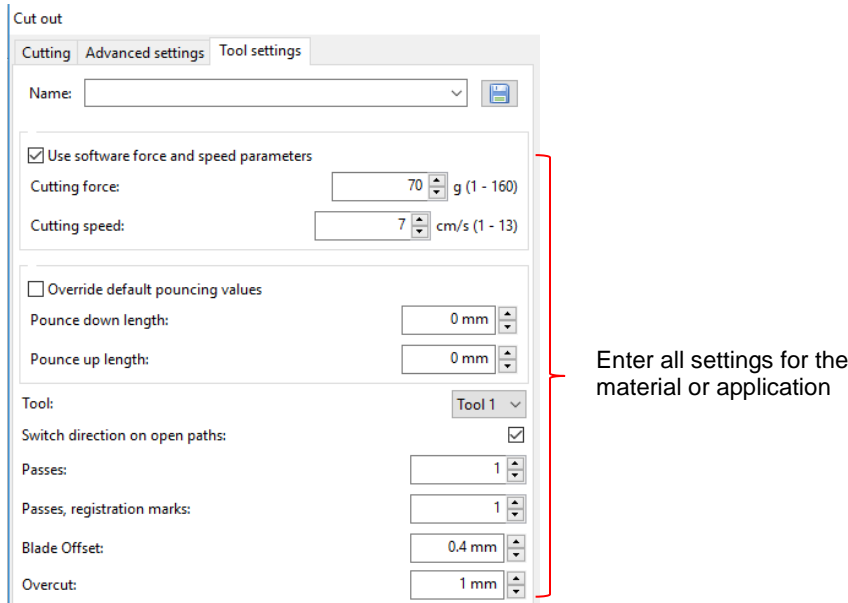

- At the top, enter the **Name** you wish to save the settings under. Then click on the **Save** icon:

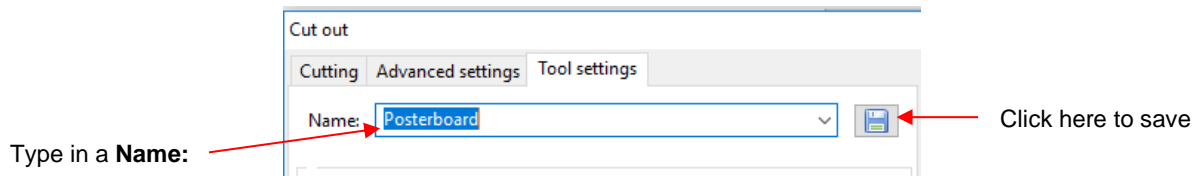

- This preset will now be available in the dropdown menu, both in this same window or from the **Set Attributes** window:

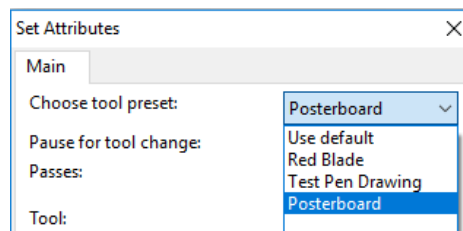

2.04.2 Saving a Preset for a Material

- **IMPORTANT:** As was noted in Section 2.02.4, **Up Speed** (aka **Travel Speed**) is not functional in SignCut Pro2 and both speed settings do not apply with **Tool 1** (right side) applications. Thus, unless using a preset with **Tool 0** (left side) cutting, it is recommended that presets be made on the control panel.
- Before proceeding, note the following:

- ◇ Even if you are not using the right side for a particular material, make sure the control panel is set to **Double** under **Set>Advanced Settings**. Otherwise any presets entered will be automatically assigned to the right side.
- ◇ Because settings for any given material or application would need to be entered twice to make those settings available for both right and left sides, consider which side you might always choose to use. For example, if you always use the left side for cutting and the right side for scoring, then only enter those settings for those sides.
- ◇ There's a maximum of 10 presets allowed, thus consider which materials or applications are most important to you.

- To create a preset:

- ◇ Verify that **Use Double Head** is selected on the main control panel screen:

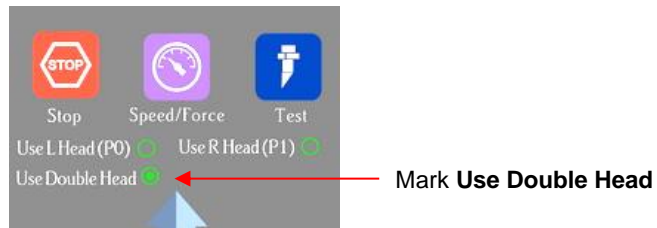

- ◇ Press the **Force/Speed** icon  to open the **Force/Speed** screen:

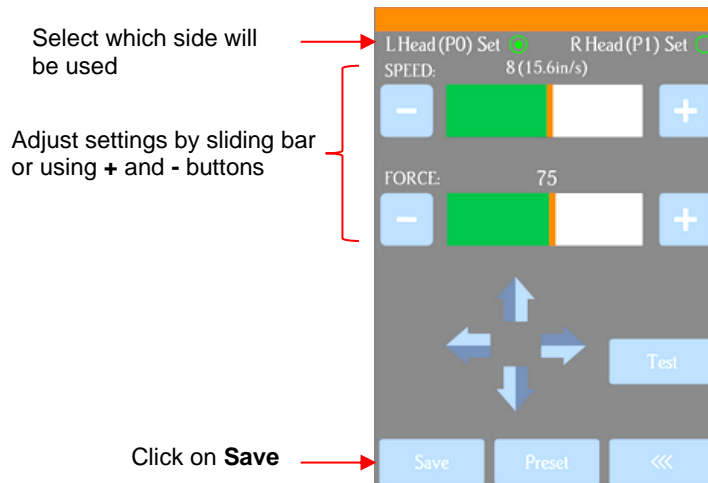

- ◇ Make the necessary changes to the **SPEED** and **FORCE** settings. Select **Save** and the following screen opens:

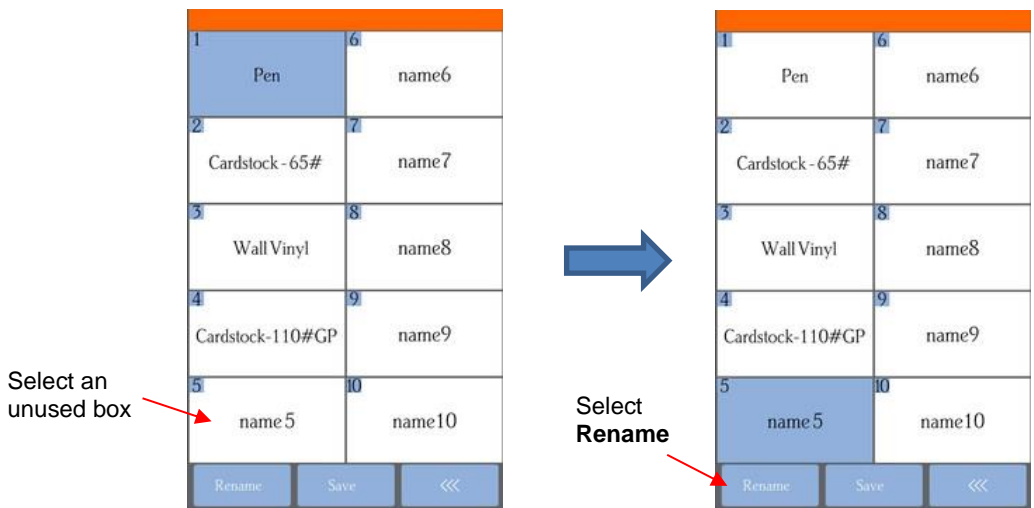

- ◇ Press one of the unused preset boxes, e.g. *name5*, and it will turn blue indicating it is highlighted. Select **Rename**.
- ◇ A window opens where you can enter the name for the new **Preset**. The characters are entered in the same manner as the **Password** entry window in *Section 1.12.2*. Note that there is a 15 character limit. Click on **OK** when done:

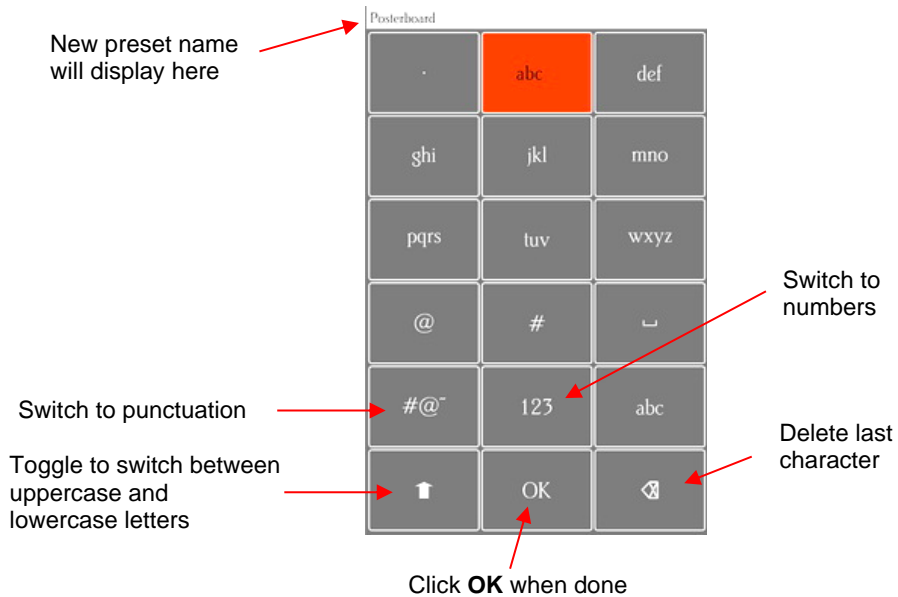

- ◇ You will now see the name of your new preset and you can press **Save** to add it to the saved presets with the **FORCE** and **SPEED** you set. You will be returned to the **Force/Speed** screen.

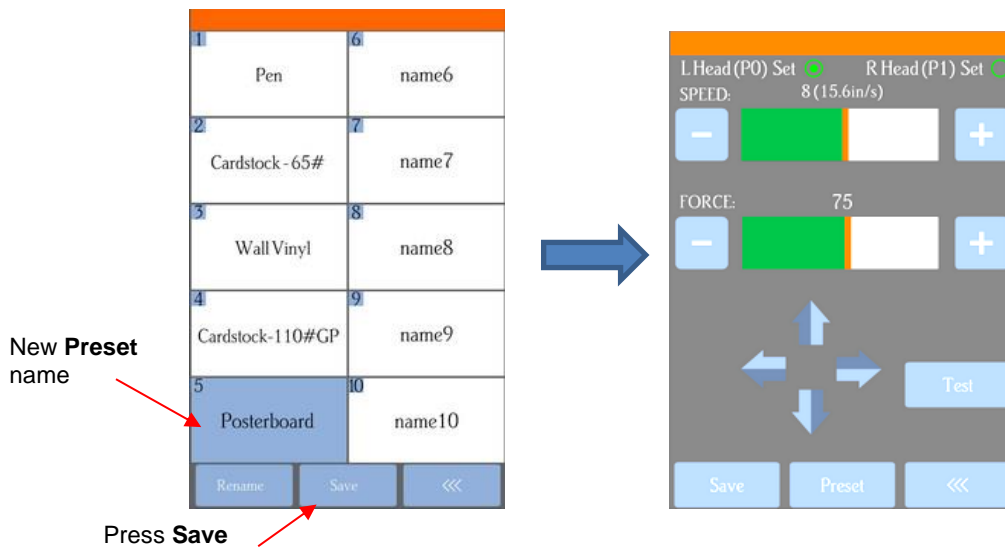

- ◇ To verify the preset or to select a different preset, press **Preset**. The **Preset** window opens where you can see all of the **Presets**, along with the settings for those presets. In that window you can also select a different preset. Then you can select **Rename** to edit its name or select **Load** to select that preset's **Force** and **Speed** into the **Force/Speed** screen. Note that if you need additional **Passes** when cutting a material, they will need to be set using the instructions from *Section 2.03.5*.

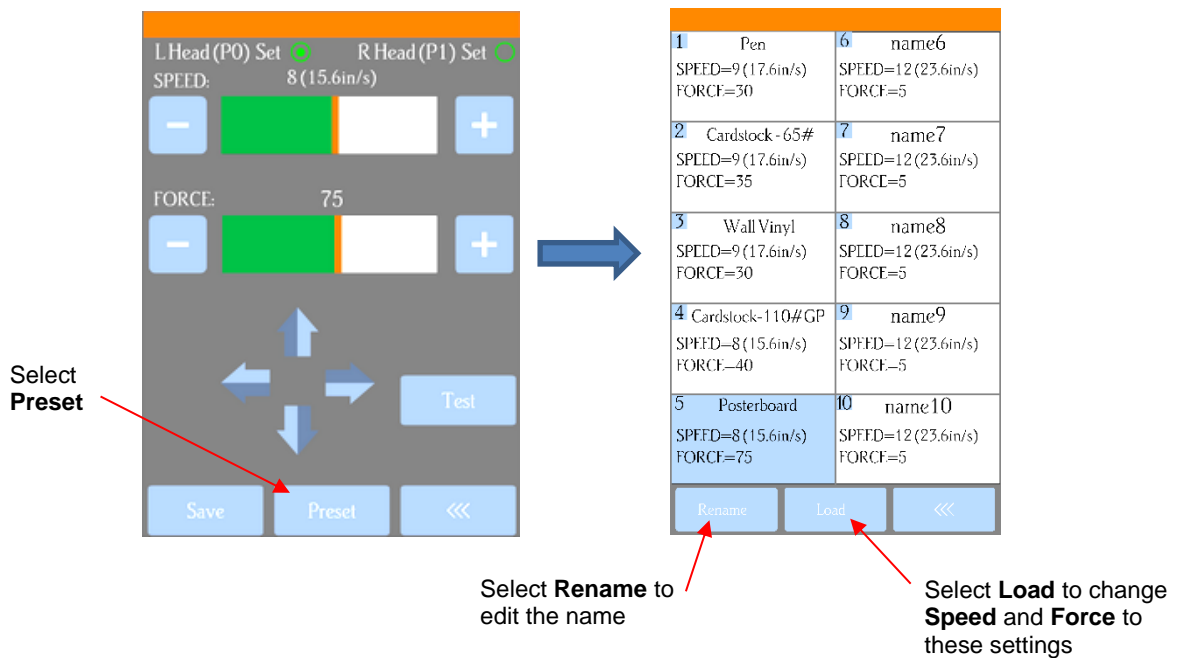

2.05 Setting the Origin before Cutting

- Before you cut, you should check to see where the blade tip is located in relation to the material so that the shapes will cut in the appropriate location.
- **IMPORTANT!** The Skycut D24 has a maximum cutting width of 24 inches. If you move the head too far to the left to begin the cut and your project is wide, you may exceed the left side limit and cutting will stop at that point with no option but to abort.
- To set the origin, press the arrow buttons on the main screen of the control panel. Remember that the middle button can be toggled between regular speed and a slow speed for more control:

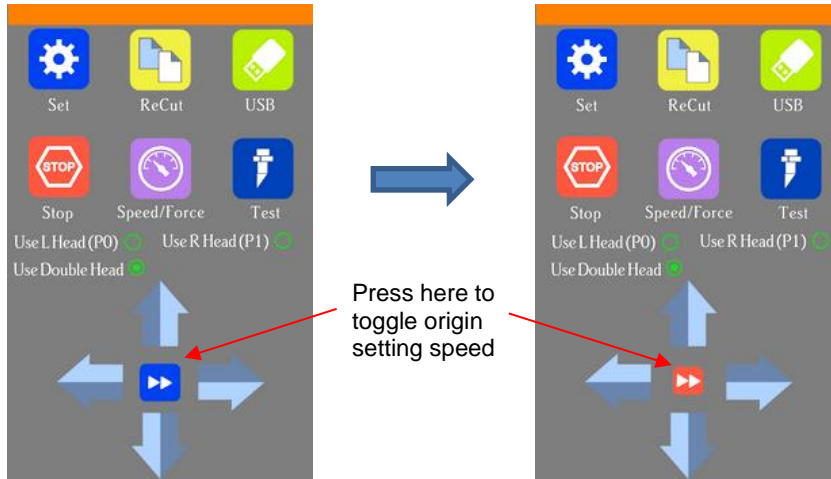

- In general, you set the origin near the lower right corner of the material, as you did during your initial test drawing in *Section 1.13*.
- If you ever choose to have **Use R (Head) (P1)** selected on the control panel, the origin will be base on the right-side tool, versus the normal left side:



2.05.1 Setting an Origin Using the Camera

- In the event you need to set an extremely precise origin, the Skycut’s built-in camera can be used:
 - (1) Go to *Section 3.03* and perform the camera calibration.
 - (2) Choose where you want the origin to be set. You’ll need an “origin target” to use when the camera takes a photo. It can be a dot on your material, the corner of your material, the intersection of grid lines on the mat, etc. If you do choose the latter, make sure there’s a way to clearly distinguish which intersection you want to use.
 - (3) On the Skycut’s **Main Screen**, use the arrows to move the center of the blade holder roughly over the origin target. In this example, a dot will be used.

- (4) Select **Set** and **Camera**. In the **Camera Screen**, press **OK**. A photo will be taken and displayed. If needed, press **X3** so that you are zoomed out and able to see the origin target (dot) in the photo:

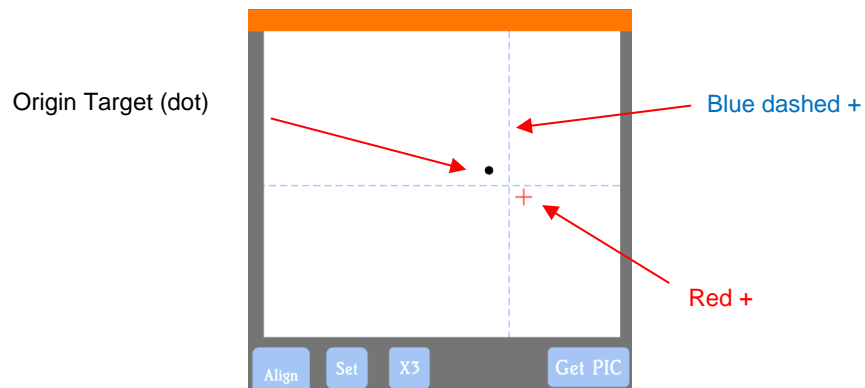

- (5) Press the center of the origin target in the photo so that the red + will be moved approximately over it:



- (6) Press **OK**. In the new photo, the blue dashed + should be close to the origin target. Press **X3** to zoom in:

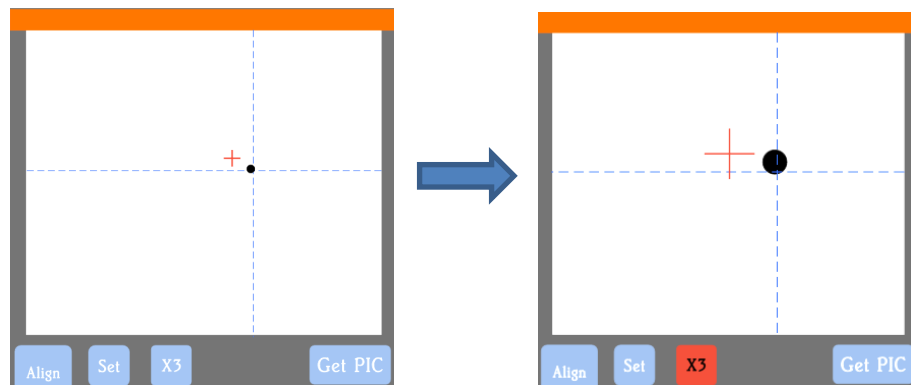

- (7) Use the arrow buttons to move the red + as close as possible to the center of the origin target:

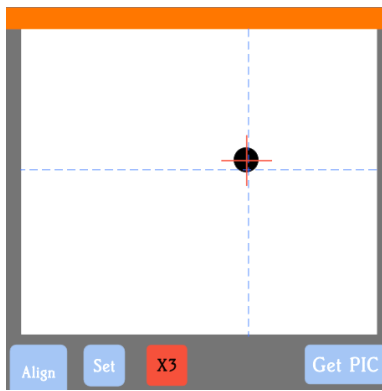

(8) Press **OK**. At this point the blue dashed + should be centered with the origin target:

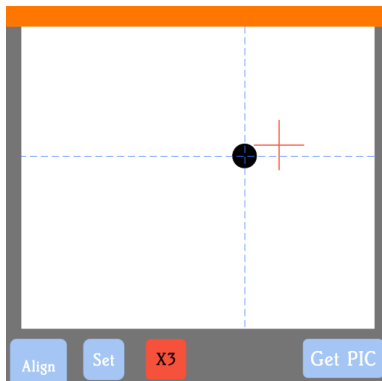

(9) Press the **Home** icon to return to the **Main Screen**. The head should move so that the blade holder is now located over the origin target and you can proceed with the cutting process.

2.06 Other Cut Setting Functions

- There are other functions and features available in SignCut Pro and on Skycut's control panel that will be useful depending on your applications. Some have already been covered. Some will be covered in this section. Others will be covered in later parts of this manual.

2.06.1 Advance Mode

- The **Advance After Plot** option in SignCut Pro2 Pro is actually controlled on the Skycut itself. The function can be opened by going to **Set>Advance Mode** on the control panel.

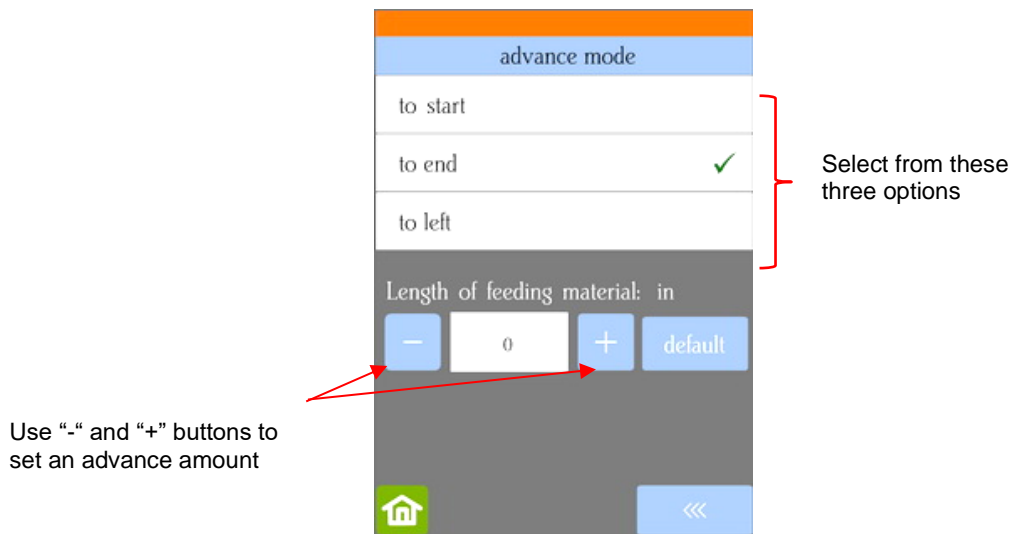

- ◇ **to start** will cause the blade holder to return to the origin after cutting.
- ◇ **to end** will cause the blade holder to advance forward to the end of the cut project.
- ◇ **to left** will cause the blade holder to move to the left of the cut project.
- ◇ The settings below the option are activated when choosing either **to end** or **to left**. You can enter a specific distance for the blade holder to advance. This is useful when cutting repeats of the same project because it allows for the origin to be set automatically for the next repeated cut.

2.06.2 Mirror

- Checking the **Mirror** option  on the **sub-toolbar** will apply a horizontal mirror to the shape (s) before cutting. This is useful in applications such as:
 - ◇ Cutting HTV in which the material is placed faced down so that the heat protection layer is not penetrated by the blade
 - ◇ Cutting vinyl to be applied to the inside of a car or home window but primarily viewed from outside of the window
 - ◇ When cutting certain non-homogenous paper materials in which cutting upside down yields cleaner results

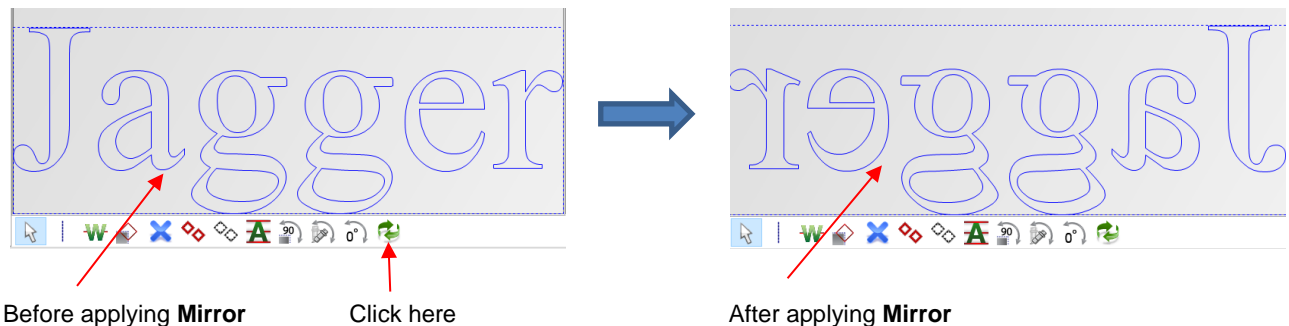

2.06.3 Weeding Line Tools

- For those cutting vinyl and HTV, the **Weeding line tools**  in SignCut Pro are very useful. Upon selecting the icon (or shortcut **T**), the sub-toolbar displays the following options:

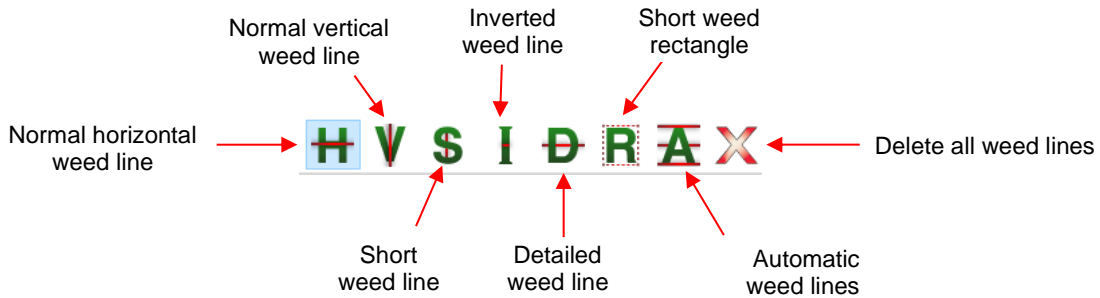

- Before covering each option, note the following:
 - ◇ For most of the functions, left clicking the mouse will add a weed line. Holding **Shift** and/or **Ctrl** will provide additional options.
 - ◇ Weed lines can be dragged, as needed.
 - ◇ To delete a weed line, hold the **Ctrl** key and right click on the line.
 - ◇ For projects that will be cut by color, each color can be individually selected on the **Color Toolbar** and the weed lines added for only that color.

- **Normal Horizontal Weed Line**  - Left click once where you want a horizontal weed line added:



- ◇ Hold the **Shift** key while clicking and instead of creating a horizontal line, a vertical weed line will be made. While there is a second option on the sub-toolbar for adding vertical weed lines, it can be more convenient to add them while in **Horizontal weed line** mode if you're needing both types of weed lines:



- ◇ Hold the **Ctrl** key and left click to add short weed lines inside any spaces you choose. For example, short lines were added in these three spots:

Hold the **Ctrl** key and left click to add short horizontal weed lines

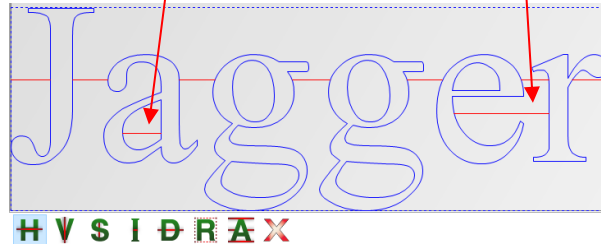

- ◇ Holding both the **Shift** key and the **Ctrl** key while clicking allows you to add short horizontal weed lines, as needed.

- **Normal Vertical Weed Line** **V** – Left click once where you want a vertical weed line added:



Click to add a vertical weed line

- ◇ Hold the **Shift** key while clicking and instead of creating a vertical line, a horizontal weed line will be made. Again, this can be more convenient to add them while in **Vertical weed line** mode if you're needing both types of weed lines:
- ◇ Hold the **Ctrl** key and left click to add short vertical weed lines inside any space you choose. For example, short lines were added in these three spots:

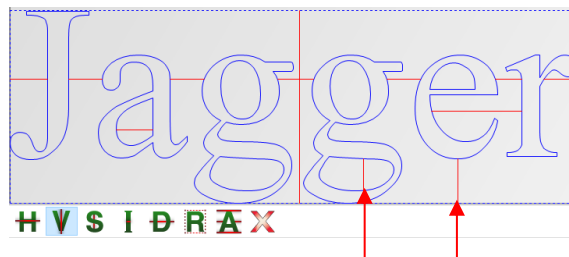

Hold the **Ctrl** key and left click to add short vertical weed lines

- ◇ Holding both the **Shift** key and the **Ctrl** key while clicking allows you to add short horizontal weed lines, as needed.

- **Short Weed Line** **S** - If you need to add a lot of short weed lines or, perhaps, only short weed lines, then this option will allow you to left click to add short lines without needing to hold the **Ctrl** key. Hold the **Shift** key to add short vertical weed lines:

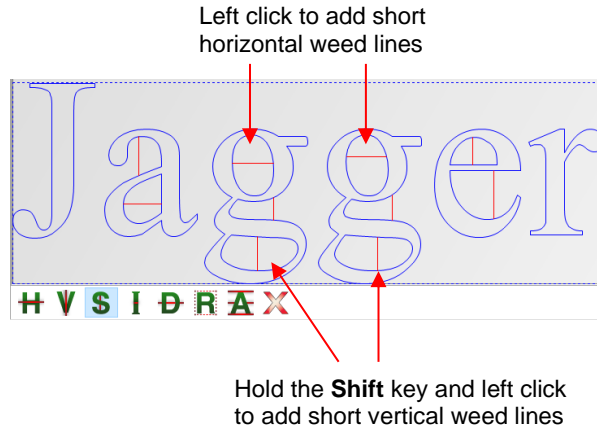

- **Inverted Weed Line I** - In some cases, such as stencil applications, the part being weeded is the opposite. Thus, what is normally the waste part of the material is the part being kept. Thus, in this example, it would be the letters themselves being weeded away, so having weed lines inside the letters would be desirable. Use the **Inverted Weed Line** tool to place weed lines inside the letters:

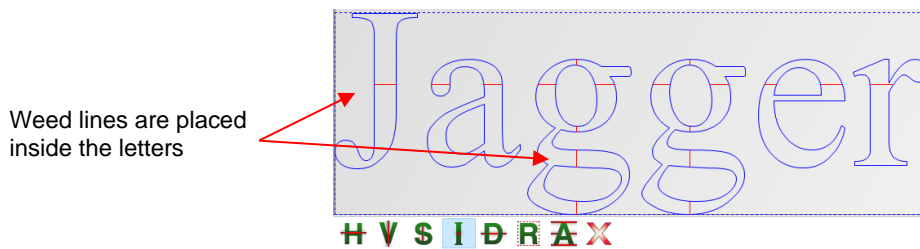

- **Detailed Weed Line D** - This option adds the weed line through any internal shapes as well as the normal waste area outside. Note the difference between the **Normal Horizontal Weed** and **Normal Vertical Weed** versus using the **Detailed Weed Line** option:

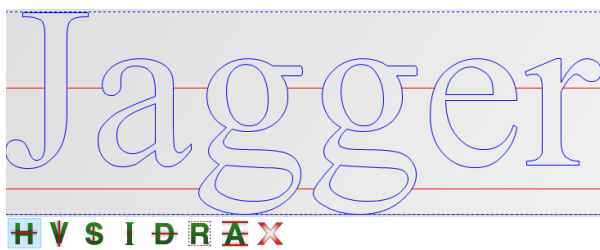

Normal horizontal weed option

versus

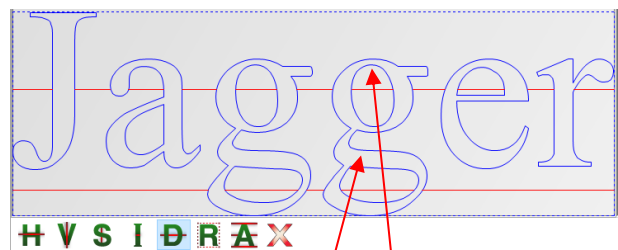

Detailed weed line option – weed lines pass through interior shapes, as well

- **Short Weed Rectangle R** - Drag the mouse to create a rectangle which is added as a weed, along with horizontal and vertical extended weed lines:



Drag mouse from here to here

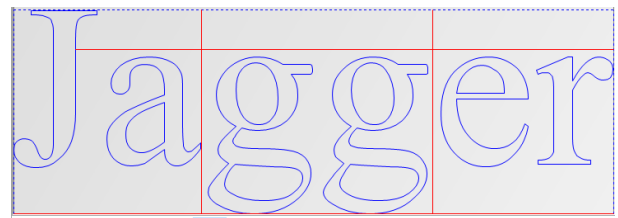

Rectangle is created with extending lines

- **Automatic Weed Lines**  - Automatically adds weed lines to the design. Left click to add horizontal lines and/or **Shift** + left click to add vertical lines:

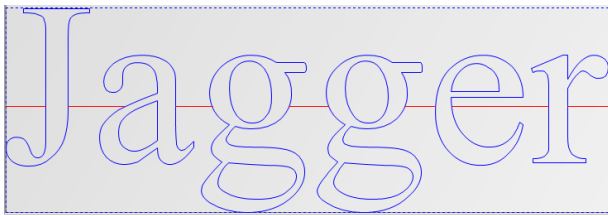

Left click here

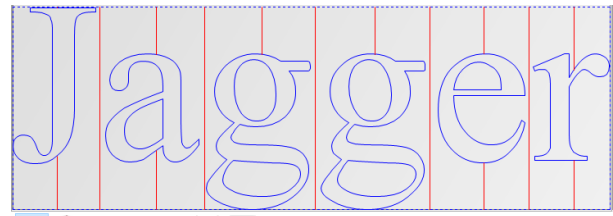

Shift + left click here

- ◊ Note that this option is also available on the sub-toolbar when in **Collection of commonly used tools** mode.

- **Delete All Weed Lines**  - Clicking this icon will delete all weed lines.

2.06.4 Tiling Options

When cutting projects that are larger than the maximum cutting width of the cutter or the available material, the project will require tiling. This involves dividing up the design into rectangles that will later be pieced together after cutting. SignCut Pro offers two ways to accomplish this: automatically by entering the dimensions of the desired tile size or manually by clicking to add tile lines to your project.

Automatically Creating Tiles

- The **Tiles Panel** above the **Work Area** contains the tools needed to automatically tile a project into individual tiles based on dimensions entered. In this example, a large tree design will be tiled for application using 12" wide wall vinyl:

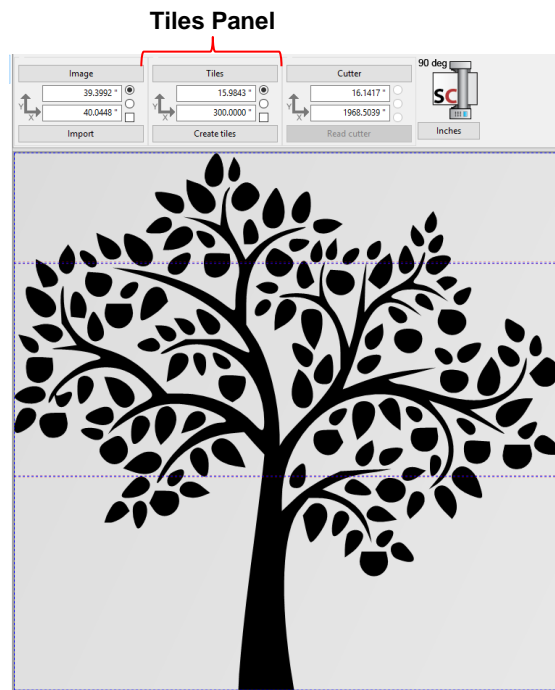

- In some cases, the limiting factor which leads to the need for tiling is the maximum cutting width of the cutter. In other cases, as presented here, the limiting factor is the width of the material available.
- Click on the **Tiles** button and the following window opens:

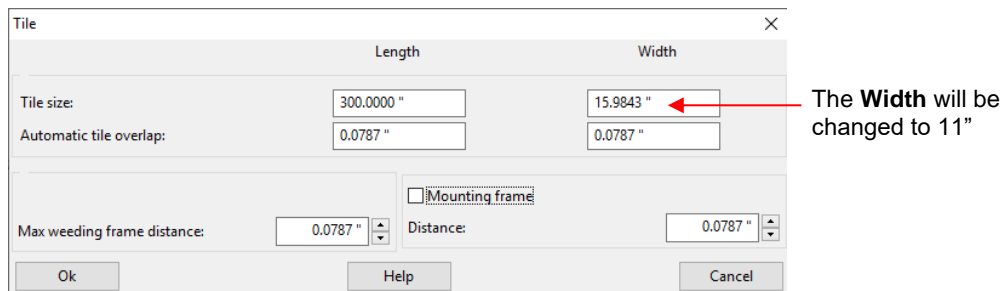

- ◇ **Tile size:** Enter the maximum **Length** and **Width** of each tile. Assuming the vinyl is on a roll, the **Length** can be left at a maximum size. The **Width**, however, will be changed to 11" because the wall vinyl happens to be 12" in width.
- ◇ **Automatic tile overlap:** mounting vinyl can be easier if a small amount of overlap is allowed. This ensures there will be no unsightly gaps in the final project after application.
- ◇ **Mounting frame:** mark this option to add a rectangle around the tiles. This can aid in alignment and/or weeding, as needed.
- After entering the **Tile Size Width** as 11 inches, click on **Ok** to close the window. Then click on **Create tiles** and the preview will update with the 11" tiles generated:

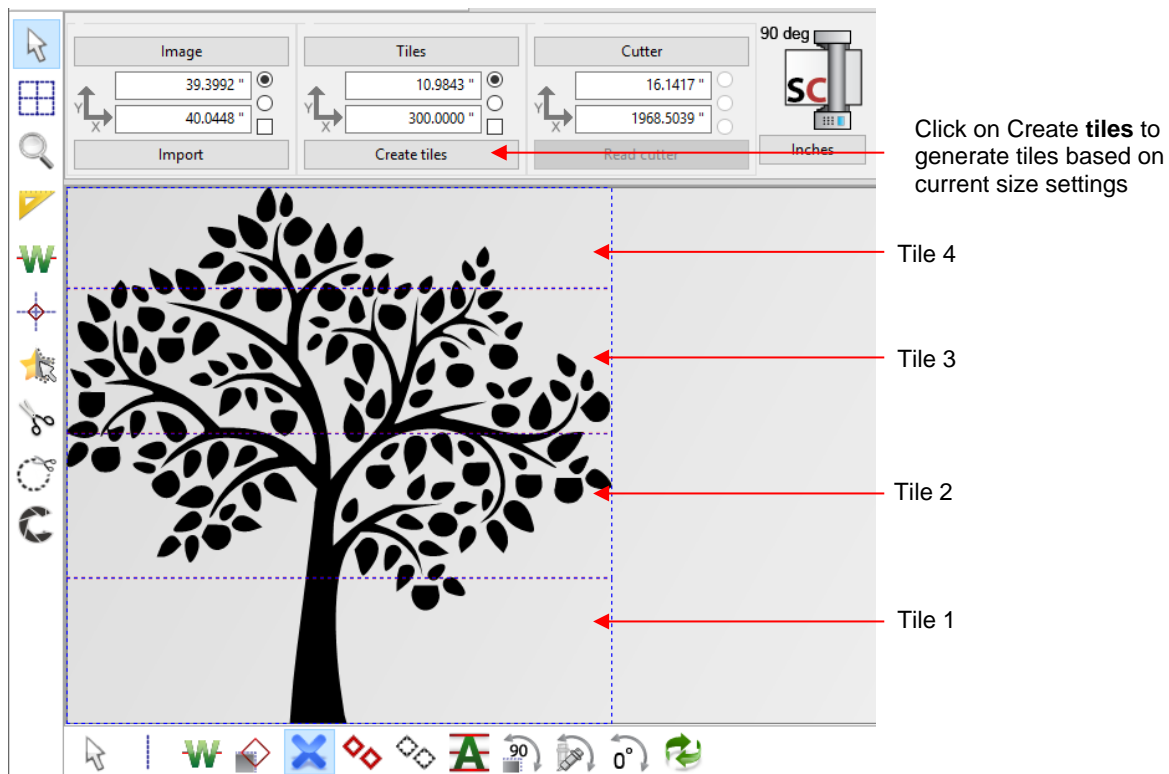

Click on **Create tiles** to generate tiles based on current size settings

◇ Note that the **Width** indicated as 10.9843" instead of 11" is a programming round-off error and is negligible in size.

- At this point, if you were to send the project to cut, all four tiles will be cut, one after another, as shown in the **Cut Out** window:

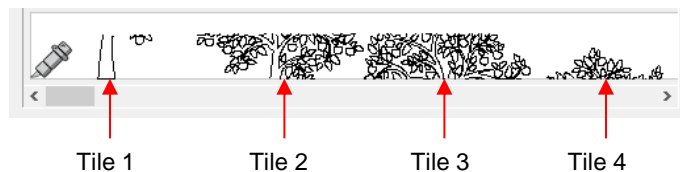

◇ If the **Mounting frame** option has been marked in the **Tile** settings window, then each tile would have been surrounded by a rectangle and the preview would appear like this:

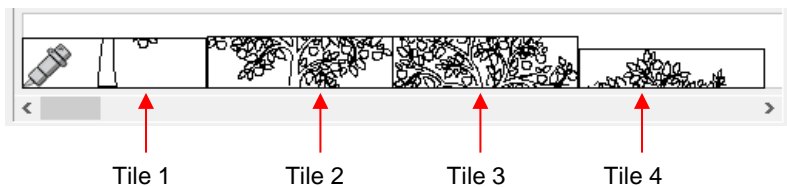

- If you prefer to not cut all of the tiles, click on the **Activate / deactivate tiles** icon  located on the sub-toolbar and click inside any tiles to deactivate:



- The **Cutout** window has additional tile settings whereby you can have copies of tiles made and specify the distance between each copy. For example:

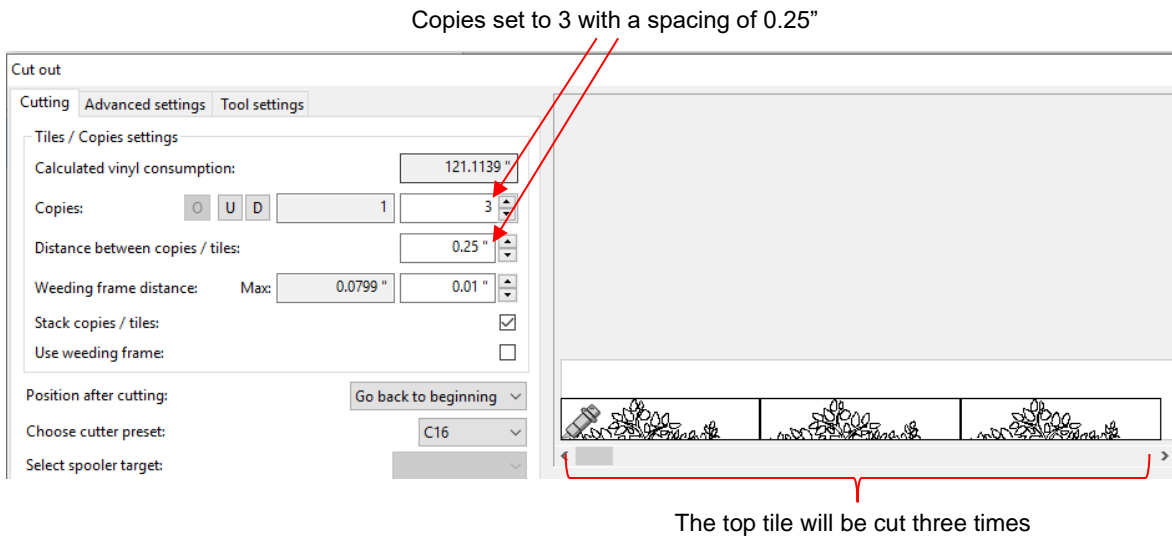

- Note the additional tile settings also available in this window:
 - Use weeding frame** and **Weeding frame distance**: Same as setting in the **Tile** window but conveniently located here in case it was forgotten.
 - Stack copies/ tiles**: when checked, tiles will be arranged across the width of the cutter, if space allows.

Manually Creating Tiles

- The **Tiling tools**  in SignCut Pro allow you to break up the design by clicking in the **Work Area** to add horizontal and/or vertical cut lines. Upon selecting the icon (or shortcut **W**), the sub-toolbar displays the following options:

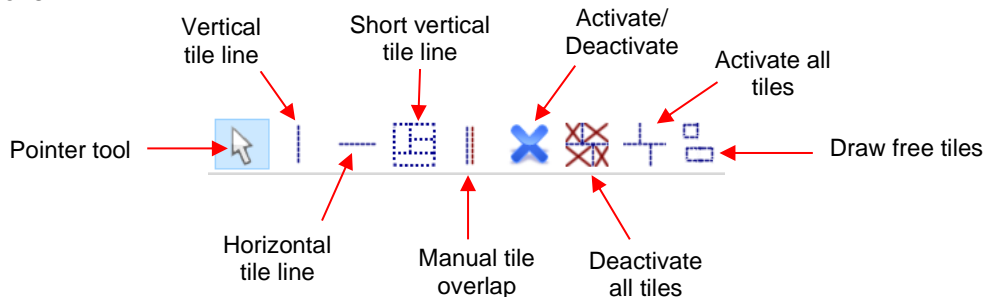

- The following example will be used to illustrate the use of the **Tiling tools**:



- ◇ Note the purple dashed line indicates that the design exceeds the maximum cutting width of the C16 Skycut, which will be used. This purple line is automatically the first tile line.

- Before covering each option, note the following:

- ◇ For most of the functions, left clicking the mouse will add a tile line. Holding **Shift** and/or **Ctrl** will provide additional options.
- ◇ Tiles lines can be dragged, as needed. In this example, the first purple tile line is dragged so that it is between the two lines of text:



- ◇ To delete a tile line, hold the **Ctrl** key and right click on the line. Note that if you delete a tile line that's required in order for the project to be cut based on a cutter's maximum limits, the tiles will automatically become deactivated:

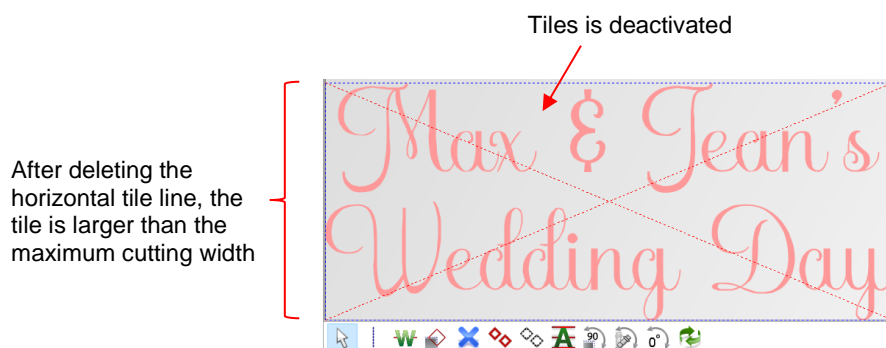

- **Add vertical tile line** - Left click once where you want a vertical tile line. Normally, when cutting from a roll of material, vertical tile lines won't be needed. But if the material on the roll isn't long enough for the entire project or if you prefer to cut using a cutting mat, then this option can be used:

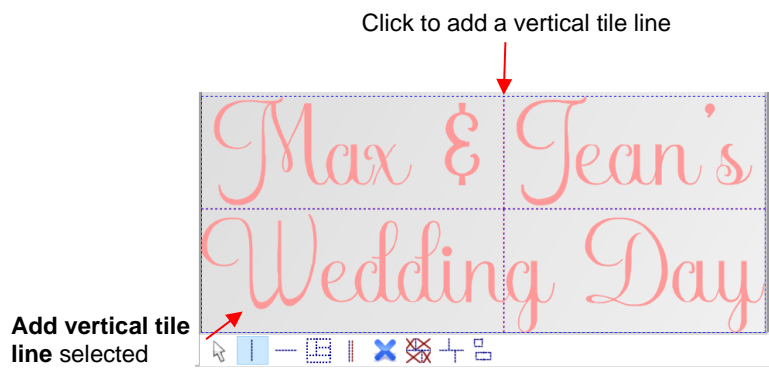

- ◇ Hold the **Shift** key while clicking and instead of creating a vertical tile line, another horizontal tile line will be added. While there is a second option on the sub-toolbar for adding horizontal tile lines, it can be more convenient to add them while in **Vertical tile line** mode if you're needing both types.
- ◇ Hold the **Ctrl** key while clicking to add a short vertical tile line:



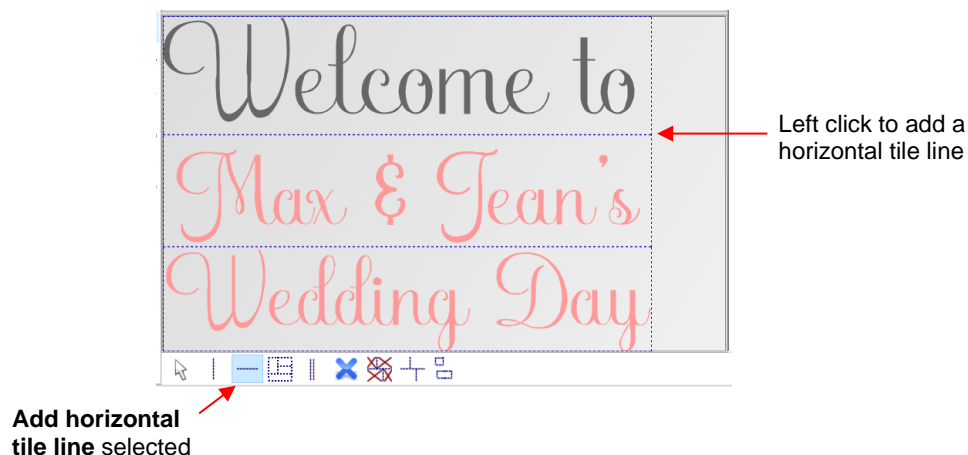

- **Add horizontal tile line**  - Left click once where you want a horizontal line. In this example, another line of text has been added to the design in SignCut Draw. In SignCut Pro, another horizontal tile line is added:



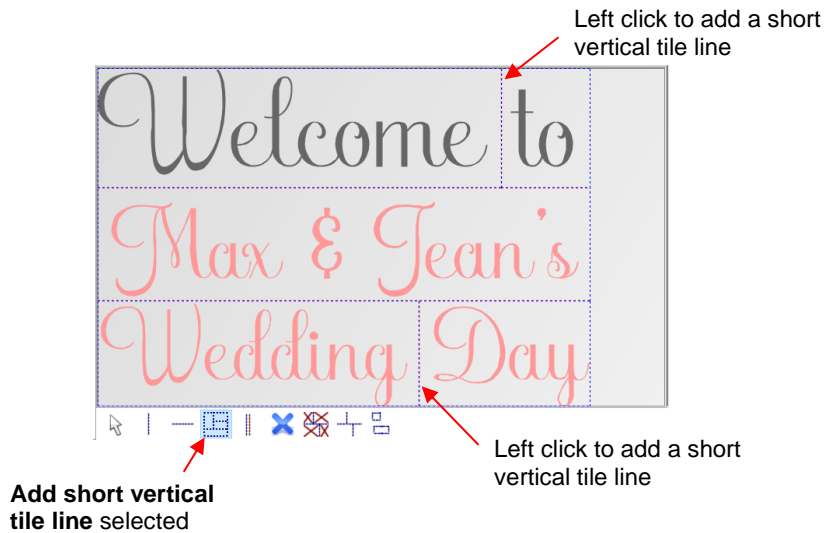

- ◇ Hold the **Shift** key and left click to add a vertical tile line, while in this mode.

- **Add short vertical tile line**  - Left click to add short vertical tile lines between horizontal tile lines:



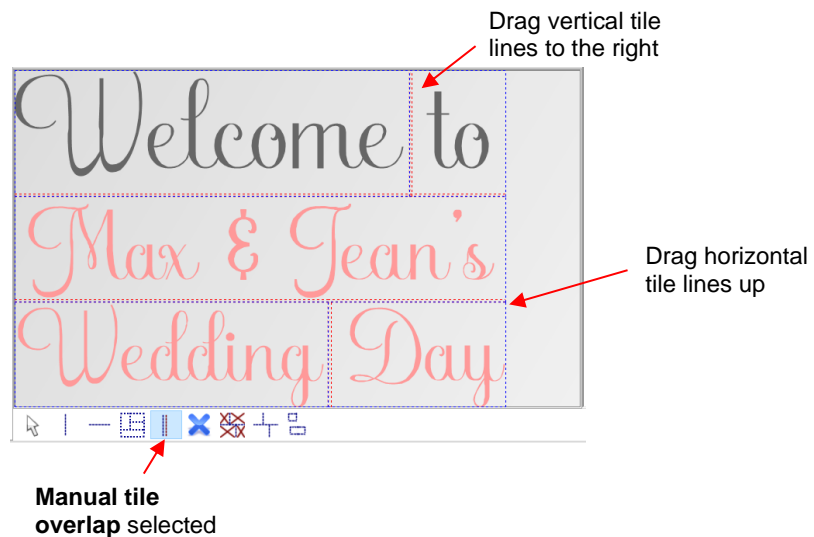

- Manual tile overlap**  - Some users prefer to have a small amount of overlap in the tiles so as to avoid any possible gap when aligning the cut pieces. To apply, drag an existing horizontal tile line upwards and/or drag a vertical tile line to the right:

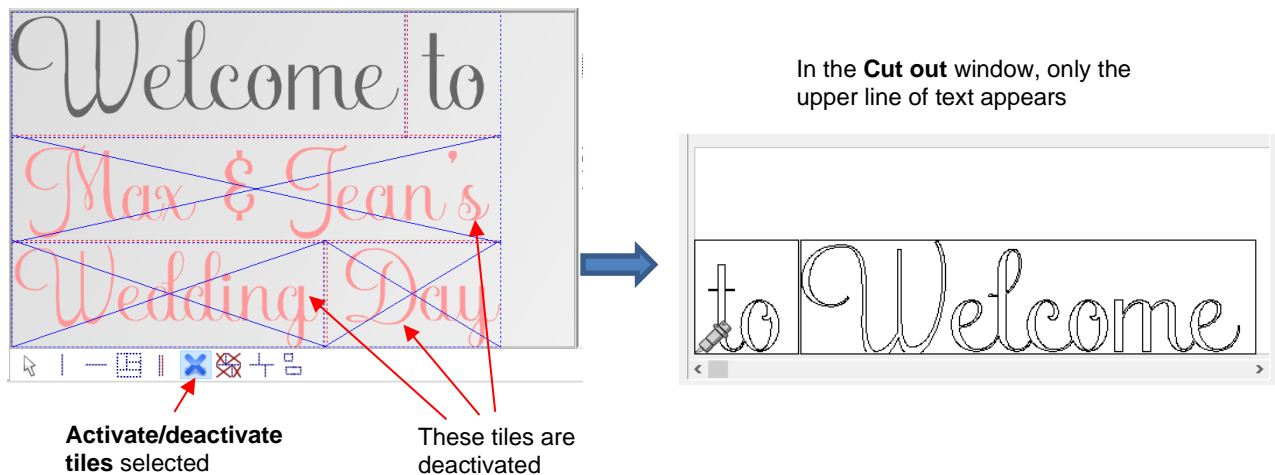

- Activate / deactivate tiles**  - as covered earlier, click inside any tile to toggle whether or not it is sent to the cutter for cutting. For example, the lower two lines are deactivated:



◇ The same tile settings in the **Cut out** window can be used to make additional copies with a specified spacing, add a weeding frame (in case it wasn't originally marked in the **Tile** window), etc.

- **Deactivate all tiles**  - click this icon to deactivate all of the tiles. The prior icon, **Activate / deactivate tiles** icon will now be highlighted and you can click on any tile to reactivate it, as desired.
- **Activate all tiles**  - click this icon to activate all of the tiles. As with the **Deactivate all tiles**, the mode will switch to **Activate / deactivate tiles** so that you can the individually deactivate any, as needed.
- **Draw free tiles**  - click this icon and then drag your mouse to create rectangular tiles where needed. For example, if a few parts of a design need to be recut, then rectangles can be draw around just those parts to create tiles to be sent to the cutter:

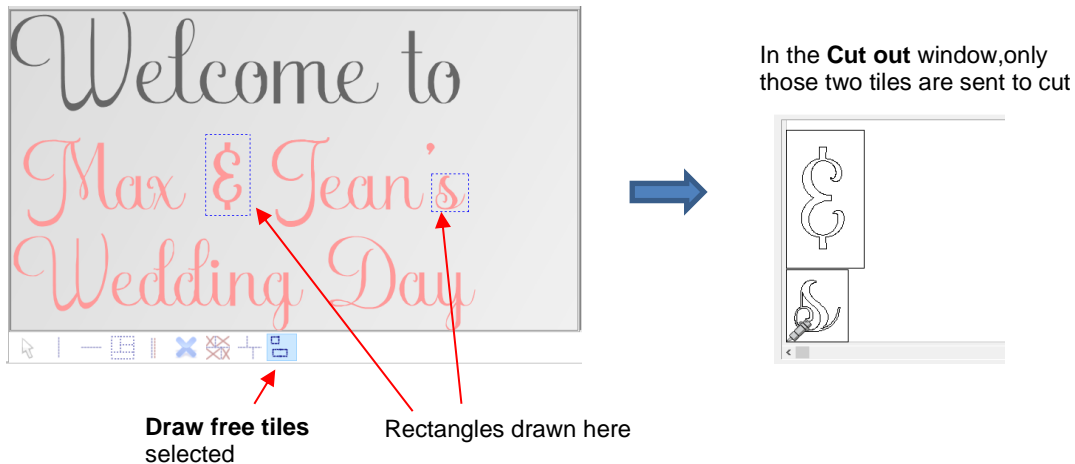

2.07 Important Checklist Before You Cut!

- Do you have your material on the mat and the mat inserted into the Skycut? (Note: materials with a backing sheet, such as vinyl and iron-on transfer do not require a mat for cutting)
- Have you selected pinch wheels positions that are roughly the same distance from the outside edges of the cutting mat (or material, if not using the mat)?
- Are the pinch wheels in use centered over grit shafts (located below the white rectangle labels)?
- Do you have the pinch wheel lever raised (so that the pinch wheels are down)?
- Have you set the blade length/exposure based on the thickness of the material you are cutting?
- Do you have the blade holder firmly mounted in the blade holder seat and the blade tip at the correct height above the material?
- Have you set the **Origin** (location of the blade tip) at the bottom right corner of your material (or wherever you need the origin to be)?
- Have you selected the correct mode on the control panel (**Left** versus **Right** versus **Double Head**)?
- Have you set the **Force**? And the **Speed**? Do you need to do a test cut?
- Do you need to turn on **Passes** for this material?
- Have you selected the correct **Blade Offset** for the blade you are using?
- Do you see the correct shapes in the preview window?
- Do you need to select **Rotate**, **Mirror** or **Absolute (Position)** options? Do you know, with confidence, where your shapes are going to cut?
- Do you need to apply any weeding options?

2.08 Scale Calibration

- If you were to cut out any particular shape, for example, a 10" x 10" square, you might find that it actually measures 9-15/16" x 10-1/32". It will be very close to 10" x 10" but perhaps just slightly smaller or larger in either or both dimensions. Now this might be perfectly acceptable for the type of cutting you do. Therefore, it may not even be necessary to do this particular calibration. However, if you do want to make sure your shapes are cut precisely to scale, the following procedure will allow you to calibrate your Skycut.
- Before beginning the calibration, it's a good idea to make sure the **Scale** values which can also be stored on the Skycut's control panel are set at a default of 1. Go to **Set>Advanced Settings> Scale**. The following window opens:

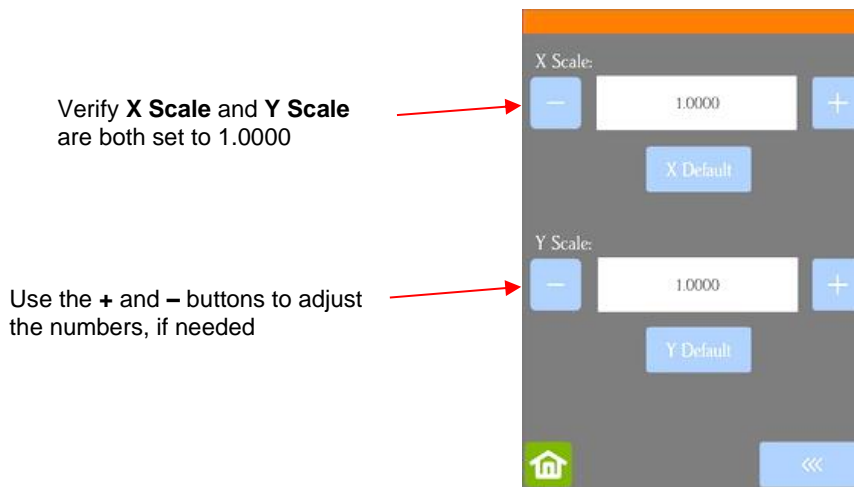

- In SignCut Draw click on the **Shape** tool on the **Tools** panel and then select the rectangle shape:

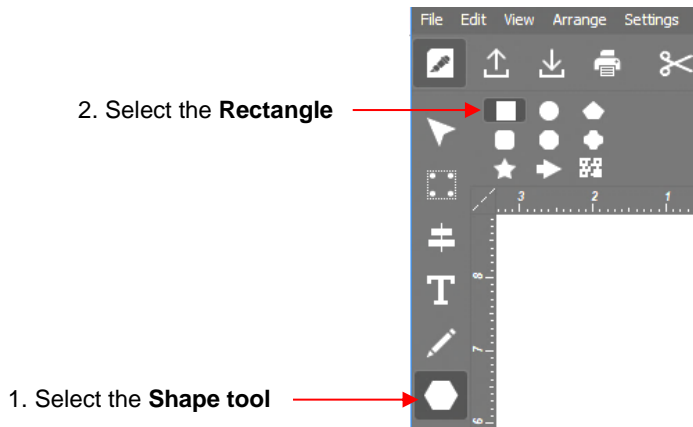

- Left click once in the **Sign Area**, press and hold the **Ctrl** key and move the cursor down and to the right. Click again to create a square. Later the dimensions will be set.
- The calibration process can be conducted in inches, cm, or mm. Both mm and inches will be presented here. In general, it is recommended that mm be used, however, if you do not have a metric ruler, then you can use inches instead.
- Pick one of the two following sections and follow the instructions. Once you have calculated your new **X Scale** and **Y Scale**, return to the screen above and enter the values using the **+** and **-** buttons.

2.08.1 Skycut Resolution Using Millimeters for Measurement

- In SignCut Draw, go to **Settings>Settings** and select **millimeter (mm)**:

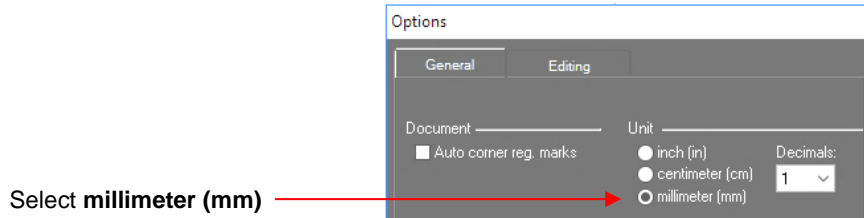

- With the square still selected, change the width and height to the largest size that will fit on the paper you have available. It is recommended that the square be at least 250 mm x 250 mm:

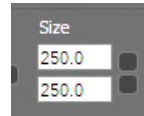

- Click on the **Move image to Signcut** icon to open the square in SignCut Pro. Use your test pen to draw the square. Leave the paper on the cutting mat so as not to confuse which sides drew left to right and which sides drew up and down.
- Using a mm ruler, carefully measure the **Width** (the left-to-right length that drew) and the **Height** (the top-to-bottom length that drew):

Feed the mat this direction
into the Skycut

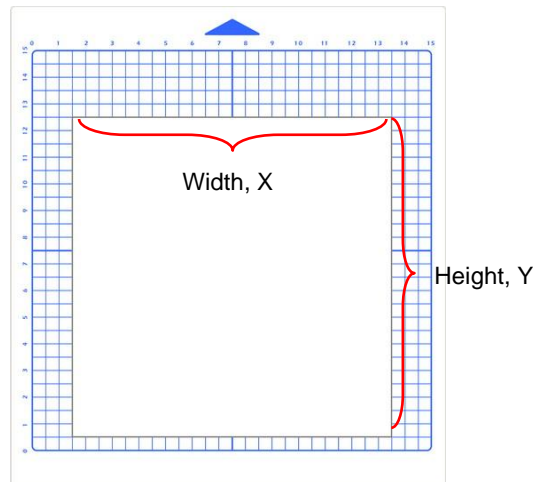

- Write those measurements onto your sheet:

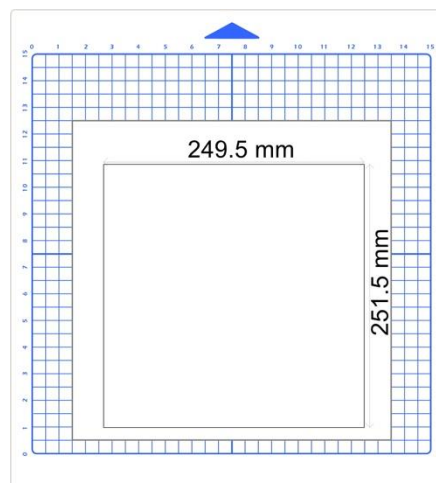

- Verify that the units are set to **Millimeters** on the **Cutter Panel**. If not, click on the button until **Millimeters** is displayed:

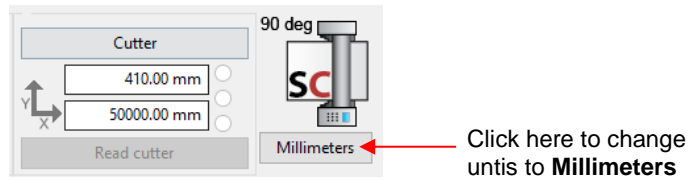

- To open the **Calibrate cutter size** window, click on the **Cutter** button on the **Cutter Panel**. Select the **Advanced settings** tab and, in that same window, click on the **Calibrate cutter size** button (lower right corner):

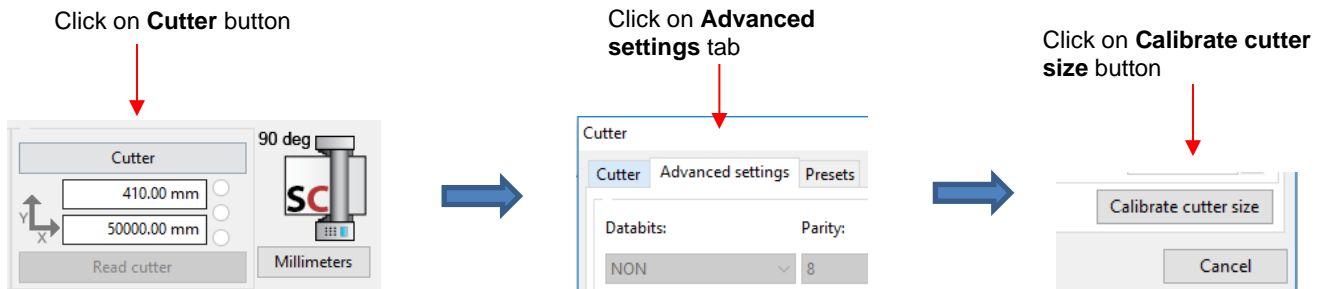

- The following window opens where you will enter the size of the square you sent to cut, along with the actual size the square drew:

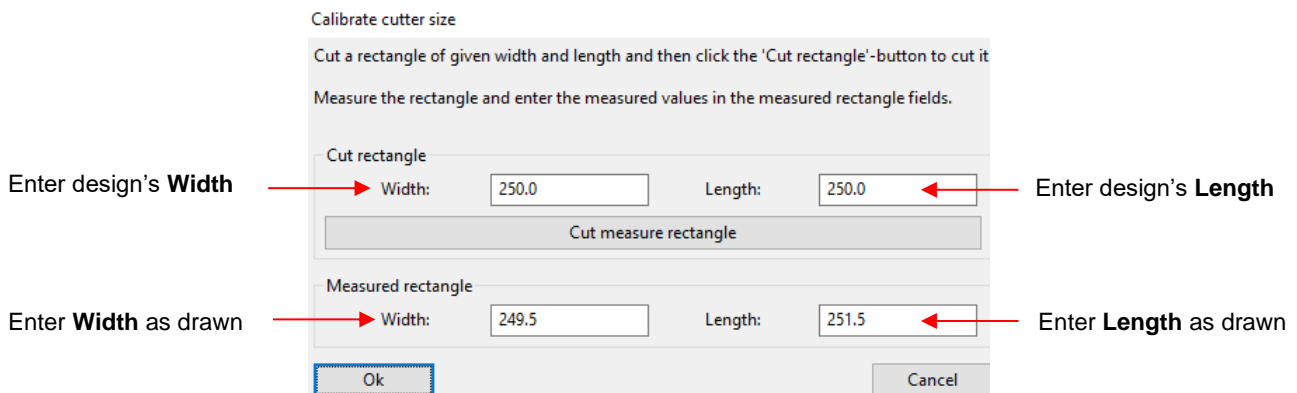

- Draw the square again and measure to verify the square is now 250 mm x 250 mm.
- Make adjustments as needed. For example, with the **Width** example above:
 - ◇ If the square is now drawing larger than 250 mm, then decrease the **Width** you entered as your measured value. Try entering 249.3 instead of 249.5.
 - ◇ If the square is still drawing smaller than 250 mm, then increase the **Width** you entered. Try entering 249.7 instead of 249.5.
- Once you have your calibration set, please record these values in your "little black book" in case your computer crashes and you lose your calibration.

2.08.2 Skycut Resolution Using Inches for Measurement

- In SignCut Draw, go to **Settings>Settings** and select **inch**:

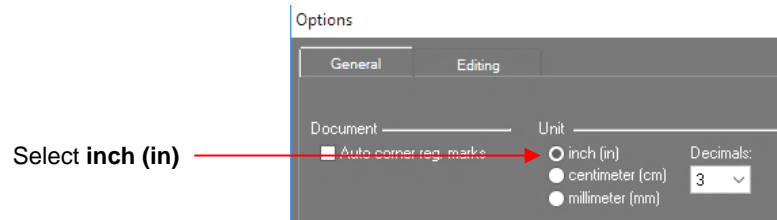

- With the square still selected, change the width and height to the largest size that will fit on the paper you have available. It is recommended that the square be at least 10 in x 10 in:



- Click on the **Move image to Signcut** icon to open the square in SignCut Pro. Use your test pen to draw the square. Leave the paper on the cutting mat so as not to confuse which sides drew left to right and which sides drew up and down.
- Using a ruler, carefully measure the **Width** (the left-to-right length that drew) and the **Height** (the top-to-bottom length that drew):

Feed the mat this direction
into the Skycut

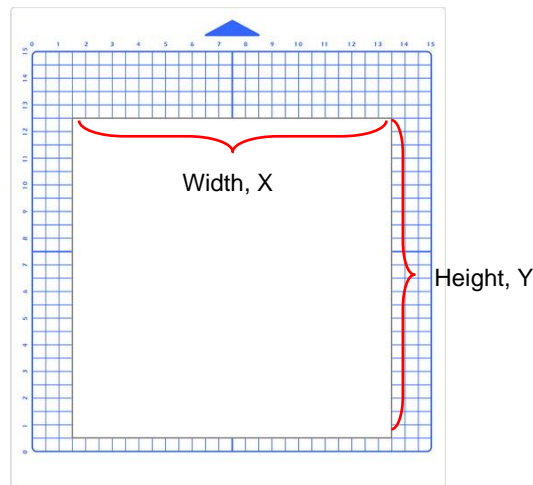

- Write those measurements onto your sheet:

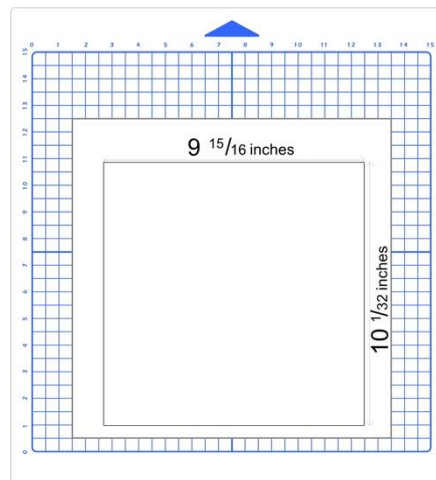

- Use a calculator to convert the fractions to decimals. In the example here, the **Width** would be 9.94 and the **Length** would be 10.03.
- Verify that the units are set to **Inches** on the **Cutter Panel**. If not, click on the button until **Inches** is displayed:

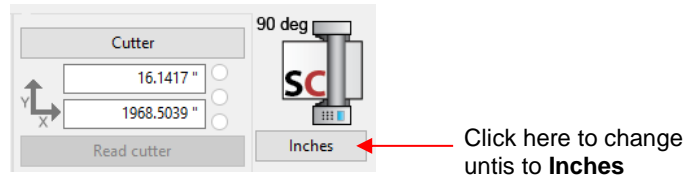

- To open the **Calibrate cutter size** window, click on the **Cutter** button on the **Cutter Panel**. Select the **Advanced settings** tab and, in that same window, click on the **Calibrate cutter size** button (lower right corner):

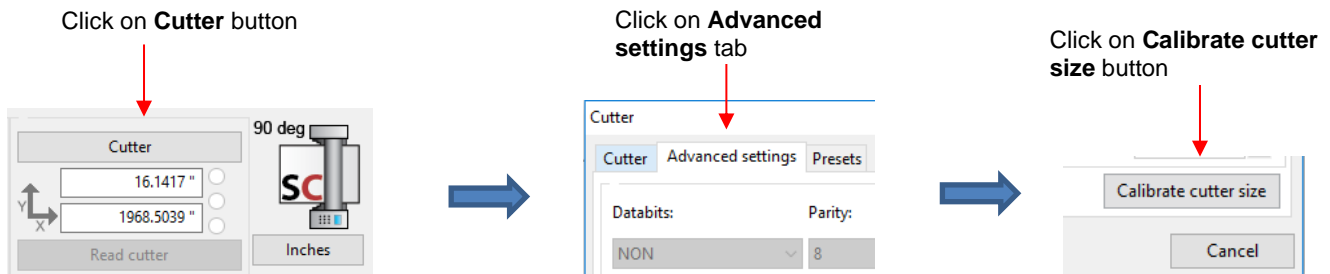

- The following window opens where you will enter the size of the square you sent to cut, along with the actual size the square drew:

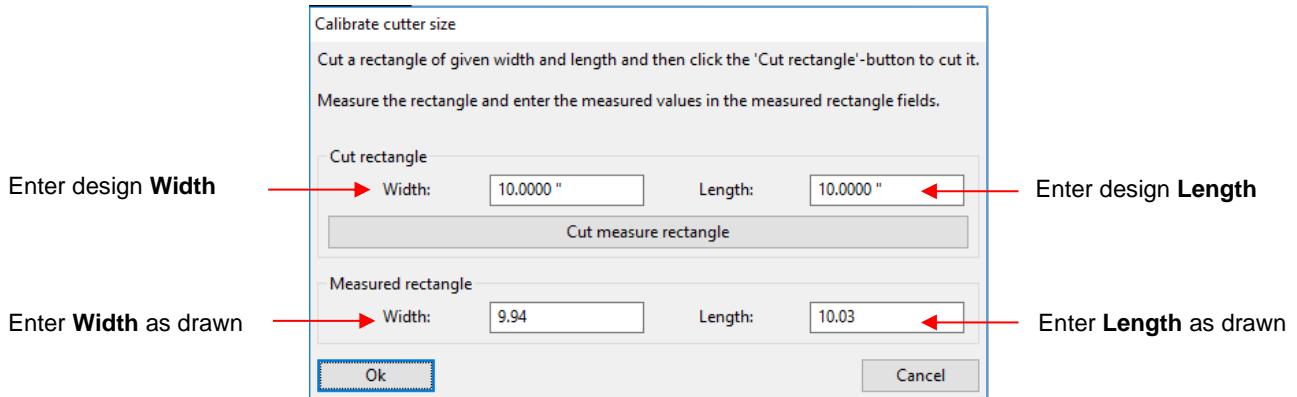

- Click on **Ok**. Draw the square again and measure to verify the square is now 10 in x 10 in.
- Make adjustments as needed. For example, with the **Width** example above:
 - ◇ If the square is now drawing larger than 10 in, then decrease the **Width** you entered as your measured value. Try entering 9.92 instead of 9.94.
 - ◇ If the square is still drawing smaller than 10 in, then increase the **Width** you entered. Try entering 9.96 instead of 9.94.
- Once you have your calibration set, please record these values in your “little black book” in case your computer crashes and you lose your calibration.

2.08.3 Scale Calibration Storage on the Control Panel

- The **Scale Calibration** results can be stored on the Skycut's control panel instead of within SignCut Pro. To do this, you'll need to calculate the actual scaling value based on the results you ended up entering in SignCut Pro.

Millimeters:

- On your Skycut control panel, go to **Set>Advanced Settings> Scale**. The following window opens where you can verify that the current **X Scale** and **Y Scale** values are both set to 1.0000:

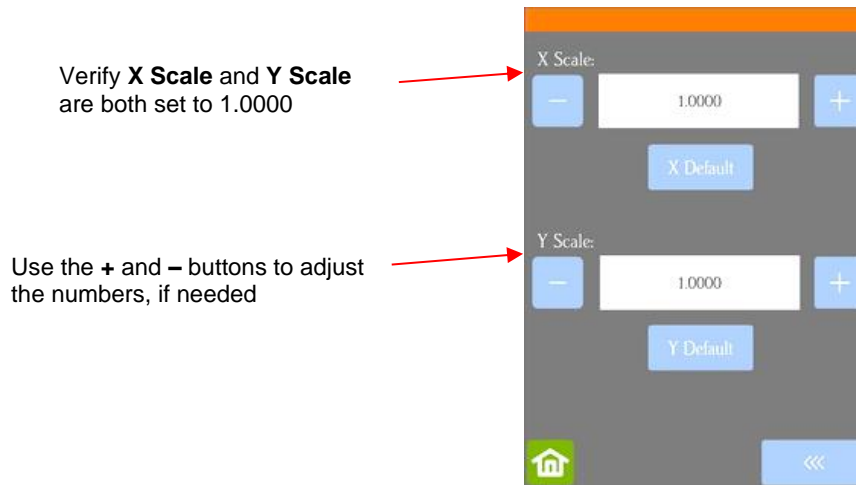

- Use a calculator to calculate the **X Scale** and **Y Scale** based on the measurements you obtained:

$$\begin{aligned} \text{New X Scale} &= \text{Width of the square in design divided by the measured width} \\ &= 250 / 249.5 \\ &= 1.0020 \end{aligned}$$

$$\begin{aligned} \text{New Y Scale} &= \text{Height of the square in design divided by the measured height} \\ &= 250 / 251.5 \\ &= 0.9940 \end{aligned}$$

- Return to the **Scale** screen (**Set>Advanced Settings>Scale**) and use the **+** and **-** buttons to enter these calibrations:



Inches:

- On your Skycut control panel, go to **Set>Advanced Settings> Scale**. The following window opens where you can verify that the current **X Scale** and **Y Scale** values are both set to 1.0000:

Verify **X Scale** and **Y Scale** are both set to 1.0000

Use the **+** and **-** buttons to adjust the numbers, if needed



- Use a calculator to convert the fractions to decimals based on the measurements you obtained:

$$\begin{aligned}\text{New X Scale} &= \text{Width of the square in design divided by the measured width} \\ &= 10 / 9 \frac{15}{16} \\ &= 10 / 9.9375 \\ &= 1.0063\end{aligned}$$

$$\begin{aligned}\text{New Y Scale} &= \text{Height of the square in design divided by the measured height} \\ &= 10 / 10 \frac{1}{32} \\ &= 10 / 10.03125 \\ &= 0.9969\end{aligned}$$

- Return to the **Scale** screen (**Set>Advanced Settings>Scale**) and use the **+** and **-** buttons to enter the calibrations:



- Draw the square again and measure to verify the square is now 10 in x 10 in.
- Once you have your calibration set, please record these values in your “little black book” in case you ever need to reset your Skycut to default settings or install a firmware update.

2.09 Test Cutting Flow Chart for the Skycut

- Select a small test shape. You can use the built-in test on the Skycut. However, a shape with an internal path, such as a ring, works better as it allows you to more easily check to see if the blade is cutting into the backing sheet or cutting mat.
- Start with conservative **Force** and **Speed**.
- Insert the blade holder as instructed in *Section 2.01.3*.
- On the control panel: **Set>Advance Mode**, choose **to End** or **to Left** and enter a small distance, such as 0.5" or 10 mm to space each test.
- Set origin in the lower right corner of the material.

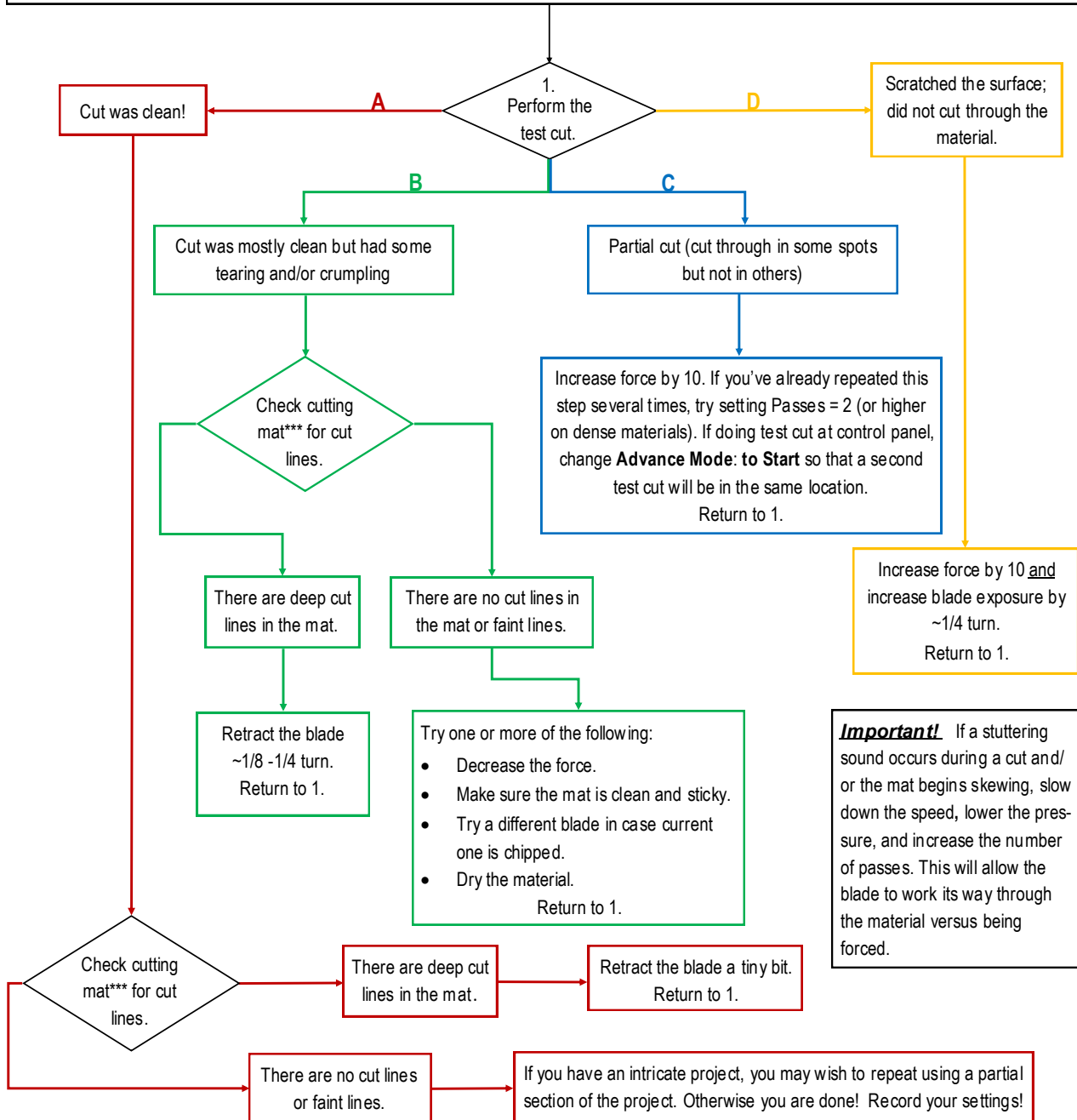

*** or backing sheet, such as with vinyl

2.10 Settings Form for Cutting Materials

<u>Material</u>	<u>Material Brand or Source</u>	<u>Blade</u>	<u>Force</u>	<u>Speed</u>	<u>Blade Offset</u>	<u># Passes</u>	<u>Other Comments</u>

2.11 Suggested Settings for Various Materials

IMPORTANT: These settings should be used for the initial test cut only. Adjustments may be necessary based on the condition of the blade, variations in the material, humidity, condition of the cutting mat, blade tip height, etc. Refer to *Section 2.09* for a guide to adjusting settings for optimizing the test cut.

Material Type	Material Brand/Source	Blade	Passes	Force	Speed	Other Comments
Cardstock: light	Light 65 lb (~176 gsm) Recollections	R	1	35	8	
Cardstock: medium	Medium: Textured Bazzill	R	1	40	8	Blade tip ht = 40 Post It notes
Cardstock: heavy	Accent Opaque 270 gsm (100 lb cover)	R	1	75	5	
Chipboard: cereal box	0.018" (0.4 mm)	B	1	50	5	Alt 2 passes at 40
Chipboard	0.022" (0.5 mm)	B	2	75	5	
Chipboard	0.03" (0.76mm)	B	2	95	5	
Chipboard	0.06" (1.5mm)	B: left R: right	3: on both	75: on both	1: on both	Duplicated image- right side cut / half-blade exposure; left side cut at required blade exposure; Blade tip ht = 20 Post It notes
Clay	Use a clay press (or pastry machine) to make clay thin	B	1	11	10	Make sure pinch wheels will not cross over the clay. Blade holder mounted on top of black seat.
Copy Paper	Most any brand	R	1	30	8	
Fabric - Cork	embroiderygarden.com	B	2	40	5	Blade tip ht = 25 Post It notes; use an extra sticky mat and taped around edges. Brayered well.
Faux Leather	~ 1.2 mm thick from Art of Fabric Folding (on Etsy)	B	1	50	6	Extra sticky mat w/ material upside down. (mirror imagem, as needed)
Faux Leather	AOUXSEEM 1 mm (available on Amazon)	B	2	50	8	Extra sticky mat w/ material upside down. (mirror imagem, as needed)
Foam - Plain	2 mm	B	2	25	10	
Foam - Glitter	Foamy - 2 mm	R	2	15	10	
Magnet	Marietta Magnetics - 0.02" (0.5mm) (20 mil)	B	2	90	8	
Magnet	0.035" (0.9mm)	B	2	50	3	Alt 1 pass at 85
Magnet	Marietta Magnetics - 0.02" (0.5mm) (20 mil)	B	2	90	8	

Material Type	Material Brand/Source	Blade	Passes	Force	Speed	Other Comments
Tracing Paper	Helix Vellum Paper	R	1	30	8	
Vinyl - Heat Transfer	Siser EasySubli - with the mat	R	1	30	8	Cut on the mat
Vinyl - Heat Transfer	Siser Glitter - Gold - No cutting mat	R	2	35-40	7	2 passes makes it easier to weed, also slight scratch cut in the backing layer
Vinyl - Heat Transfer	Siser Glitter - Gold - with the mat	R	2	45-50	7	2 passes makes it easier to weed, also slight scratch cut in the backing layer
Vinyl - Wall (no mat)	Vinyl - Oracal 631 - yellow	R	1	25	8	
Vinyl - Wall (on mat)	Vinyl - Oracal 631 - yellow	R	1	30	8	
Vinyl - Waterproof	Papilio	R	1	30	8	

3. Print and Cut (Contour Cut)

Video

3.00 Quick Reference for Chapter 3

- How to calibrate the camera: *Section 3.03.2*
- How to set up a contour cut: *Section 3.04*
- How to adjust the camera calibration: *Section 3.05.1*
- How to add more registration marks: *Sections 3.06.2 and 3.06.3*
- Troubleshooting inaccurate print and cut results: *Section 3.05*
- How to set up repeats: *Section 3.06.1*
- How to do a PNC from a USB flash drive file: *Section 3.07.1*
- How to use the **Array Mark** function on the control panel: *Section 3.07.2*

3.01 What Is a Print and Cut (PNC)?

- The print and cut process (also called PNC and contour cutting) involves printing an image from SignCut Pro2 to any printer you own and then, with the aid of the Skycut's camera, have the image or images cut out with perfect precision. Below are three typical kinds of print and cut applications but there can be other kinds.

- ◇ Cuts along the actual borders of the printed image(s):

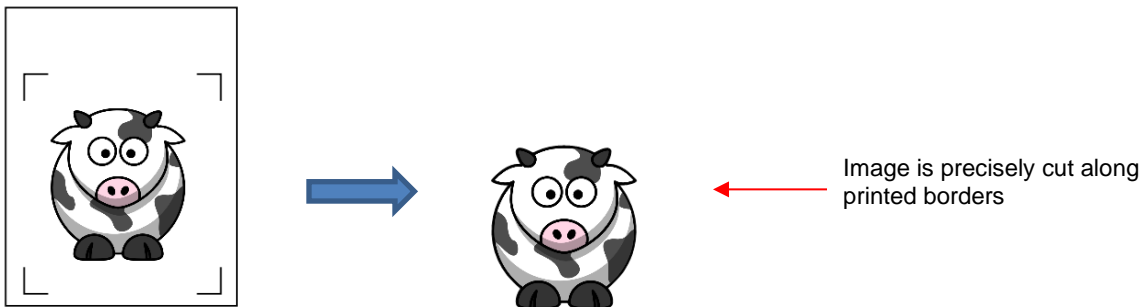

- ◇ Cuts outside of the borders but follows the shape(s) of the printed image(s):

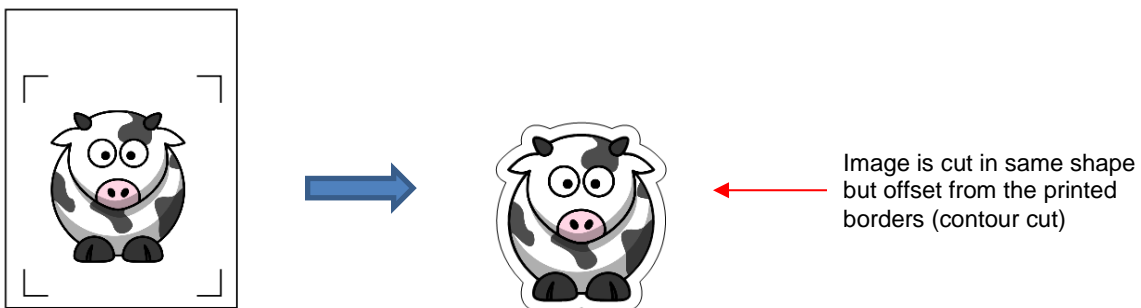

- ◇ Cuts follow a different shape from that of the printed image(s):



3.02 What is a PNC Calibration?

- In order to get precise PNC results, you must calibrate the camera. This is nothing more than letting the Skycut know how far away the camera lens is located relative to the tip of the blade. Because the camera is manually installed inside the blade carriage, the distance from the camera's center to the tip of the blade will vary from one Skycut to the next.
- This calibration only needs to be done one time. If you have travelled with your Skycut or it's been bumped fairly hard, you might want to run a test to make sure your calibration hasn't changed. It's also recommended that you check your calibration after any firmware updates are installed.
- The process, which is conducted through the control panel involves:
 - (1) Having the Skycut draw a test shape. At that point the camera takes a photo and displays it on the control panel, along with a red + and a large blue dashed +.
 - (2) Aligning the red + with the center of the test shape display several times until the blue dashed + is centered with the test shape.

3.03 Camera Calibration Procedure

3.03.1 What You Need for Calibrating

- You need the following items for this calibration:
 - ◇ Sheet of paper
 - ◇ Test pen that came with your Skycut

3.03.2 Calibration Process

- (1) Insert the test pen into the Skycut on the left side blade holder seat. Place the sheet of paper into the Skycut. You can use the cutting mat to hold the paper or insert the paper directly.
- (2) Use the arrow keys on the control panel to move the test pen over the sheet of paper.
- (3) Also, on the control panel, if the double head options are displayed, make sure the **Use L Head (P0)** option is selected:

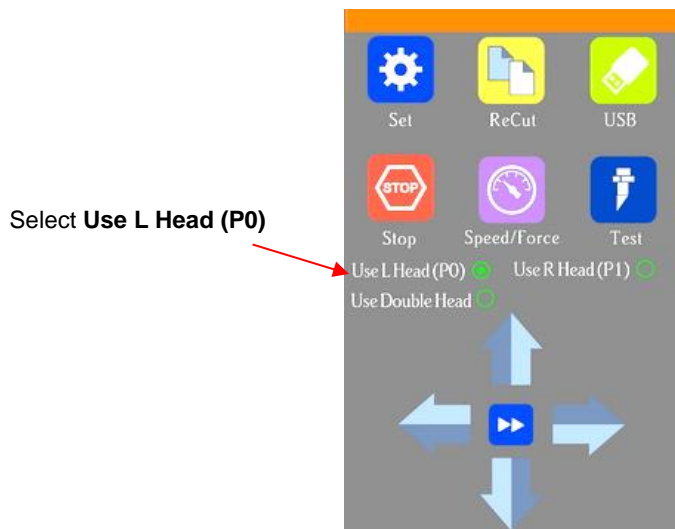

- (4) Select **Speed/Force** and set **SPEED** to ~ 8 and **FORCE** to ~ 30. Click on **Test** to verify that a square is clearly drawn. If it is too faint, increase **FORCE** as needed and repeat.
- (5) Move the pen an inch or two away from the test so that there is room for the calibration shape to be drawn.
- (6) On the **Main Screen**, press **Set** and then **Camera**:

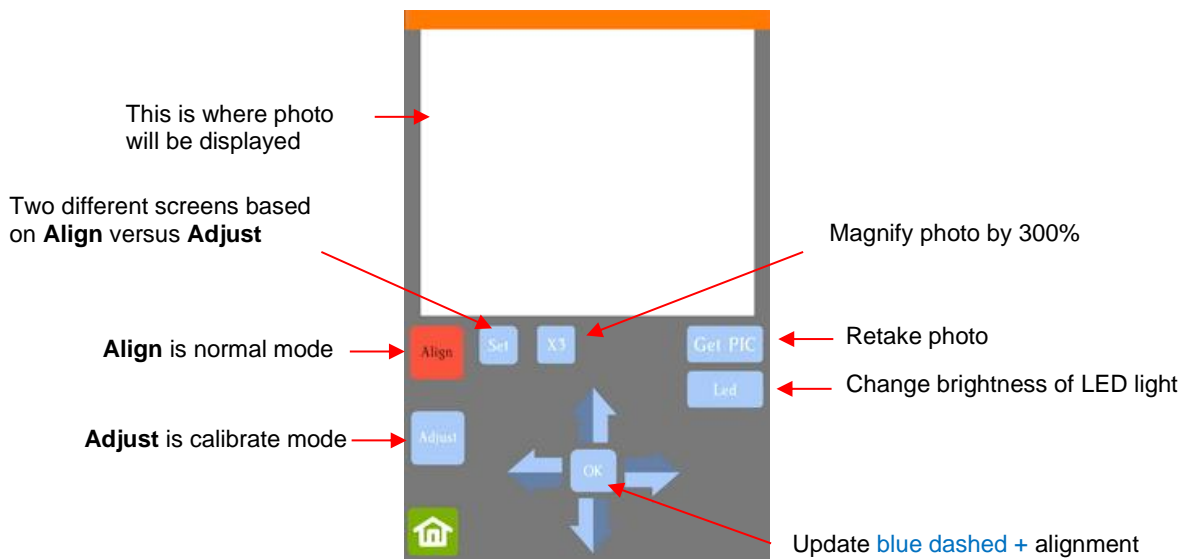

- (7) Press **Adjust** to switch to calibrate mode and a new **Start** button will appear in the lower right corner of the **Camera Screen**:

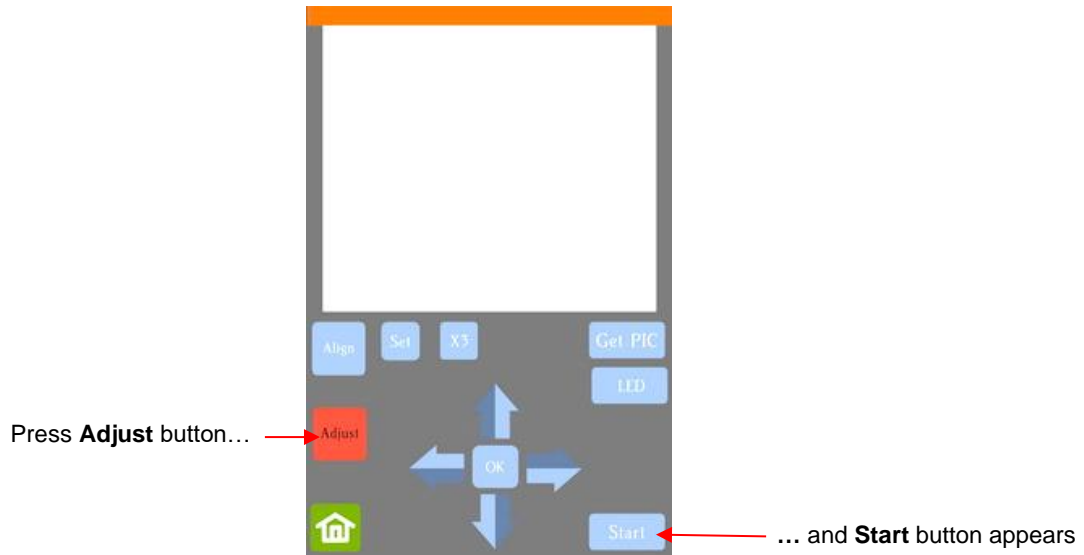

- (8) Press **Start**. The test shape, which is a square with a **+** inside, will be drawn on the paper and the camera will move over the test shape, take a photo, and display the photo on the control panel. If you cannot see the test shape clearly, press the LED button once so that it reads LED 50% and press the **Get PIC** button. You should see three items in the photo: the test shape that was drawn with the pen, a **red +**, and the **blue dashed +**:

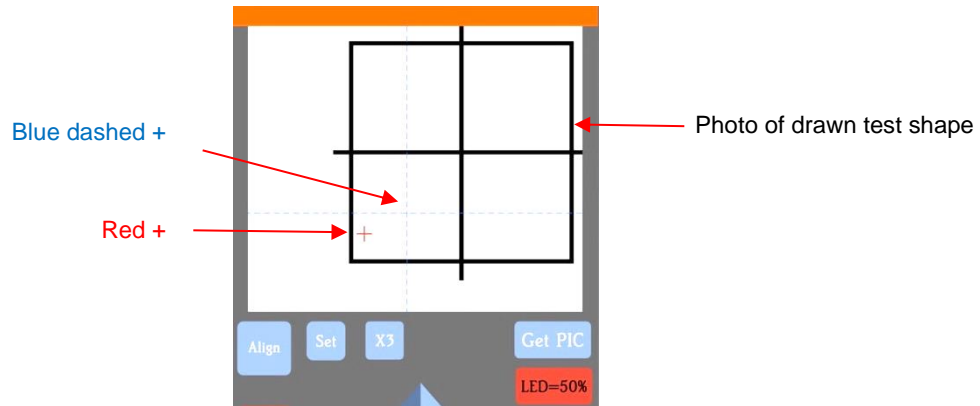

- (9) Tap your finger near the middle of the drawn test shape. This will move the **red +** to that location. Then press **OK**. A new photo will be taken:

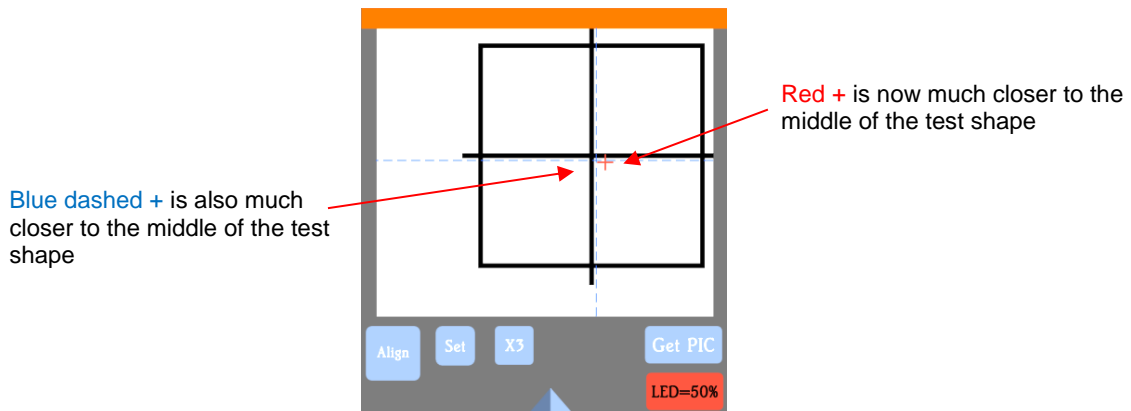

- (10) Press **X3** so that a magnified version appears:

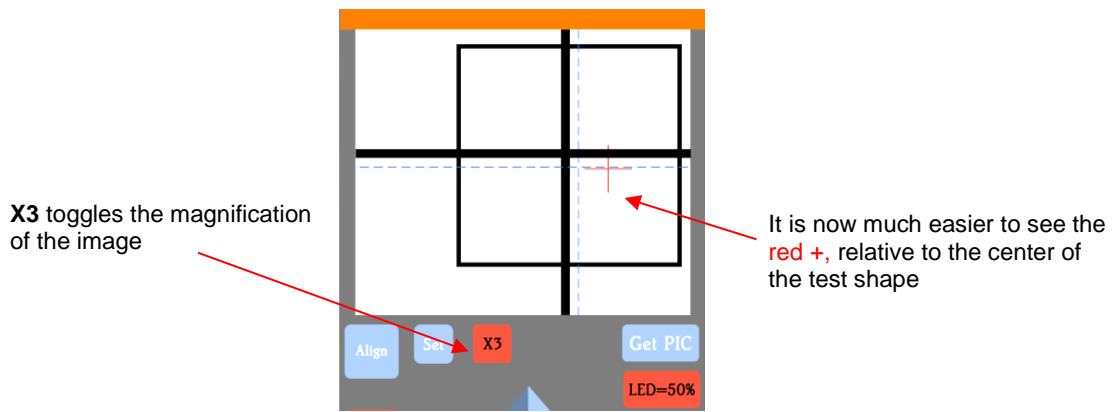

(11) Use the arrows keys to move the center of the **red +** to the center of the test shape:

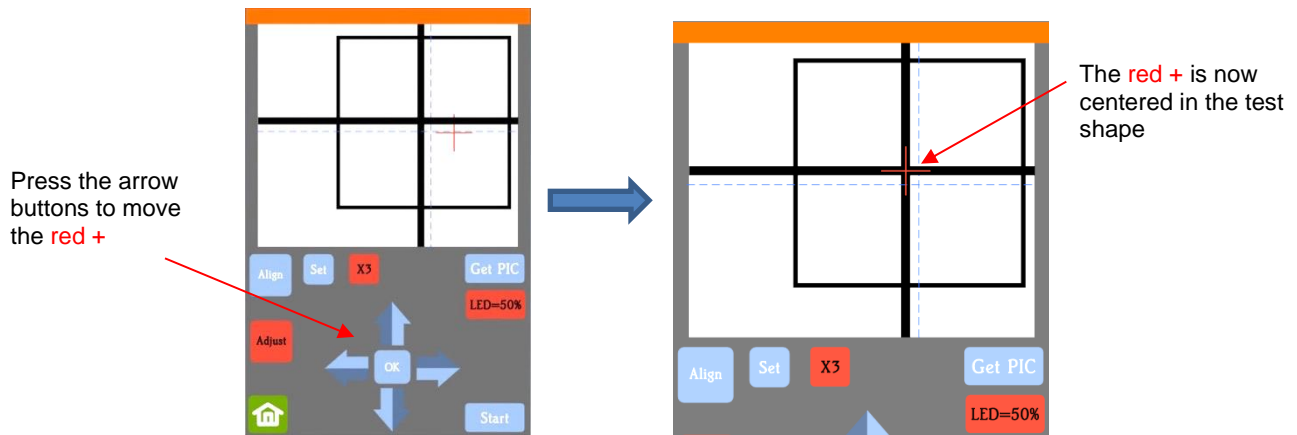

(12) Press **OK** and a new photo will be taken. The **blue dashed +** should now be more closely aligned with the center of the test shape:

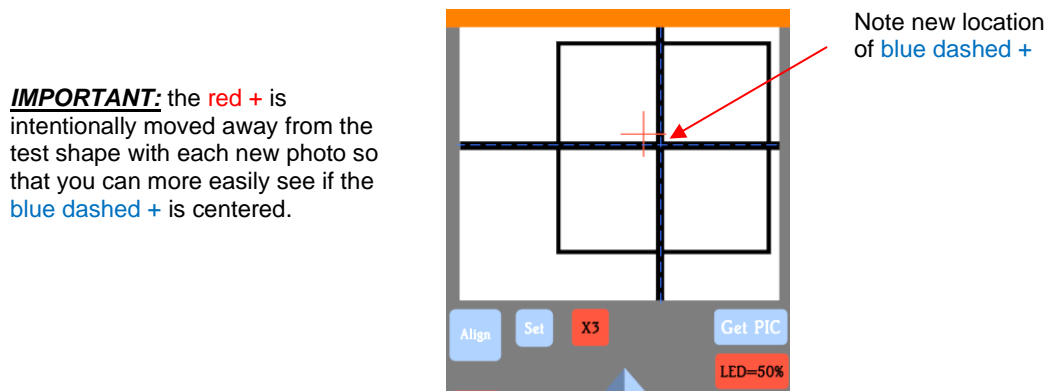

(13) If necessary, repeat *Steps 10 and 11* until the **blue dashed +** is near-perfectly centered in the test shape.

(14) Press **X3** to return to normal magnification. Click on the **Home** icon to return to the **Main Screen**. Your Skycut is now calibrated for print and cut (PNC) applications.

3.04 Performing a PNC in SignCut Pro

3.04.1 Summary of Steps

- Here are the typical steps when performing a contour cut application:

- ◇ Prepare the image(s) that will be printed and cut. These typically include one or more of the following:
 - An imported raster image such as a JPG or PNG or BMP file
 - A vector image (imported, designed in SignCut Draw, or traced from the raster)
 - Text
- ◇ Prepare the appropriate registration marks:
 - Open a template file that has registration marks
 - Have registration marks added in the software
- ◇ Print the project after selecting appropriate printer options.
- ◇ Perform a test cut so that you know the best cut settings to use for the printed material. This test cut can often be performed on the printout itself if there is room in the waste area of the project.
- ◇ Perform the cutting process from SignCut Pro2.

3.04.2 Preparing the Registration Marks

- There are two options for adding registration marks in SignCut Draw for use with the Skycut:
 - ◇ Option A: Open a template file with registration marks already in place
 - ◇ Option B: Add registration marks from within SignCut Draw
- Both of these will be covered in this section. However, note that currently the first option is the only one working correctly with the Skycut models.

Option A. Using a Template File with Registration Marks

- One of the registration mark templates will be used. These templates can be downloaded from [this link](#):
- After extracting the files, open either the *Letter* or *A4* file. At this time, do not use one of the templates that contains intermediate registration marks. This will be covered in *Section 3.06*.

Option B. Adding Registration Marks from within SignCut Draw

- While it's not a requirement, it can be helpful in designing if the **Drawing Board** dimensions match the printout size you plan to use. For this tutorial, **Letter** size (8.5" x 11") will be used. But you can use much larger sizes, if you have the ability to print in those dimensions.
- To change the **Drawing Board** dimensions, click on the **Sign setup** icon  on the **Tools Panel** (or press the shortcut **W**). The following appears on the **Properties & Functions Bar**:

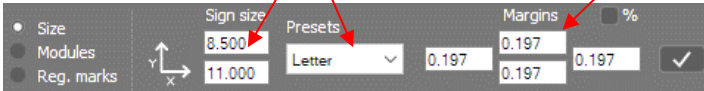

1. Select **Size**

2. Select from the **Presets** menu or enter custom dimensions

3. Enter **Margins**

4. Click on **Apply**

- ◇ It's important to use **Margins** because the registration marks will be aligned with them. However, on a Skycut, these registration marks can be fairly close to the edges of the printout.
- In this same **Sign setup** mode, click on the **Reg marks** option and change settings to the following:

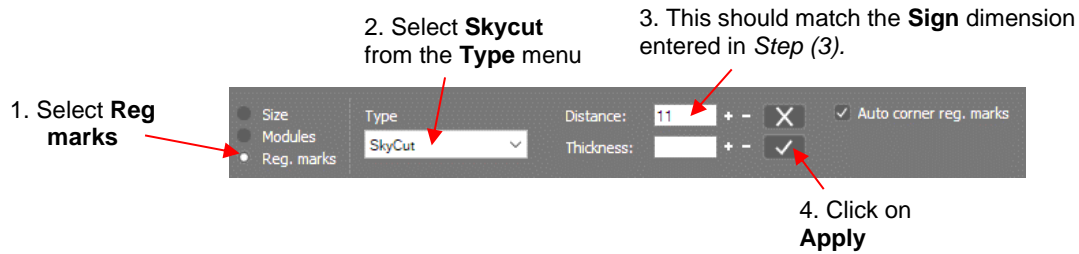

◇ **Distance:** This setting can be made smaller if intermediate registration marks are needed. Refer to *Section 3.06.3*.

3.04.3 Contour Cutting Project – Accuracy Test

- (1) For the initial testing of a contour cut, it is highly recommended that several arrows be used as they will indicate if the camera calibration is accurate.
- (2) Using the same method presented in *Section 1.13.3*, add several arrows spread out in the **Sign Area**:

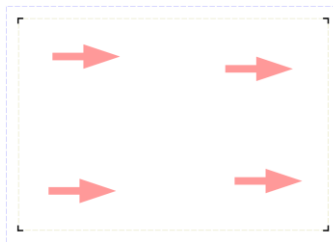

- (3) Go to **File>Print** and verify the following:

Print size: choose either **Letter** or **A4** to match the template you chose

If the project contains a raster image, mark the **Bitmap** option

If Option B was used to add registration marks, mark this option

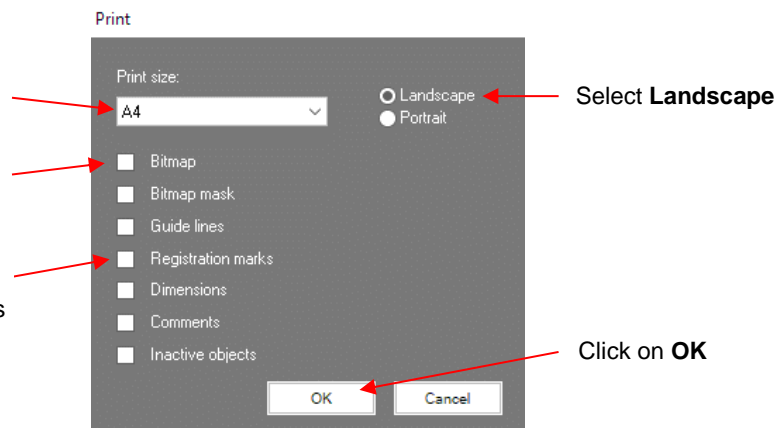

- (4) Click on **OK** and a second **Print** window will open where you can select the printer you wish to use. This window will vary based on the printer brand and model:

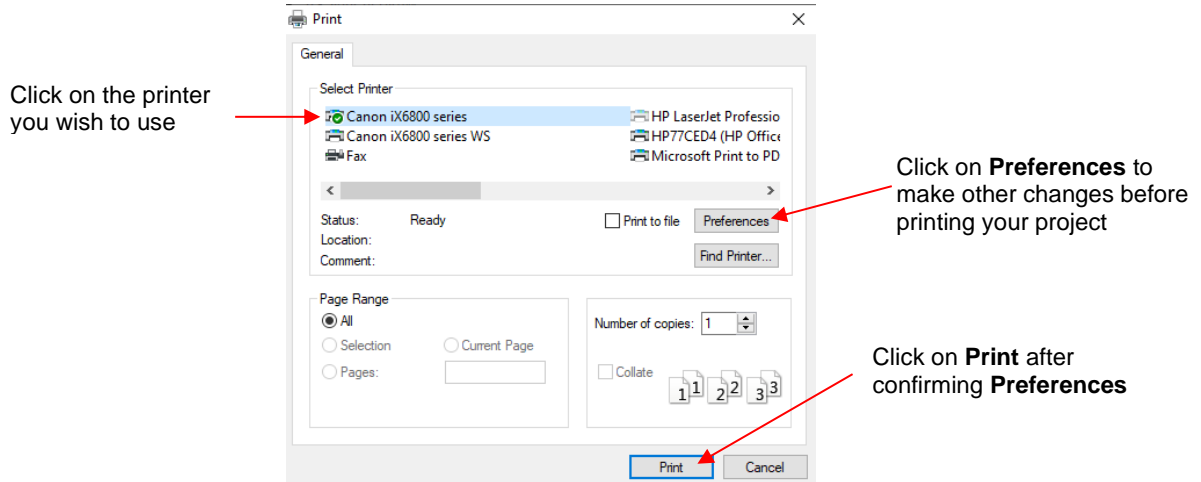

- ◇ The **Preferences** window should always be checked unless you are certain the defaults match your needs. This window will also vary by printer but, as an example, here are some settings you may need to verify:

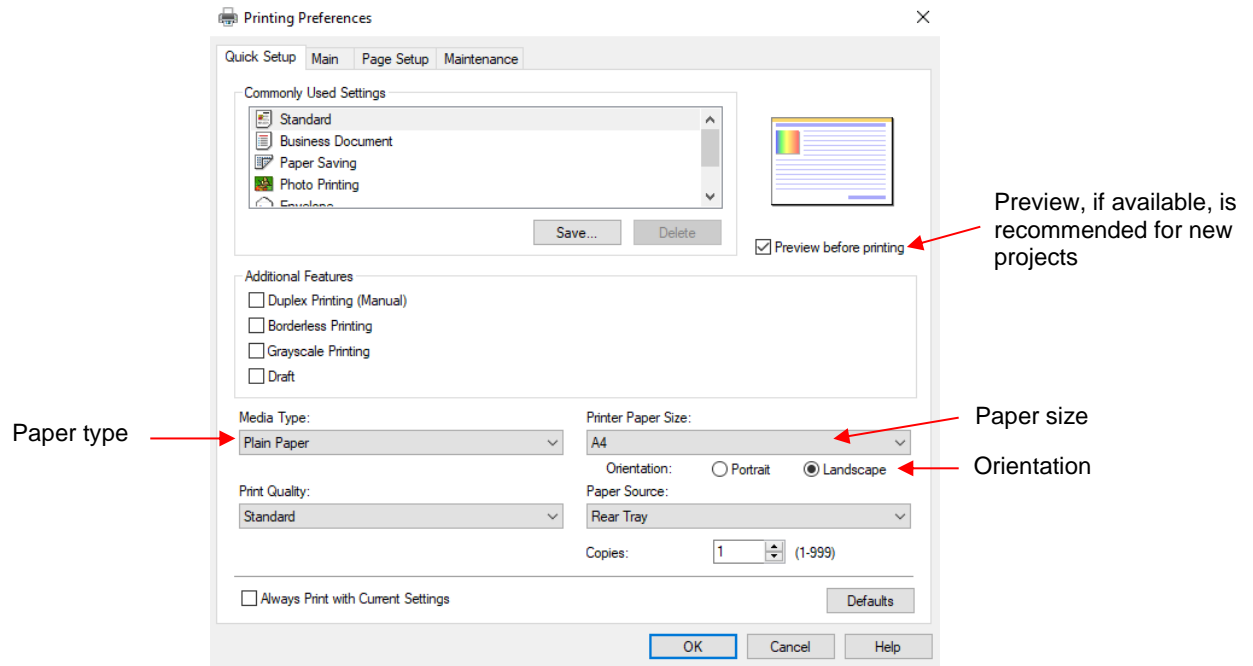

- ◇ **IMPORTANT:** Borderless printing can move the registration marks relative to where they are positioned in the design project. If you need to activate this setting, please read the following document:

<https://tinyurl.com/y66u5lzf>

- ◇ Click on **OK** and then **Print** to produce the printout for cutting.

- (5) To transfer the project to SingCut Pro, click on the **Move image to SignCut** icon  (or shortcut **S**). The cut lines and registration marks will appear:

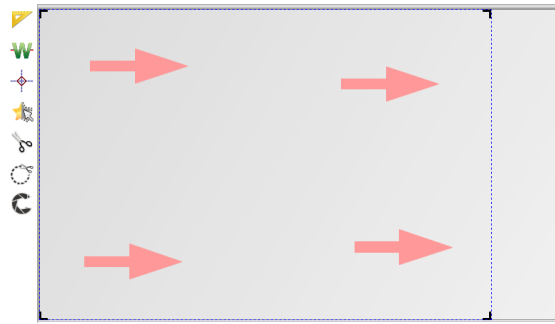

(6) Place the printout onto the cutting mat or load the printout directly if a cutting mat isn't required. Note that in

SignCut Pro, you can use the cut preview window (click on the **Cut out** icon  or press the shortcut **I**) to verify the orientation based on the location of the first reg mark to be scanned:

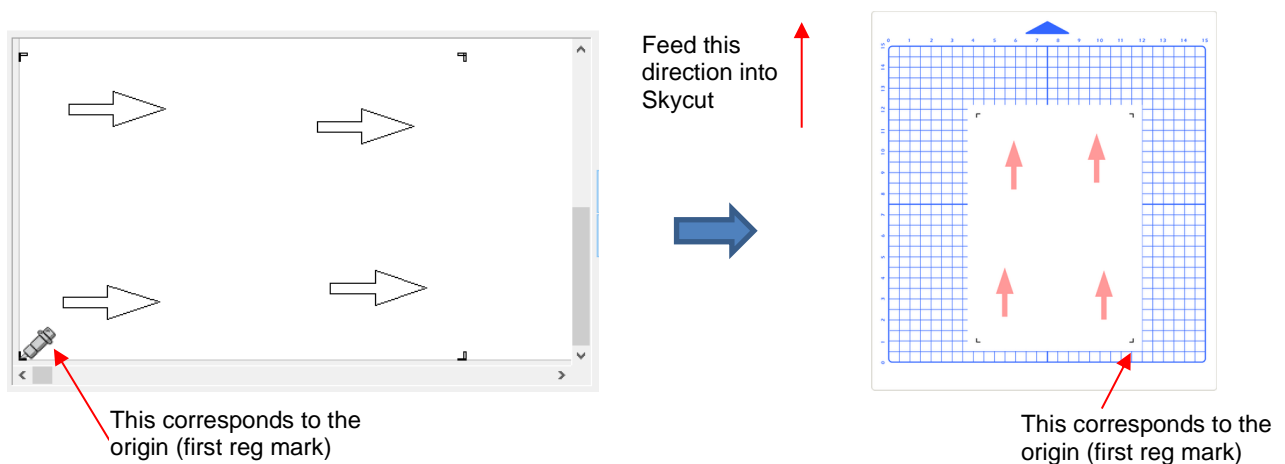

(7) Load the mat and/or printout so that it is straight, relative to the cutter. The alignment doesn't need to be absolutely perfect but close enough that it will allow for a faster and, of course, successful detection by the camera. Set the **Speed** and **Force** (either from within SignCut Pro or on the control panel itself). Insert the blade holder and perform a test cut, as needed, adjusting the cut settings.

(8) Place the blade holder over the first registration mark. In the main SignCut Pro window, click on the

Contour cut icon .

(9) Click on **Next** and the Skycut's camera will now move over each registration mark, take a photo, and make an adjustment. Once it has read all four marks plus the first one a second time, it will proceed to cut out the printed shapes. Note which arrow cuts first because it's the one that should be used for any adjustment to the calibration values. If there is a difference in the offset with the other arrows, that indicates an issue with the cut settings. Refer to *Section 3.05.3*.

(10) After testing out this process, be sure to check out remaining sections in this chapter to understand additional options, such as:

- ◇ Adjusting camera calibration settings, if needed – *Section 3.05.1*
- ◇ Other reasons for inaccurate results – *Sections 3.05.2 and 3.05.3*
- ◇ How to set up a grid of repeats – *Section 3.06.1*
- ◇ Adding additional registration marks to improve accuracy on long cuts – *Sections 3.06.2 and 3.06.3*
- ◇ Performing a PNC using the USB flash drive – *Section 3.07*

3.05 Inaccurate Cuts

- There are several reasons why your print and cut results may not be as accurate as you need:
 - ◇ The calibration needs to be adjusted
 - ◇ The contours around the printed image are not accurate
 - ◇ The cut settings or pinch wheels need to be adjusted
- The following sections present solutions for each of these.

3.05.1 Adjusting the Calibration Values

- If you find the first shape being cut is slightly off, you can adjust the values being used versus attempting to recalibrate from scratch.
- To do this, go back to an easy-to-cut material like copy paper and use a shape that has both horizontal and vertical lines, such as the arrows that were suggested in *Section 3.04.3*. This makes it easier to know if you need to adjust in the **X** (left-to-right) direction or in the **Y** (up-and-down) direction.
- After performing the print and cut, use a mm ruler to measure how far away the cut lines are from the printed lines. If you used an arrow, focus only on the horizontal and vertical lines, not the diagonal lines:



- ◇ In this example, let's say the red cut line is about 0.5 mm too high and about 0.3 mm too far to the left. Thus, you need the cut line to move down and to the right.
- On the control panel, change the **Units** to millimeters by going to **Set>General Settings** and choosing millimeters, as was shown in *Section 1.14.2*.
- Go to **Set>Camera** and click on **Adjust**. Then click on **Set** to open the **Adjustment** window:

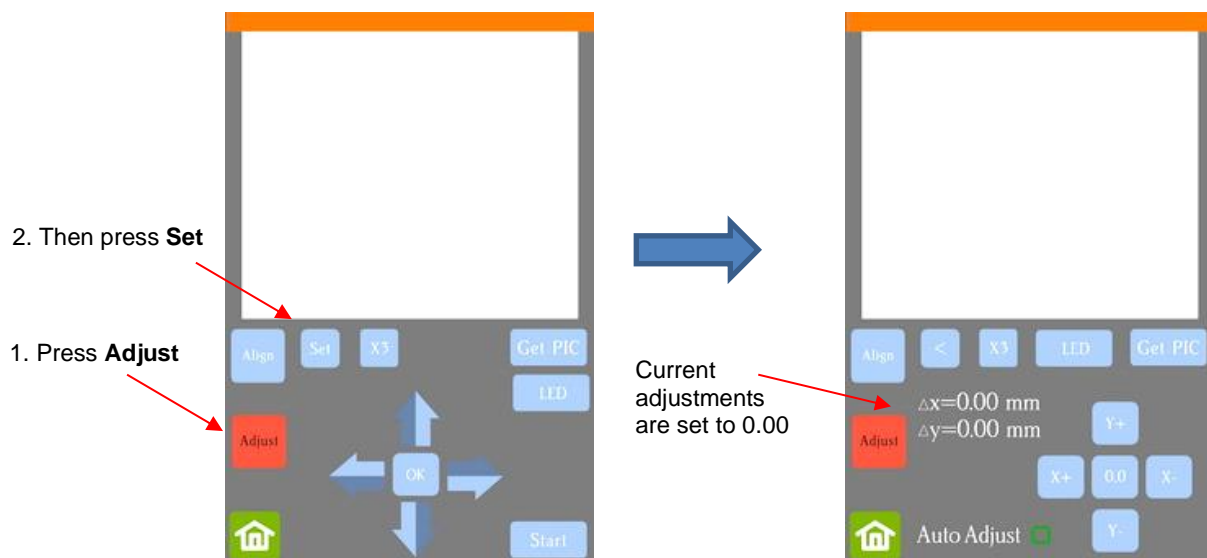

- One at a time, adjust Δx and Δy by pressing the buttons in the direction you need the cut line to move.

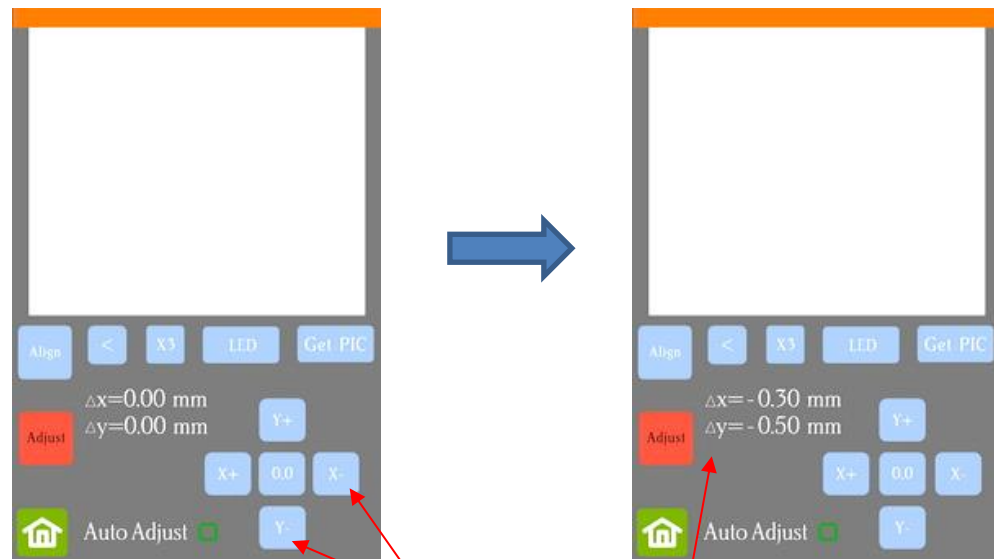

Click on these buttons until Δx and Δy match the needed adjustments

- Once the values are set, press the **Home** button to return to the **Main Screen**. Test again to verify the cut line is better aligned with the printed shape.
- **Important:** You can also adjust calibration numbers after a cut has begun! These adjustments will only apply for this particular cut but can be very useful in “saving a cut.” Refer to second part of *Section 3.07.3* for instructions.

3.05.2 Inaccurate Tracings

- When tracing imported bitmap images, the resulting cut lines may not necessarily follow the original image, especially in tight spots. This can result in tiny bits of white appearing, suggesting the PNC wasn’t accurate. Zoom in on the image so that you can see the trace line following the outline of the image. Compare by looking at the same spots where the cut didn’t follow the image perfectly. This could be the cause of the inaccurate PNC. There are several ways of handling this situation:
 - ◇ Retrace the imported image using a lower **Tolerance** setting. This should result in a tighter fit around the original graphic. Refer to *Section 5.01*.
 - ◇ Use the **Node Edit** tool  to move the trace lines, where needed, to more closely fit the original graphic. Refer to *Section 5.02*.
 - ◇ Create an inset contour cut line to use for cutting instead of the original trace line.
- Another possibility is that the contour cut line was inadvertently shifted from the graphic to be printed. So, check to see if a misalignment may have occurred when you were moving or simply clicking on the design.

3.05.3 Incorrect Cut Settings

- If a PNC is not precise and the cause is not the calibration nor the alignment of the trace lines, then go through the following check list of other possible causes:
 - ◇ Try slowing down the speed. If the mat is moving numerous times, in and out of the cutter, a slight shifting can occur, especially at high speeds. On the Skycut, try a speed of 6 or lower.
 - ◇ Verify that the pinch wheels are still centered over grit shafts beneath. Even if one of the wheels is half on / half off a grit shaft, it can cause the mat or material to skew slightly.

- ◇ Make sure the blade isn't over-extended which can cause it to cut too deeply and drag the cutting mat.
- ◇ Make sure the bottom of the mat isn't sticky and the pinch wheels and grit shafts are clean and not sticky. Clean with a lint-free cloth and a small amount of isopropyl alcohol or Un-Du applied to the cloth.
- ◇ If the print and cut project contains a lot of shapes or the material is thick, try intermediate registration marks so that additional scans can occur during the cut. Refer to *Section 3.06.2* for instructions.

3.06 Contour Cutting Multiple Images and Adding Intermediate Registration Marks

- Using intermediate registration marks allows for additional scanning during a contour cut which can compensate for any drifting that can occur as a result of friction. This is typically only needed when the printouts are very large or the material being cut is thicker or denser than vinyl, paper, or cardstock.
- Because SignCut Draw does not currently support more than one raster image within a single project file, it is necessary to use an alternative program for preparing these kinds of projects. In this tutorial, [Inkscape](#) will be used. However, a similar process can be used in other graphic programs, such as Adobe Illustrator, Photoshop, Affinity Photo, Corel Draw, etc.

3.06.1 Setting Up Multiple Raster Images in Another Program

- Download a registration mark file from [this link](#). If you want to experiment with the scanning of intermediate registration marks, select either of those templates. Note that these are SVG files, not SCD like the ones you downloaded in *Section 3.04.2*.
- Because SVG is a native file format for Inkscape, use **File>Open** to import the shapes into a new Inkscape file. Other graphic programs will most likely use **File>Import**. The sole purpose of having the registration mark file present is for arranging the images you plan to print and cut, as explained in the next step.

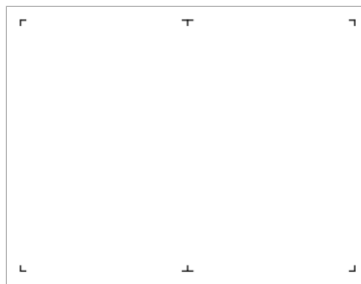

- Use **File>Import** to open the raster images you want to use in your project. Arrange the images so that they are not overlapping the boundary defined by the registration marks. Use the bounding box which appears around a selected shape for guidance. Note that allowances should also be made for the size of the contour cut:

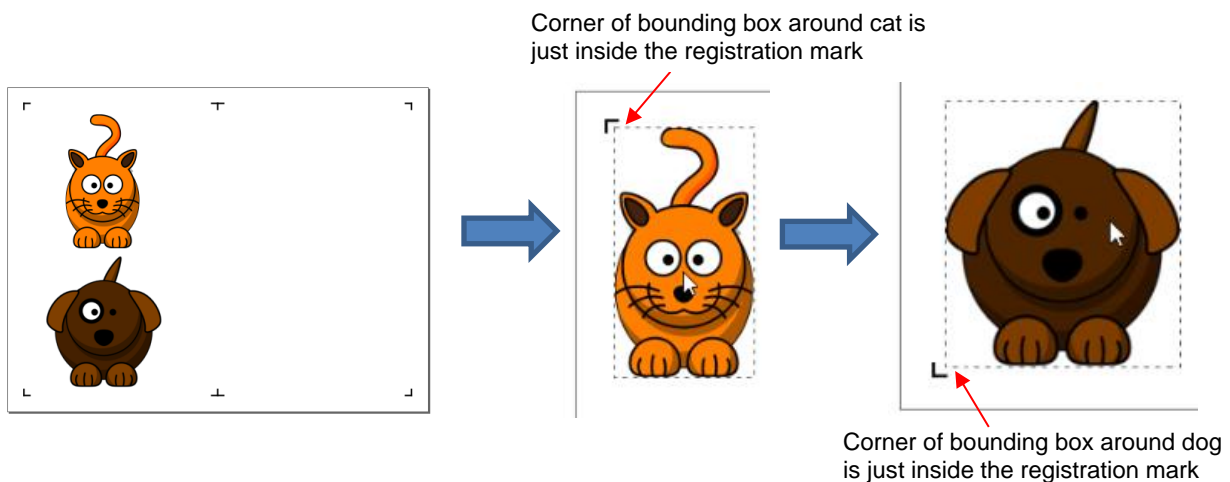

- Make duplicates of the imported shapes, as needed. Remember that if an image is too close to a registration mark, the camera may confuse the two:

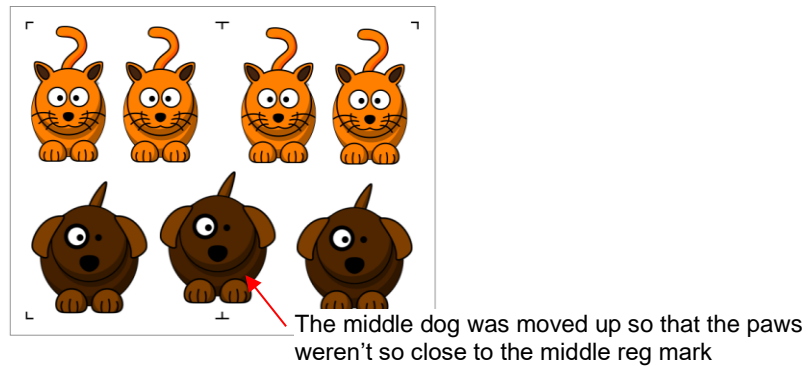

- Delete the registration marks. Select all of the images and note the dimensions of the project, if you need the image to be the same size in SignCut Draw:

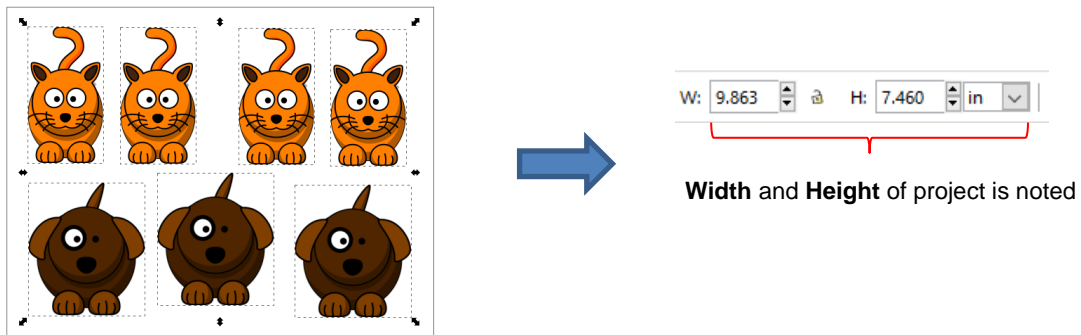

- Export the project from Inkscape as a raster file (PNG or JPG) to import into SignCut Draw.

3.06.2 Using Intermediate Registration Marks

- In SignCut Draw, open the [registration mark SCD file](#) with the same name as the SVG file used in Inkscape:

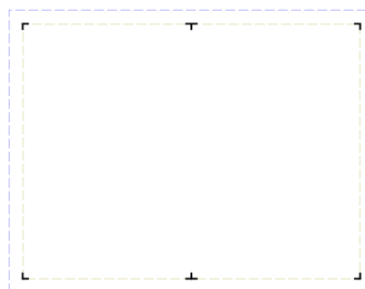

- Import the raster file exported from Inkscape using the **Import bitmap file** icon . Select the second option to **Adjust bitmap size to current sign size**:

Select this option →

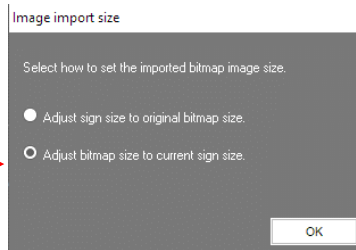

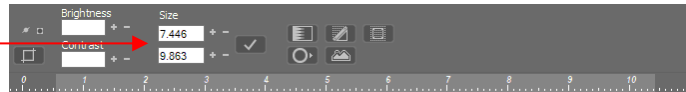

- Select the bitmap image and enter the dimensions to match those in Inkscape (if that is a requirement). Drag the project, as needed, to re-center in the **Sign Area**:

Dimensions changed →

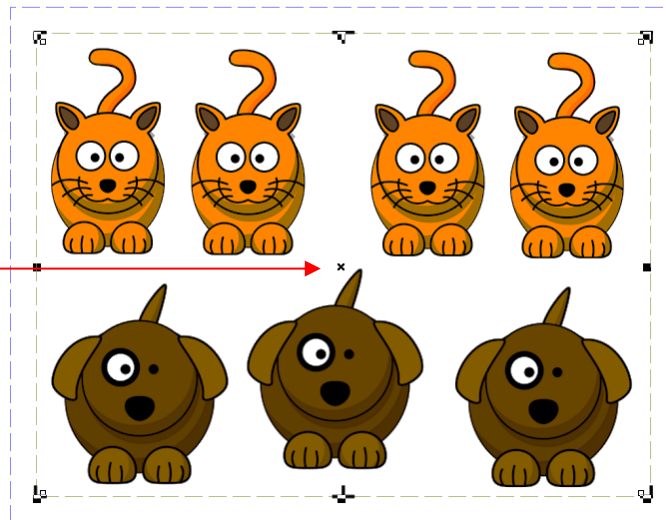

Drag project, if needed →



- Before adding the contour lines, click on the **Select/deselect all layers** icon  at the bottom of the **Filter Colors and Objects Panel** until the registration marks are no longer visible (or appear as dashed lines). Alternatively, hold the **Shift** key and left click on the black square. By deactivating the color black, contour lines won't be placed around the registration marks:

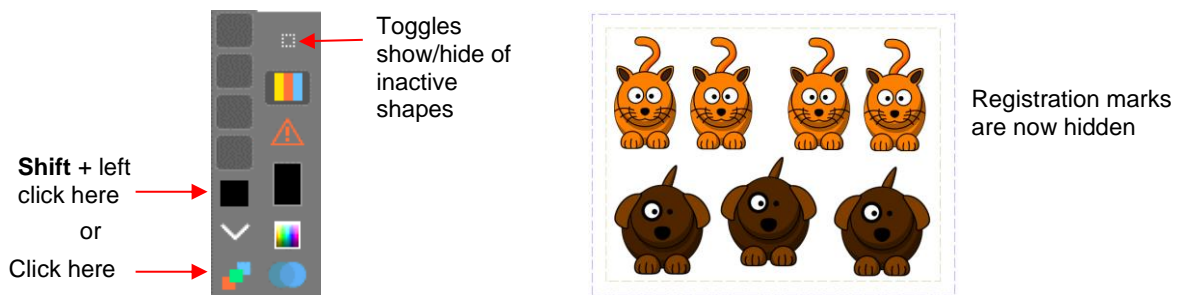

- With the reg marks inactive, use the **Create outline on bitmap** icon  to add contour cut lines around the images. This is covered in *Section 5.01.2*:

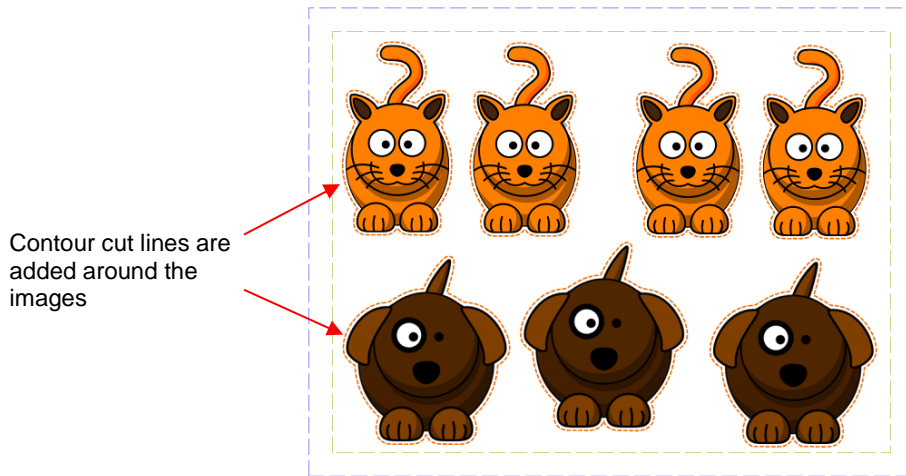

- Return to **Object edit** mode  and restore the registration marks. The project should now appear like this:

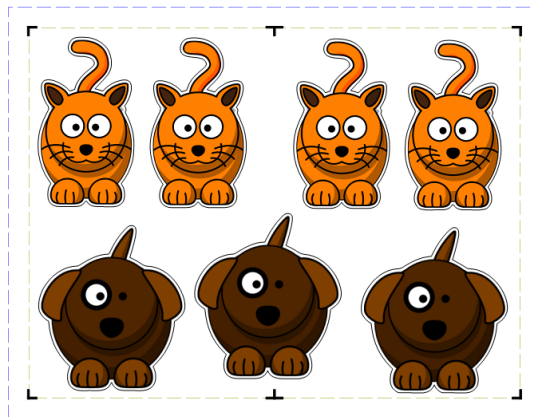

- Proceed with the printing and the cutting processes, as presented in *Section 3.04*. The Skycut's camera will scan the following reg marks first and cut only the shapes which are located in that segment.

The Skycut will scan these 4 reg marks first

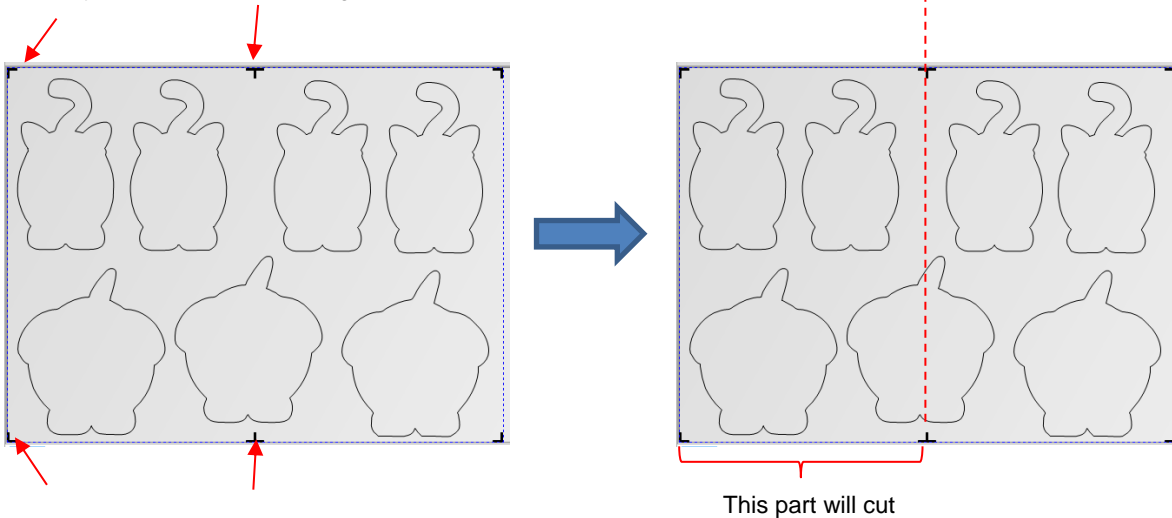

- The Skycut will then scan and cut the second segment:

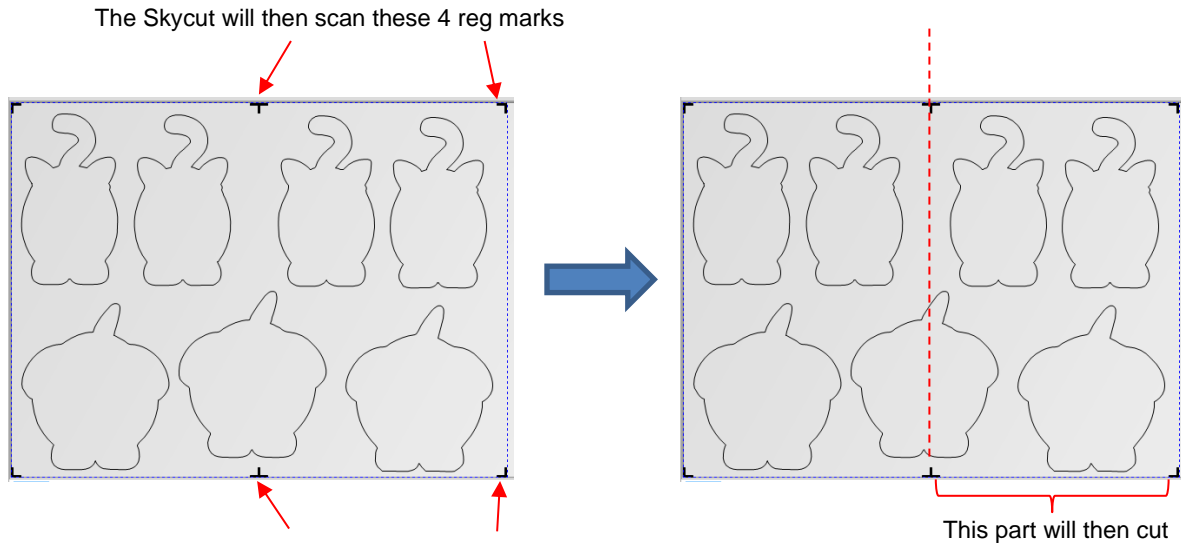

- If additional registration marks are desired, copy and paste the middle set and relocate to desired locations. Note that they do not have to be equally spaced with respect to the others, but do need to be in alignment:

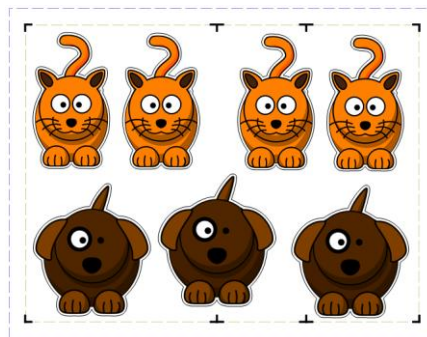

3.06.3 Automatically Adding Intermediate Registration Marks in SignCut Draw

- In *Section 3.04.2*, it was shown in *Option B* how to add registration marks without opening a template. Intermediate registration marks can be added in a similar way. However, at this time, these registration marks are not recognized as such in SignCut Pro.
- In this tutorial, a large number of repeats are going to be printed and cut. Adding intermediate registration marks ensures greater accuracy through the progression of the cut.



- Adding intermediate registration marks ensures greater accuracy through the progression of the cut. In this project, it is decided to add marks ~ every 4 inches.

- To add the registration marks, click on the **Sign setup** icon  on the **Tools Panel** (or press the shortcut **W**). Mark the **Reg marks** option. The following appears on the **Properties & Functions Bar**:

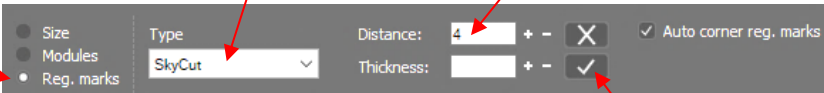

1. Select **Reg marks**

2. Select **Skycut** from the **Type** menu

3. Change the **Distance** to the desired spacing

4. Click on **Apply**

- Select Skycut from the **Type** menu. Entering the spacing (in this example, 4 inches) into the **Distance** field. Click on **Apply**:



- Intermediate registration marks are added to the project. Note that while the marks appear as red outlines, they will print solid black.
- There is an option to hide the marks on the screen by toggling the **View registration marks** option on the **View Bar**:





- IMPORTANT:** Using the **Array** plus **Array Mark** options on the SkyCut's control panel allows for more flexibility when working with multiple registration marks, such as being able to only scan one mark when there are repeats. This is covered in *Section 3.07.2*.

3.07 PNC from USB Flash Drive

3.07.1 PNC from Flash Drive – Single Cut

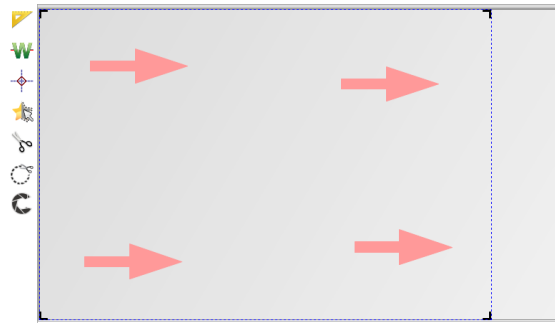
- To perform a print and cut project from the control panel, first perform *Steps (1) – (7)* from *Section 3.04.3*. The project will now appear in SignCut Pro:



- Hold the **Shift** key and left click on the **Contour cut** icon . This will open the **Save as** window where you can save the job as a PLT file on a USB flash drive inserted into a port on your computer:

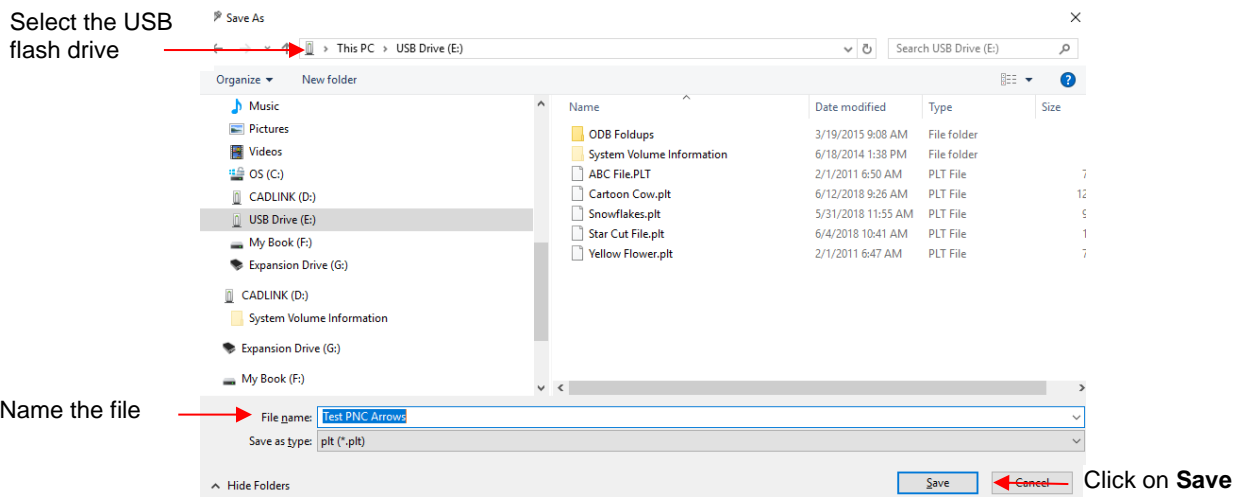

- On the Skycut's control panel, set the **Force** and **Speed**, if you elected not to have them activated on the **Tool Settings** tab in SignCut Pro.
- Go to **Set>Camera**. With **Align** selected, press **Set** and the following window will open:

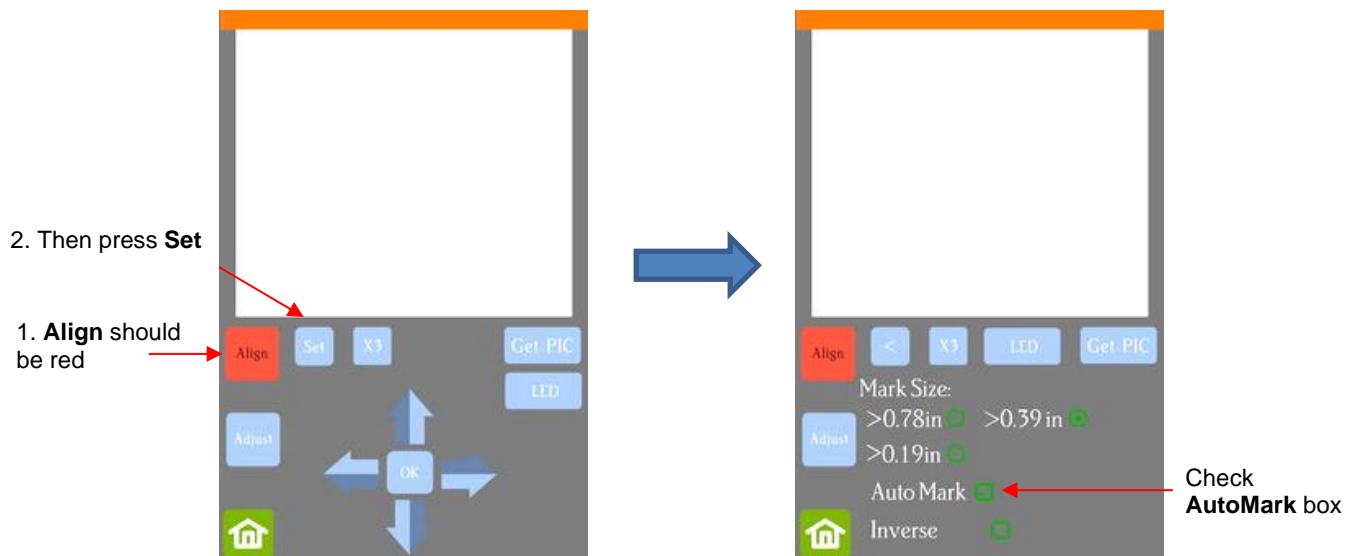

◇ Verify that **AutoMark** box is checked. Then click on **Home**.

- Insert the flash drive into the right side of the Skycut and use the instructions in *Section 1.12.4* to open the file into the Skycut:

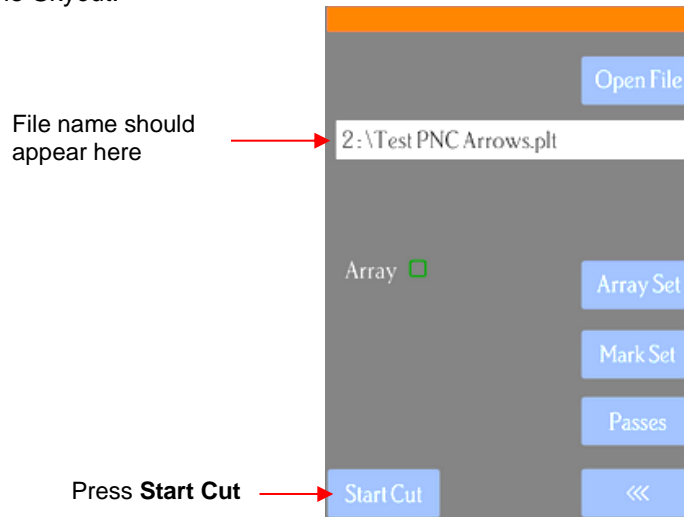

- Click on **Start Cut** and the marks will be scanned by the camera and the shapes cut out.

3.07.2 PNC from Flash Drive – Using Array Mark for Repeats

- The Skycut has the ability to set up an array of repeats for PNC applications. The advantage to using the Skycut's control panel for this process is that the **Array Mark** function permits the scanning of additional registration marks as repeats are cut. This is far more accurate than only scanning the original four marks on significantly large projects:

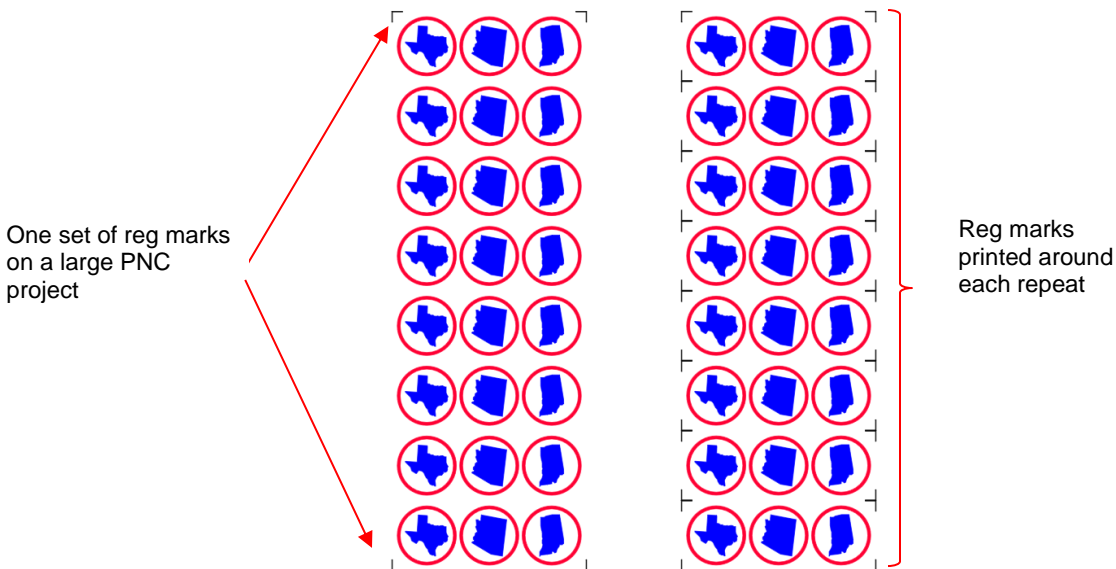

- The **Array Mark** window on the control panel can be opened in two ways:
 - Go to **Set>Advanced Settings>Array>Array mark**
 - Go to **USB>Array Set>Array mark**
- In the **Array Mark** window, you have three options:
 - **4 Mark:** Scan all four marks on every repeat

The number of marks	
4 Mark	✓
1 Mark	
Alternate	

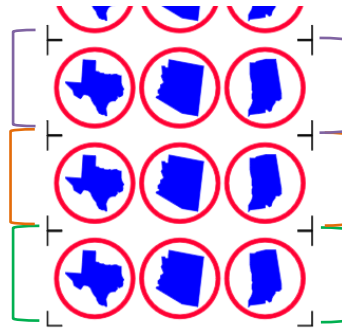

1. Four marks in **green set** are scanned first and first three shapes cut.
 2. Four marks in **orange set** scanned, next three shapes cut.
 3. Four marks in **purple set** scanned, next three shapes cut.
- etc.

- **1 Mark:** Scan first four marks on first set only. Then scan one mark only on each remaining repeat

The number of marks	
4 Mark	
1 Mark	✓
Alternate	

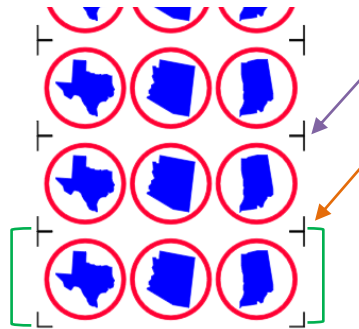

1. Four marks in **green set** are scanned first and first three shapes cut.
 2. Single mark by **orange arrow** scanned, next three shapes cut.
 3. Single mark by **purple arrow** scanned, next three shapes cut.
- etc.

- **Alternate:**

Combination of **4 Mark** and **1 Mark** options

The number of marks	
4 Mark	
1 Mark	
Alternate	✓
changing interval:	
-	2
+	default

Alternate between scanning all 4 marks and scanning only 1 mark, based on a set **Interval**

Interval set to 1:

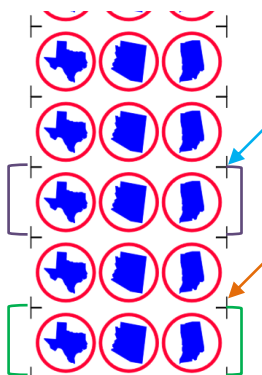

1. Marks in **green set** scanned and first three shapes cut.
 2. Single mark by the **orange arrow** scanned, next three shapes cut.
 3. Marks in **purple set** scanned, next three shapes cut.
 4. Single mark by **blue arrow** scanned, next three shapes cut.
- etc.

Interval set to 2

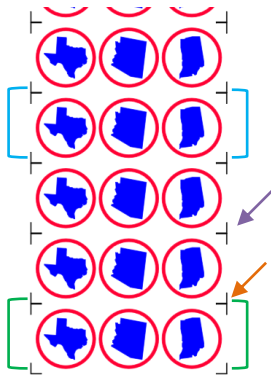

1. Marks in **green set** scanned and first three shapes cut.
 2. Single mark by **orange arrow** scanned, next three shapes cut.
 3. Single mark by **purple arrow** scanned, next three shapes cut.
 4. Marks in **blue set** scanned, next three shapes cut.
- etc.

- When choosing an **Array Mark** option, keep the following in mind:
 - The purpose of having intermediate scans is to correct for any slippage that occurs due to friction or excessively fast cutting speed.
 - Use **4 Mark** in situations where the repeats are quite large, thus there's a larger distance between the repeats and slippage is more likely to occur. It's also a good option when cutting thicker materials because the higher force applied by the blade can cause more drag on the material or cutting mat.
 - Use **1 Mark** in situations where the material is thin, the cuts are simple, and the distance between the repeats is relatively small. Obviously, this is the most time-efficient choice of the three options since a 4 mark scan is only performed one time.
 - Use **Alternate** as a compromise between the other two options. Experience will determine how high of an **Interval** can still yield the accuracy you need.

3.07.3 Mark Set Options

- The **Mark Set** window has the following two applications:
 - ◇ Select a specific range of images to cut versus the entire project file.
 - ◇ While the cutting is underway, if you observe that the accuracy is off, you can immediately pause the cutter and tweak the calibration for just that particular cut.
- To select a specific range of images, note the following:
 - ◇ The first set to cut is referred to as **M0** and then subsequent sets are **M1, M3, M3**, etc.
 - ◇ In the **Mark Set** window, select **Custom** and then enter the start and ending sets. For example, if you want to start with the second set and end with the seventh, you would change to **M2** and **M7**:

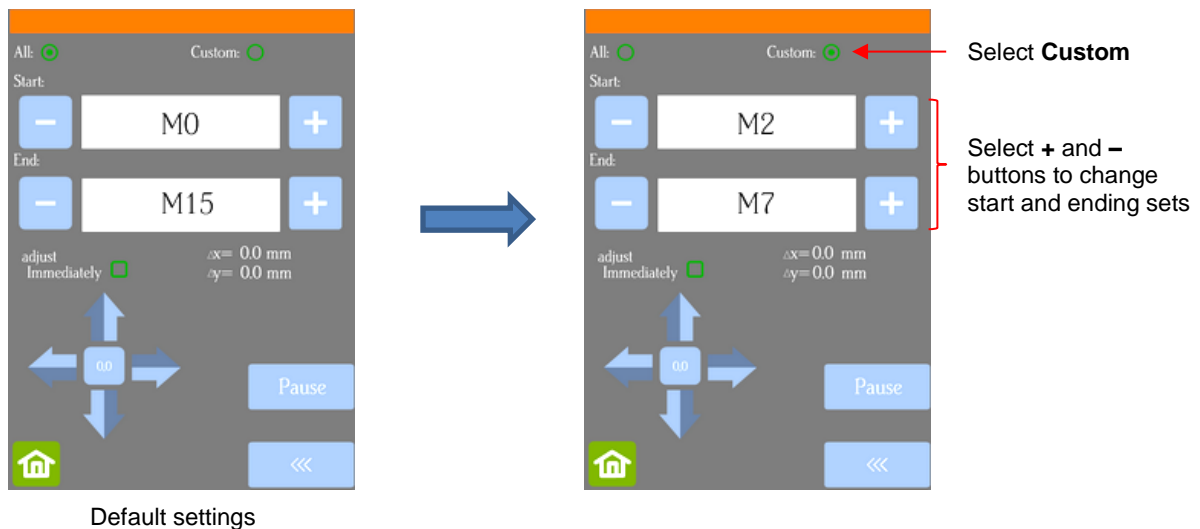

◇ The resulting sets will be sent versus the entire project:

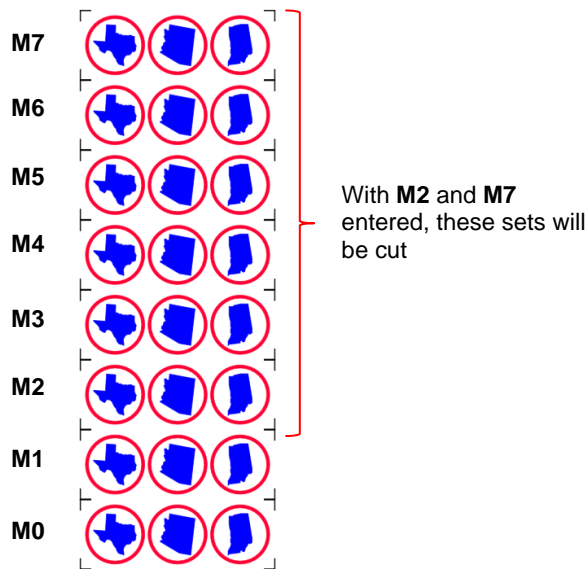

- To tweak the calibration after a cut has begun:
 - ◇ Press the **Pause** button on the **Home** screen to immediately stop the cutting.
 - ◇ Press the **USB** button on the **Home** screen.
 - ◇ Press the **Mark Set** button.
 - ◇ Check or uncheck the **adjust Immediately** option based on the following:
 - Check the option if you want the adjustment to be made on the current shape that was being cut when you paused the Skycut. Note that the start and end point on that path will not completely close, as a result.
 - Do not check the option if you want the adjustment to be applied on the next shape that will be cut.
 - ◇ Click on the arrow buttons to adjust the Δx and Δy by the amount and in the direction you need the cut line to move:

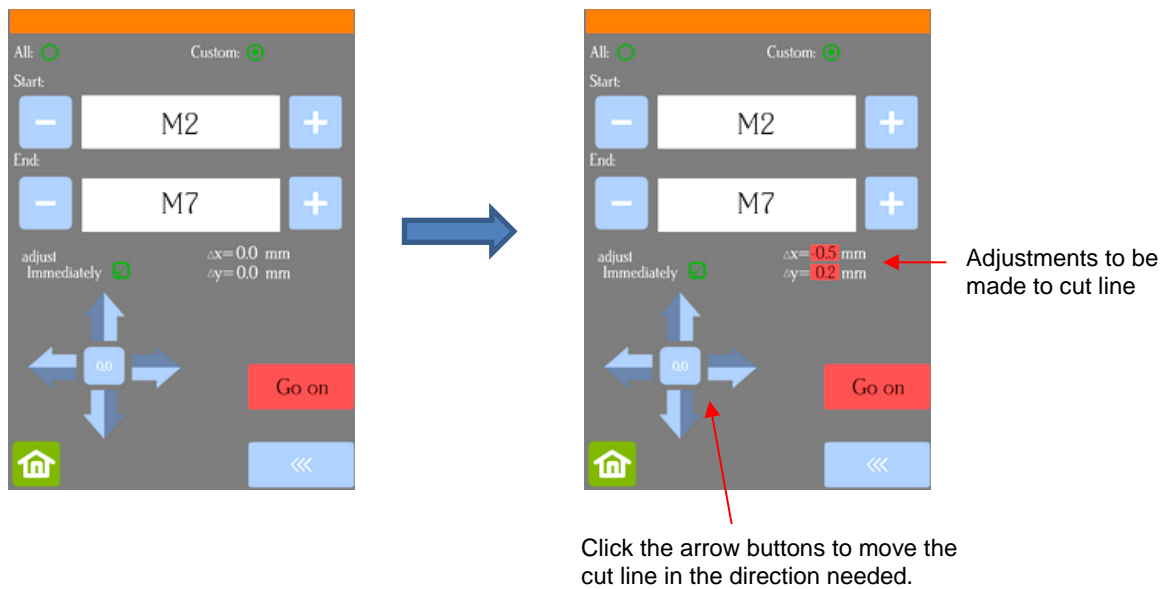

- ◇ Once you have entered the Δx and Δy values you wish to use, press the **Go on** button and the cutting will resume.

- **Important:**

- ◇ If you need to make yet another adjustment, repeat the process. The new Δx and Δy you enter is only an adjustment based on what you are now needing. For example, based on this example, if you need Y to move another 0.2 mm in the same direction, you would enter 0.2, not 0.4 mm.
- ◇ Remember that the adjustment is reset at the conclusion of the cut. If you want permanent changes, adjust the calibration numbers using the process presented in *Section 3.05.1*.

4. Accessory Tools and Dual Head Calibration

4.00 Quick Reference for Chapter 4

- How to calibrate an accessory tool with the blade holder or other tool: *Section 4.01*
- How to draw with the test pen and cut around the drawing: *Section 4.02.1*
- How to score and cut a fold-up project: *Section 4.02.2*
- How to emboss cardstock: *Section 4.02.3*
- How to engrave a metal tag: *Section 4.03.1*

4.01 Dual Head Calibration

- ***IMPORTANT:*** Before proceeding with any dual head applications, note the following setting which needs to be changed in SignCut Pro2 in order for the right side to be used when assign Tool2 with any particular color of shapes:
 - ◇ In the **Cut out** window, on the **Cutting** tab, select **D24** from the **Choose cutter preset** menu:

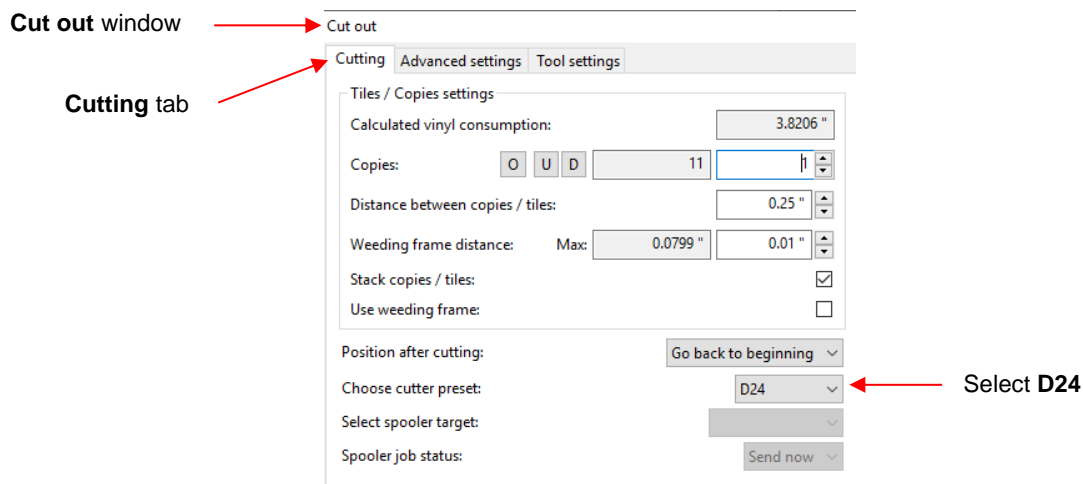

- In *Section 3.03*, the camera calibration was presented showing how to make sure the blade holder is calibrated with the camera. A similar calibration is also needed to make sure the right and left blade holder seats are perfectly aligned with one another. This then allows you to do accurate draw-and-cut, score-and-cut, engrave-and-cut, and other combined tool applications.
- (1) On the control panel's **Main Screen**, make sure the **Use Double Head** option is selected. If you do not see any of these options, click on **Set>Advanced settings>System mode** and select **double**. Then, back on the **Main Screen**, the options should now be available:

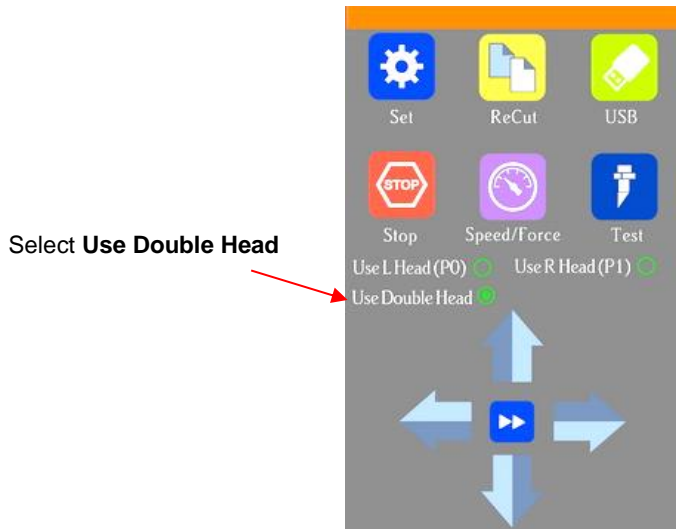

Select **Use Double Head**

- (2) Insert a sheet of paper into the Skycut, either on the cutting mat or directly inserted. Load a test pen into both the left and right side blade holder seats, making sure the pen nib is a little ways above the paper, as you did in *Section 1.13*. You can also use a stack of 35 Post It notes as presented in *Section 2.01.3*.
- (3) Select the **Speed/Force** function and make sure both sides are set to a suitable **Force** for drawing: ~ 30 – 40.
- (4) Make sure both pens are over the paper. On the **Main Screen**, select **Set>Camera** to open the camera calibration screen:

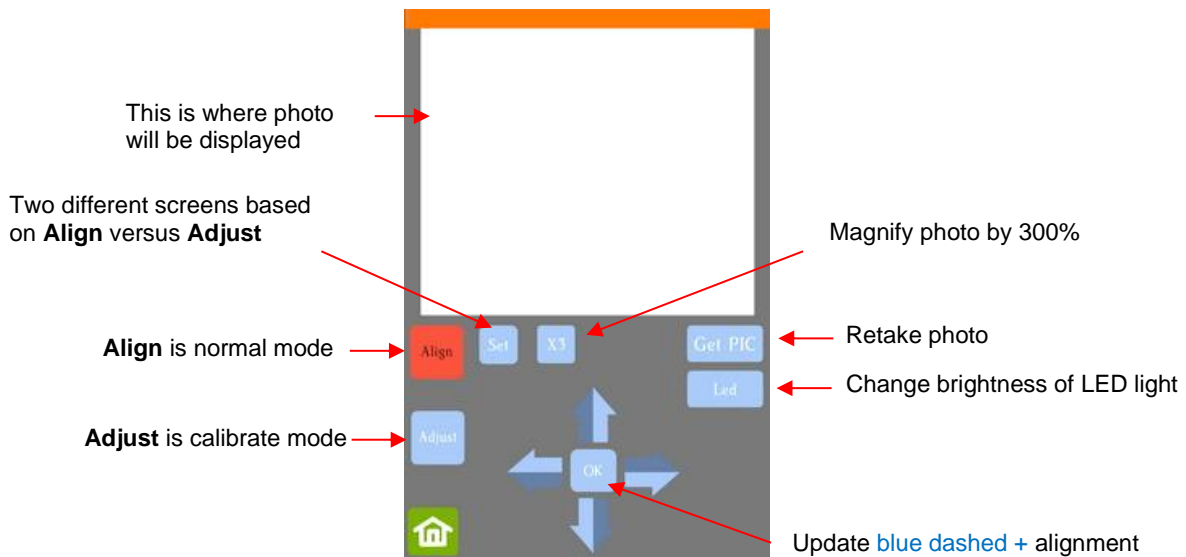

- (5) Press **Adjust** to switch to calibrate mode and a new **Start** button will appear in the lower right corner of the **Camera Screen**:

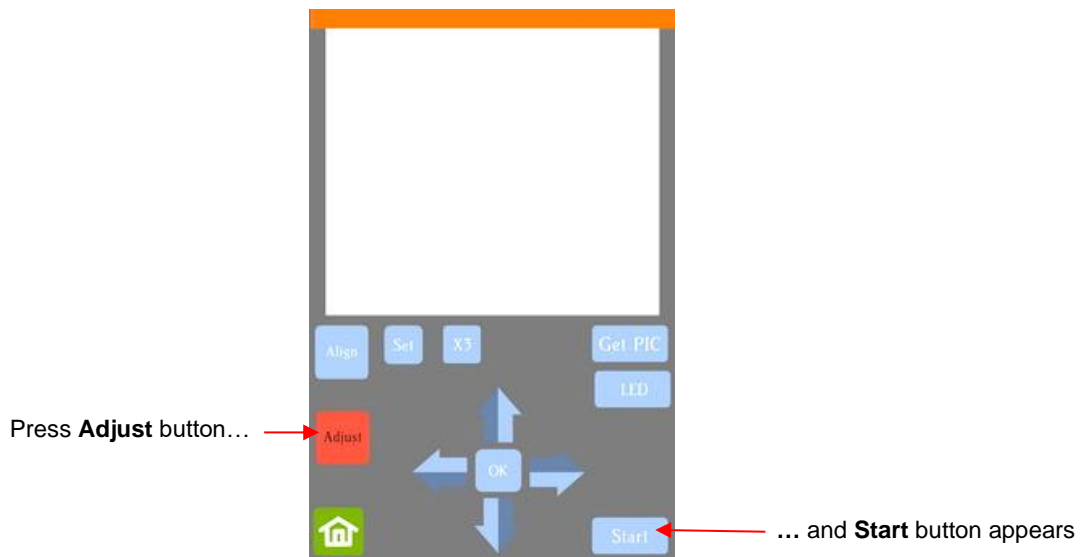

- (6) Press **Start**. A test shape, which is a square with a **+** inside, will be drawn by the right side pen on the paper and the camera will move over the test shape, take a photo, and display the photo on the control panel. If you cannot see the test shape clearly, press the LED button once so that it reads LED 50% and press the **Get PIC** button. You should see three items in the photo: the test shape that was drawn with the pen, a **red +**, and the **blue dashed +**:

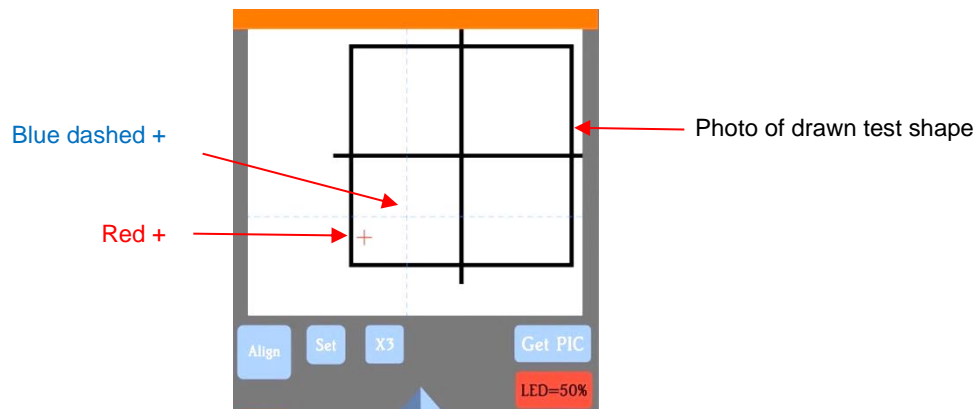

- (7) Tap your finger near the middle of the drawn test shape. This will move the **red +** to that location. Then press **OK**. A new photo will be taken:

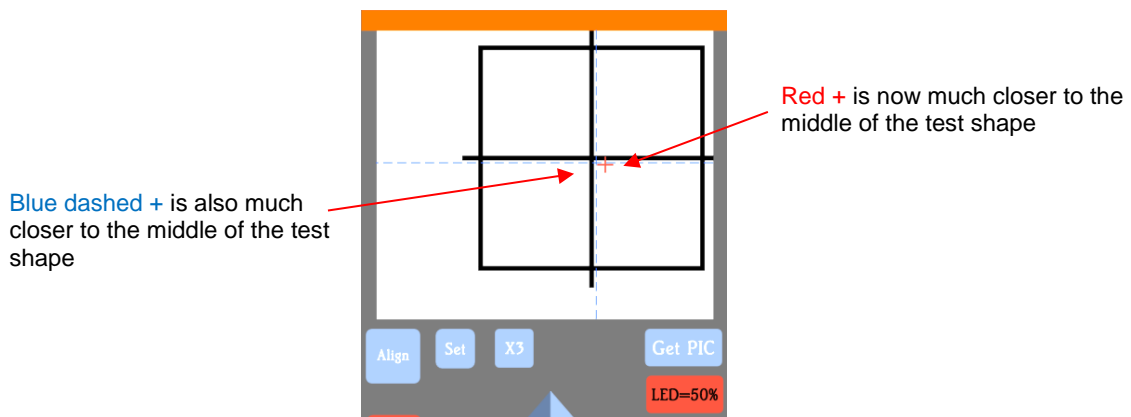

- (8) Press **X3** so that a magnified version appears:

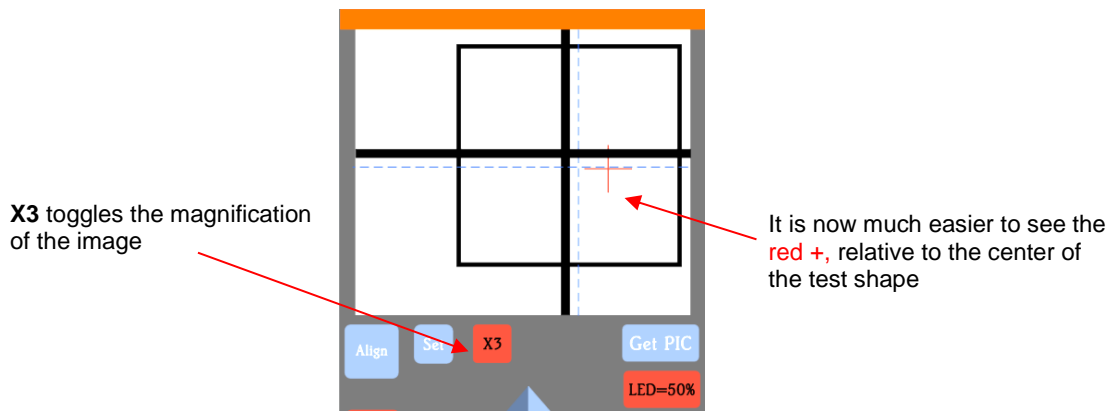

(9) Use the arrows keys to move the center of the **red +** to the center of the test shape:

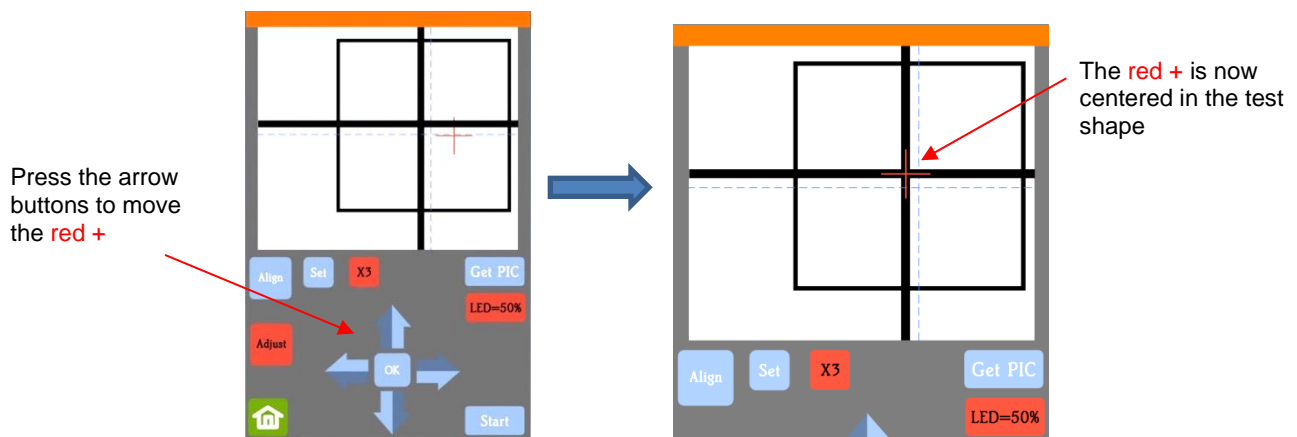

(10) Press **OK** and a new photo will be taken. The **blue dashed +** should now be more closely aligned with the center of the test shape:

IMPORTANT: the **red +** is intentionally moved away from the test shape with each new photo so that you can more easily see if the **blue dashed +** is centered.

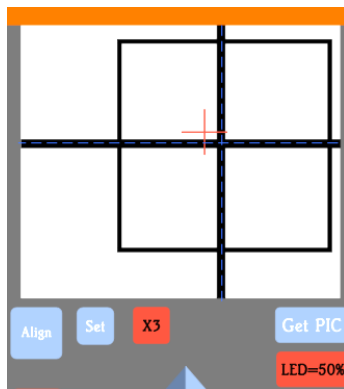

(11) If necessary, repeat *Steps (9) and (10)* until the **blue dashed +** is near-perfectly centered in the test shape.

(12) Now move the **red +** so that it is perfectly aligned with the center of the **blue dashed +**:

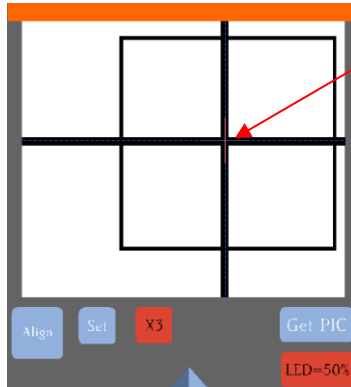

Move red + to align with center of blue dashed +

- (13) Press **OK** and the camera will move to the left side test square and will post an image. Repeat Steps (7) – (11).
- (14) Once the **blue dashed +** is near-perfectly centered in the test shape, click on the **Home** icon to return to the **Main Screen**. Your Skycut is now calibrated for dual head applications.

4.02 Drawing with the Test Pen

- With the Skycut, you can draw shapes and lettering with the test pen. If you wish to fill (i.e. color in) a shape, SignCut Draw offers a **Hatch Fill** function. Refer to *Section 5.03* for instructions on how to adjust settings to create a line fill.
- Do not have the pen positioned too low in the blade holder seat or the tip of the pen could drag across the paper when moving from one shape to the next. Thus, use the same 35 Post-It note method as with the blade holder.
- Make sure your shapes will not be drawn where any of the pinch wheels travel over the material. Otherwise, the ink might smear.

4.02.1 Draw and Cut

- A draw-and-cut application involves using a pen to draw shapes and using the blade holder to cut them out... all in the same process. This rest of this section covers the process.
- In the [following example](#), a vector flower file has been imported into SignCut Draw and sized for the project:



- To add a contour, select the **Effects** icon  on the **Tools Panel** or press the shortcut **A1**. Make the following changes on the **Properties & Functions Bar**:

Mark the **Contour** option

Outside should be selected

Mark **Keep original**

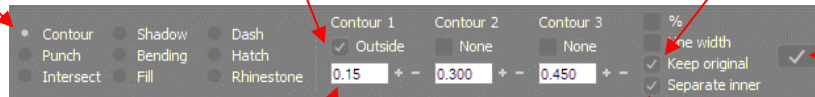

Enter **Contour size**

Mark **Separate Inner**

Click on **Apply**

- The flower now has a contour path around it. However, the **Select by color** panel indicates there are three colors present:



- The white shapes are the separate internal contour paths that were also created. To better illustrate their presence for this tutorial, they are recolored green:



- Since these internal paths won't be cut, select and delete them leaving the colors red and grey.
- Send the project to *SignCut Pro* and go to the **Cut out** window and click on the **Advanced settings** tab. The two colors will appear in the list and will be processed in the order shown. Because it makes more sense to draw first and cut second, the grey layer will be moved down. This is done by selecting the grey layer and clicking on the down arrow as shown:

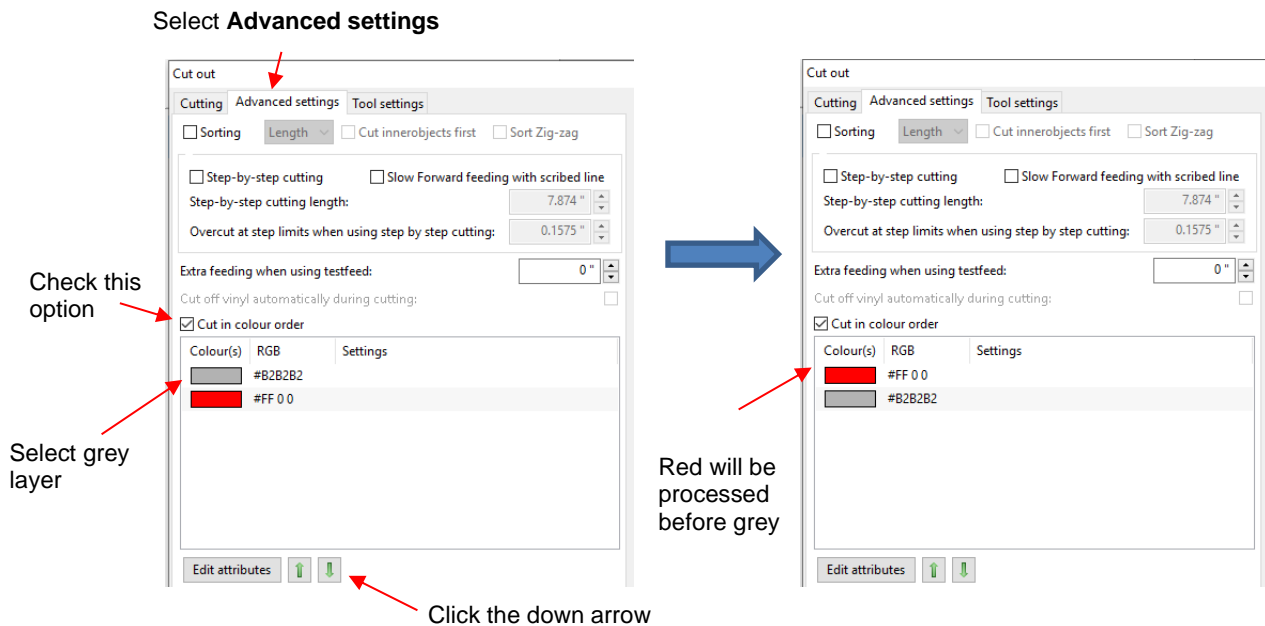

- Normally when cutting different colors, you would proceed to click on **Edit attributes** (at the bottom of the prior screenshot) for each color and enter the required **Cutting force**, **Cutting speed**, etc. However, because a pen doesn't require a **Blade Offset** setting, but the blade does, it is necessary to create presets for each color that will then be assigned to the red layer that will be drawn by the pen and the grey layer that will be cut with the blade. Refer to *Section 2.04.1*

- With the presets added, separately select each color and click on **Edit attributes**. Select the preset for that layer. Change the **Tool** setting to **Tool 2** for the red layer so that the right side will be used instead of the left (which is **Tool 1**). Note that assigning **Tool 2** could have been done when creating the preset.

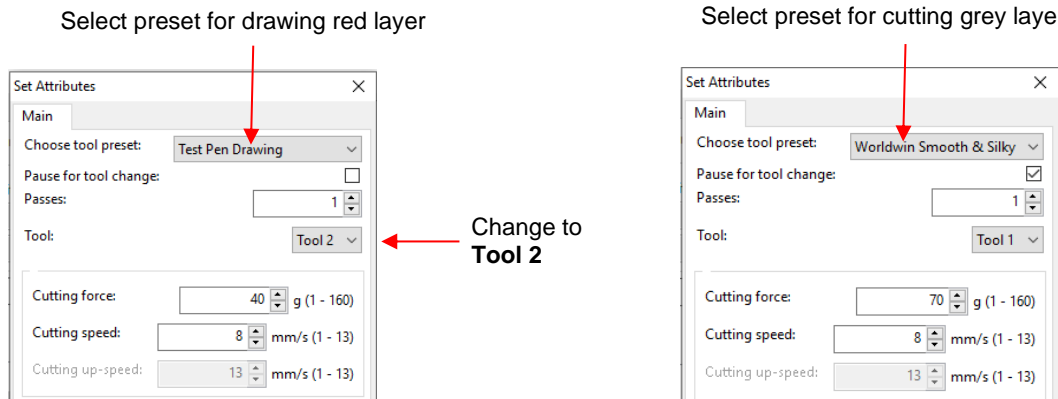

- Mount the blade holder on the left side of the Skycut D and the test pen on the right side. Load the cutting mat into the Skycut and set the origin based on the left side blade holder (or use the camera method presented in *Section 2.05.1*). Click on **Cut out** and the Skycut will draw the design with the test pen and cut it out with the blade holder.

4.02 Embossing and Scoring

4.02.1 General Info on Embossing

- The Skycut embossing tool has two different sized embossing heads. The smaller one is recommended when scoring cardstock for fold-up projects, such as pop-up cards, gift bags, and small boxes. Either head can be used for embossing shapes.



- When embossing cardstock, it is recommended that a soft material be placed beneath the paper or cardstock to allow a deeper impression to be made. One excellent material to use is non-slip shelf liner. Other materials which can be used include rhinestone rubber, craft foam, and felt. Make sure the material is well adhered to the mat (tape it down, if necessary). Then tape your paper or cardstock to the top of this material.
- When using the embossing tool for scoring fold-up projects, the paper or cardstock can be applied directly to the mat, just as you do for cutting. This makes it much simpler when you need to score and then immediately cut. Because the scoring may not be as deep on the underside of the paper or cardstock as the top side, fold all score lines (valley and mountain) forward to establish the fold on both sides. Then flip over and fold any mountain folds the opposite way. This especially works well on pop-up cards.
- Make sure you do some tests first to get the best settings for the scoring or embossing. For scoring cardstock, this typically involves a higher force (~160) and two or three passes. Refer to the *Suggested Settings* table at the end of this chapter. If you have a soft material beneath your paper/cardstock, then a lower force will be used, but you may still need several passes. Also, to get more force applied, raise the tool in the blade holder seat the same way you do with the blade holder (i.e. 20 Post-It notes).

4.02.2 Score and Cut Project

- When a project involves both scoring and cutting, the same process presented in *Section 4.02.1* is followed. For testing, try out this foldup box which can be downloaded [here](#).

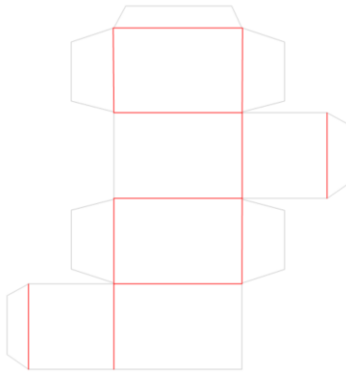

- As with a draw-and-cut application, the score lines should be a different color from the cut lines. Note that because the two rectangle scores are closed shapes, they are listed separately on the **Select by color** panel and will be treated as separate colors when assigning the settings in SignCut Pro:

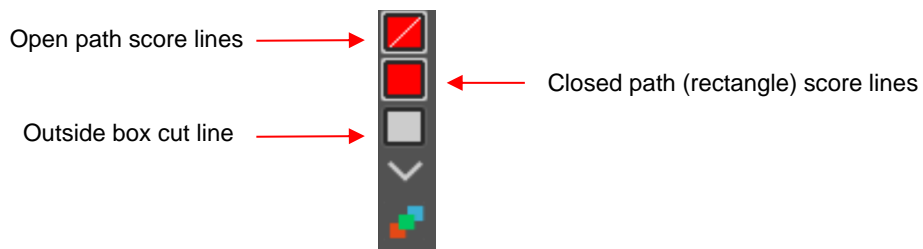

- After sending the project to SignCut Pro, open the **Cut out** window and note the following steps which were used in the *Draw and Cut tutorial*:
 - ◇ On the **Tool settings** tab, create separate presets for the scoring and cutting steps making sure the **Blade Offset** is set to 0 for the scoring tool. You may wish to also assign the scoring tool preset to **Tool 2** so that the right side will be used without needing to remember to change it in the **Edit Attributes** window. Refer to *Section 2.04.1* for directions on creating presets.
 - ◇ On the **Advanced Settings** tab, mark the option for **Cut in colour order** and move the score layers above the cut layer.
 - ◇ For each layer, click on the **Edit attributes** tab and select the appropriate preset from the drop-down menu.
 - ◇ Mount the blade holder on the left side of the Skycut D and the test pen on the right side. Load the cutting mat into the Skycut and set the origin based on the left side blade holder (or use the camera method presented in *Section 2.05.1*). Click on **Cut out** and the Skycut will score the fold lines with the embossing tool and cut out the design with the blade holder.



4.02.3 Embossing Paper or Cardstock

- When embossing paper or cardstock, it is recommended that you use contours to create several very small outlines with a spacing of, say, 0.01" (0.25 mm). These tiny offset lines will then produce a slightly thicker overall outline of your shapes. This works better than line-filled embossing which can stress the cardstock and cause wrinkling. Here are the steps:
 - ◇ Create the shape you wish to emboss. In this example, the number 25 is used:

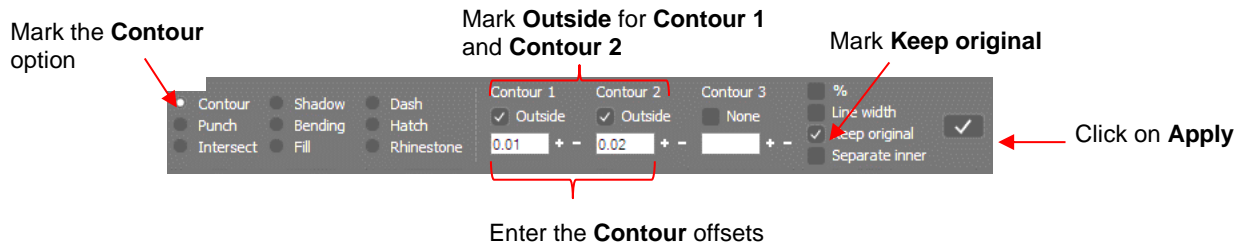

- ◇ Select the shape and click on the **Effects** icon  (shortcut **A**) and select the **Contour** option. On the **Properties & Functions Bar**, enter the settings for the two contours:



- ◇ Now you have three versions of the shape, each one slightly outset from the other. Thus, when using the embossing tool, this will result in a thicker outline made of this shape.
- ◇ **Important:** don't forget to mirror the image so that when you flip over the cardstock after embossing, the design will "read correctly." This can be done in one of two ways:
 - In SignCut Draw, click on the **Mirror horizontally** icon 
 - In SignCut Pro, click on the **Mirror image** icon 

4.03 Scratch Engraving

- The Skycut engraving tool can be used to engrave vellum, foils, acrylic, and most metals, including trophy labels, dog tags, and jewelry charms.



- On softer metals, you may not want the engraving tip too far above the metal as it can leave pock marks when it drops to start engraving. If possible, test on scraps first.
- Refer to the *Suggested Settings* table at the end of this chapter for **Force** and **Speed** settings on various materials. Note that in some cases you may want to use more than one pass for a slightly deeper engraving.
- To design an engraving fill pattern, use the instructions in *Section 5.03*.

4.03.1 Engraving a Metal Tag

Video

- When engraving items that are already cut (such as metal tags, trophy plates, charms, etc.), it's very important to have precise alignment before proceeding. Therefore, the camera on the Skycut will be used to set the origin for engraving. If you haven't already calibrated the camera, go to *Section 3.03*.
- The following is a list of the items you'll need for this kind of an application:
 - ◇ The item to be engraved
 - ◇ The Skycut engraving tool
 - ◇ Double sided tape to secure the item to the cutting mat. Thermo-web is perfect for this.
- Create a replica of the item to be engraved:
 - ◇ If it's something simple, like a square or a rectangle, use the basic shapes available in SignCut Pro:

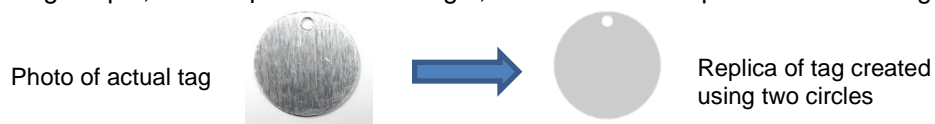

- ◇ If it's not a shape that can easily be recreated in SignCut Draw, then trace it onto paper:



- ◇ Scan or photograph the trace and use the instructions in *Section 5.01* to import the scan and create a contour of the heart:



Imported scan



Tracing from **Create outline on bitmap**

- ***IMPORTANT:*** Carefully measure the actual tag and compare it to the dimensions of the contour. Adjust the size of the contour if needed.
- Create the design to be engraved. In this case both text and a vector shape of a bone are added:



- Because a filled engraving is desired, select the text and the bone shape and use the **Hatch Fill** effect to fill the design with lines. Details on this function are presented in *Section 5.03.1*. The color of the outside tag is changed since it won't be sent to the Skycut:



- On the Skycut, the metal tag needs to be very firmly attached to the cutting mat. Place strips of double-sided tape onto the mat, where the tag will be mounted:

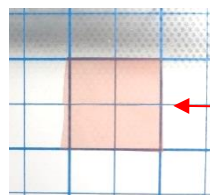

Double sided tape is placed on the mat to cover the size of the tag (note: the pink liner hasn't yet been removed from the top of the tape)

- When placing the tag onto the mat, align the bottom side of the tag with a vertical grid line and the left side of the tag with a horizontal grid line. The intersection of the two gridlines will be the origin for the engraving process:

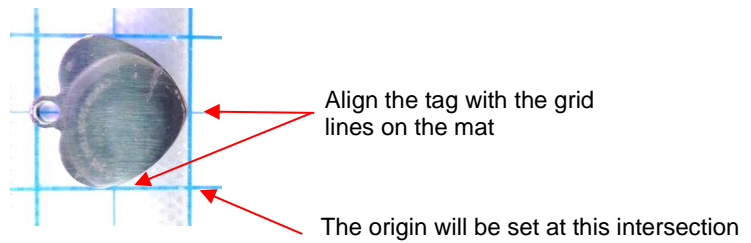

- Load the mat into the Skycut and be very precise in alignment by using the cutting strip to make sure the mat is perfectly straight on both sides:

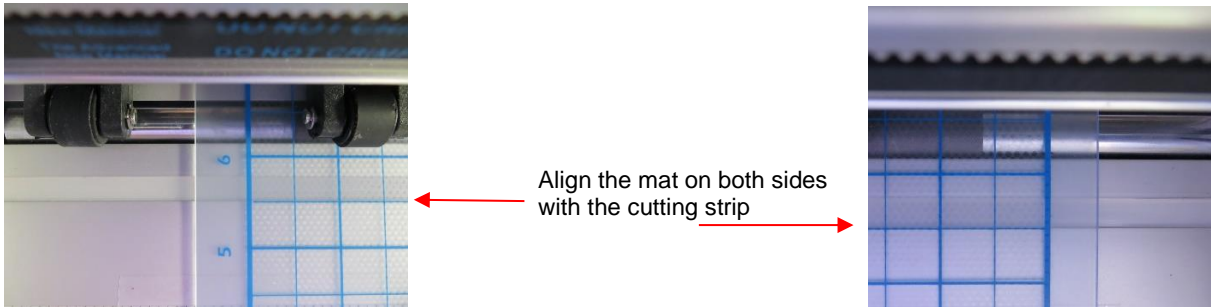

- Load the engraver into the Skycut using 15 Post-It notes, making sure the notes are on top of the tag so that the tip is clearly above the tag.
- Move the cutting head so that the engraver tip is over the intersection of the two grid lines bounding the tag. Then use the camera instructions in *Section 2.05.1* to set the origin even more precisely by getting the **blue dashed +** in the middle of the grid intersection:

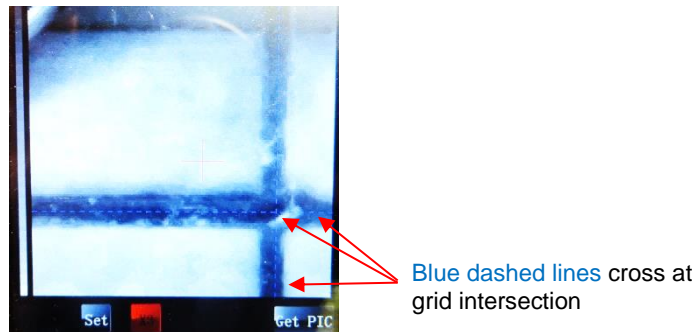

- After clicking on **Home**, press down on the engraver and verify, once more, that the correct grid intersection was used.
- Back in SignCut Draw, send the design to SignCut Pro. Note that it's very important to include the outside tag color since it defines where you want the engraving pattern to be made:

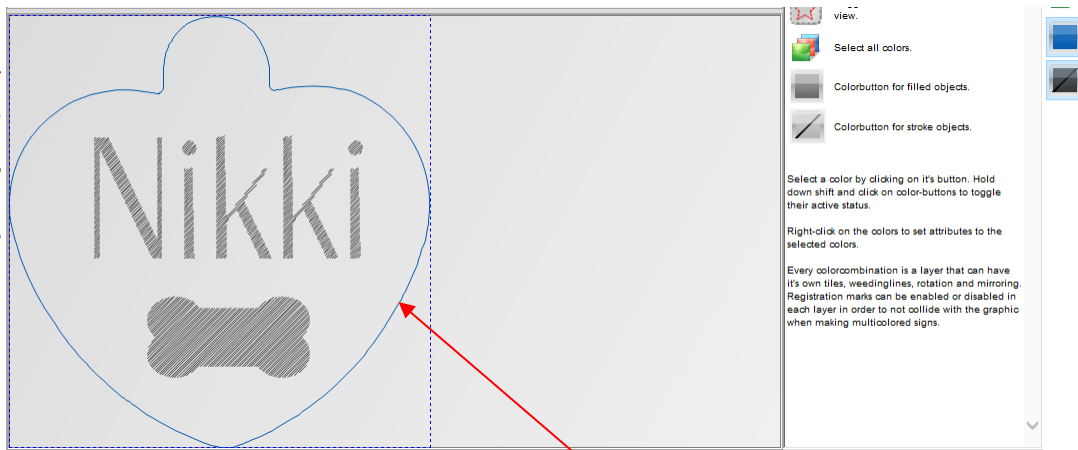

The heart tag shape needs to be present, even though it's not sent to the cutter

- Left click on the black color and the heart will no longer appear but the shapes to be engraved will retain their same position relative to the heart:

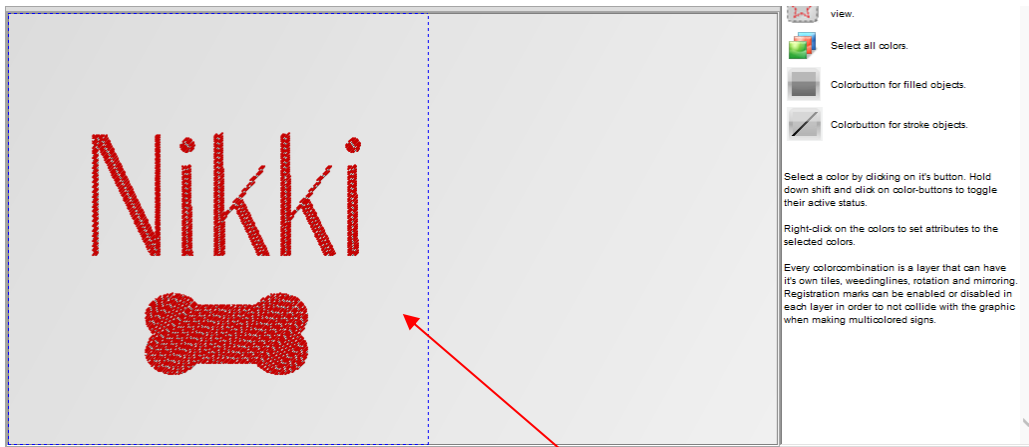

The shapes to be engraved have not changed position

Click on the black color so that it's the only one to be sent to the cutter

- Click on the **Cut out** icon and select the **Tool settings** tab. Note the engrave pattern shows the position and orientation relative to the origin you set on the Skycut:



- Enter the settings for engraving and create a preset, if desired:

Cut out

Cutting **Advanced settings** Tool settings

Name: Engraving Settings

Use software force and speed parameters

Cutting force: 44 g (1 - 160)

Cutting speed: 9 cm/s (1 - 13)

Override default pouncing values

Pounce down length: 0"

Pounce up length: 0"

Tool: Tool 1

Switch direction on open paths:

Passes: 1

Passes, registration marks: 1

Blade Offset: 0"

Overcut: 0"

Buttons: Cut out Testfeed Testcut

Annotations:

- Mark this option (points to the checked checkbox)
- Enter Force and Speed for engraving (bracketed around force and speed fields)
- Enter Passes (points to the Passes field)
- Leave these set to 0 (bracketed around Blade Offset and Overcut fields)
- Click on **Cut out** to start the engraving process (points to the Cut out button)

- After entering all settings, click on **Cut out** and the engraver will engrave the pattern onto the metal tag:



5. SignCut Draw Functions of Interest

5.00 Quick Reference for Chapter 5

- How to add a contour cut: *Section 5.01*
- How to edit a contour cut: *Section 5.02*
- How to fill a design with engraving lines: *Section 5.03*
- How to convert a photo into an engraving project: *Section 5.03.4*

5.01 Adding a Contour Cut Line to a Raster Image

- Graphics such as JPG, PNG, and BMP files are often used for print and cut (contour cut) applications. Because these types of files are raster images (versus vector images), the images must be traced. This is done through a process called vectorization.
- The **Bitmap tool**  (shortcut **I**) on the **Tools Panel** provides the necessary functions for importing a raster image and performing automatic tracing. When activated, the **Properties & Functions Bar** initially displays these options:



5.01.1 Importing an Image to Trace

- To begin the tracing process, click on the **Open bitmap file** icon  and an **Import** window will open. Browse to the folder containing the bitmap image you wish to open and trace:

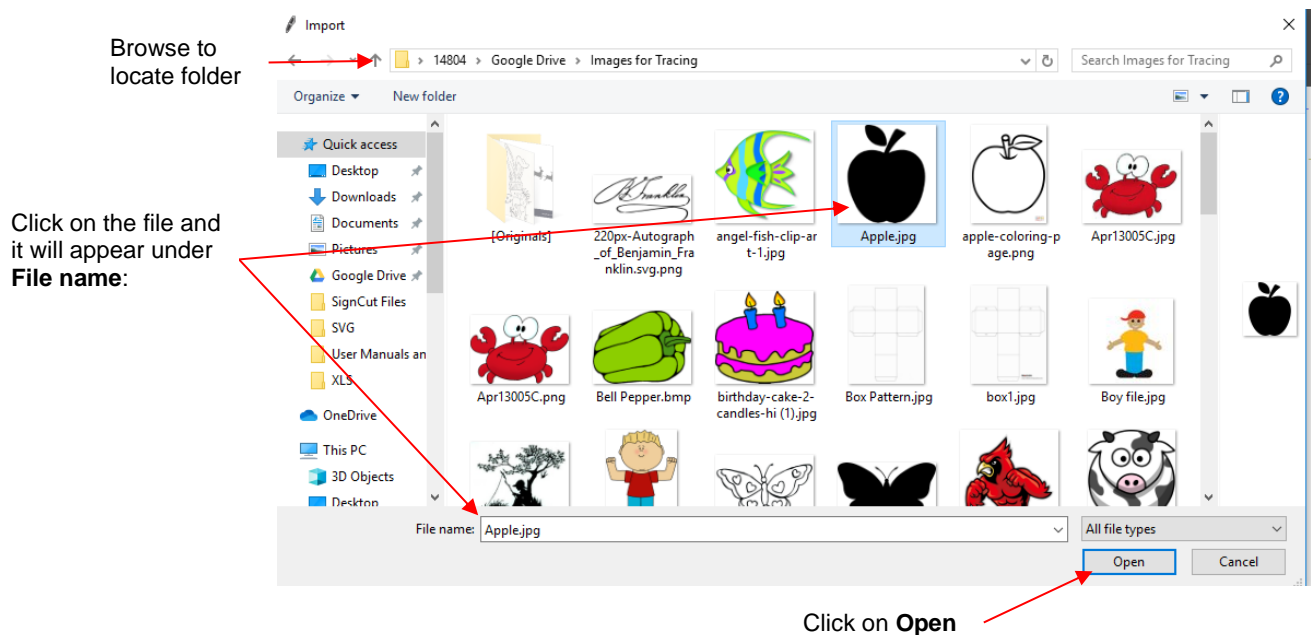

- If you tend to keep raster images in one particular folder, then holding the **Shift** key while clicking on the **Open bitmap file** icon will open a **Bitmap** window where you can set up a **Favorites** folder.
- Note that you can also copy/paste bitmap images from what's been copied onto the Windows clipboard (such as from Google images) into SignCut Draw.
- After selecting a file and clicking on **Open**, a popup window will provide two options:

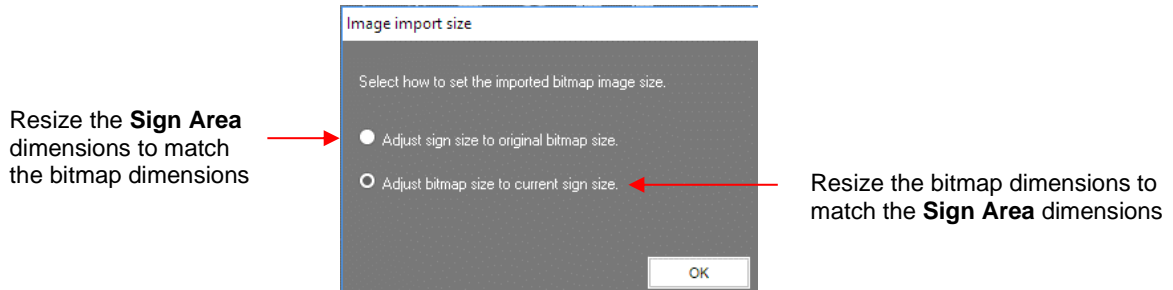

- ◇ Either choice is acceptable since both the bitmap and the **Sign Area** can later be changed. If the first option is selected, then the margin boundaries of the **Sign Area** will now touch the bitmap boundaries:

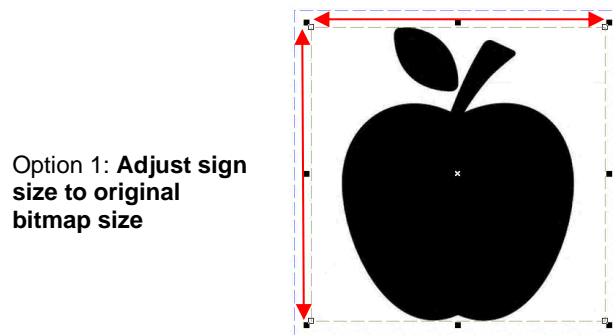

- ◇ If the second option is selected, the bitmap is sized to fit whichever dimension (X or Y) constrains the shape:

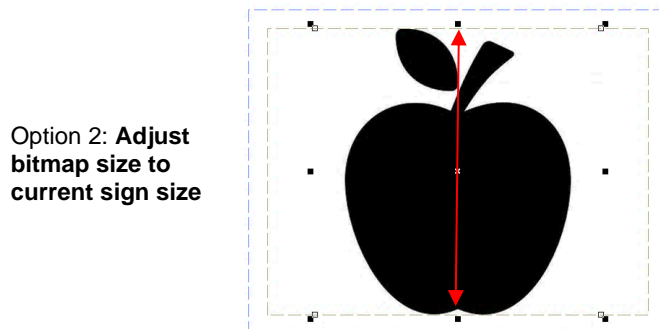

- ◇ Note that the image will not extend beyond the green-dashed margins inside the **Sign Area**.

5.01.2 Step-by-Step Tracing Process

- While SignCut Draw offers several methods for vectorizing imported images, the easiest one for creating a contour cut line is the **Create outline on bitmap** function.
- For this tutorial, an example of tracing an image for a contour cutting (print and cut) application is chosen:



- After importing the bitmap, click on the **Create outline on bitmap** icon  and the following additional settings appear:

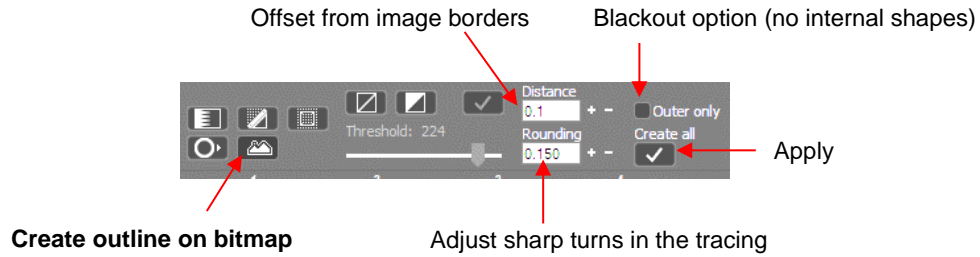

- The **Distance** setting is how far the trace line will be placed from the borders of the image:

- ◇ If you want the trace line to follow the print line, set **Distance** to 0:

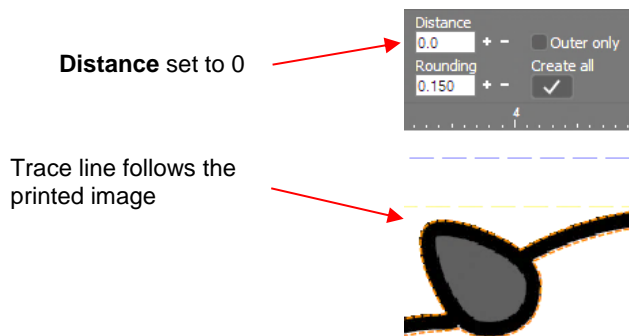

- ◇ If you want a contour cut around the printed image, such as used for stickers, set the **Distance** to a positive number:

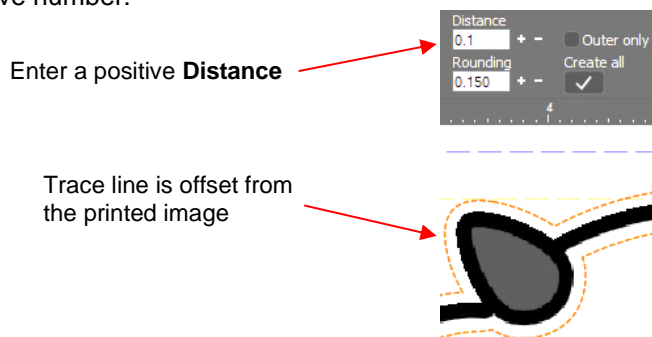

- ◇ If you want an inset cut line which is often used to allow for some error when cutting along the print line, set the **Distance** to a small negative number, such as -0.02 inch (-0.5 mm):

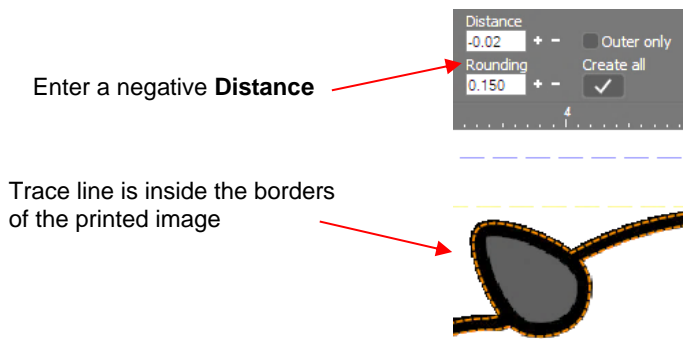

- ◇ To apply the settings, click on the **Create All** icon. The orange dashed lines will change color and will no longer be dashed, indicating the tracing is now set. To hide the original imported image, click on the **Hide Bitmap** icon. You will then see what lines will cut with these settings:

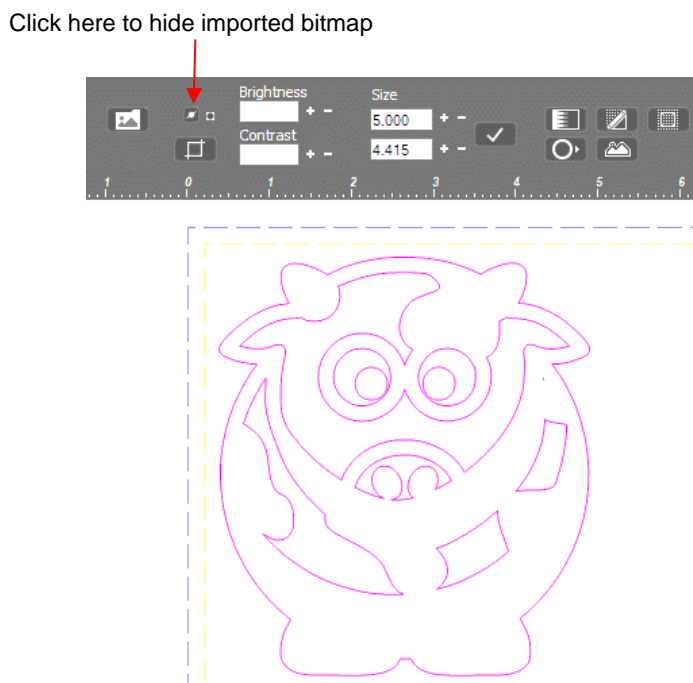

- ◇ For contour cutting, the internal cut lines are typically not needed. To omit them, first click the **Undo** button  at the top of the screen to back up a step. Next, click on the **Create outline bitmap** icon again, and mark the option for **Outer only**. Click on **Create all**. You will still see the internal trace lines, however, once you hide the original bitmap again, you'll observe the internal cuts are now removed:

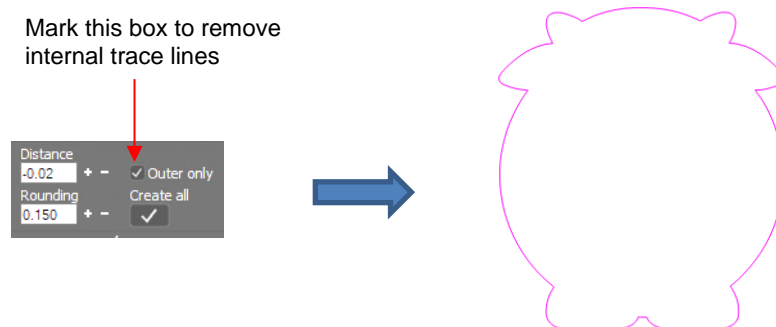

- If the trace lines are not fitting the original bitmap to your satisfaction, a **Threshold** setting can be adjusted. To do this, click on the **Black and white** icon and the **Tolerance** setting will light up and be adjustable:

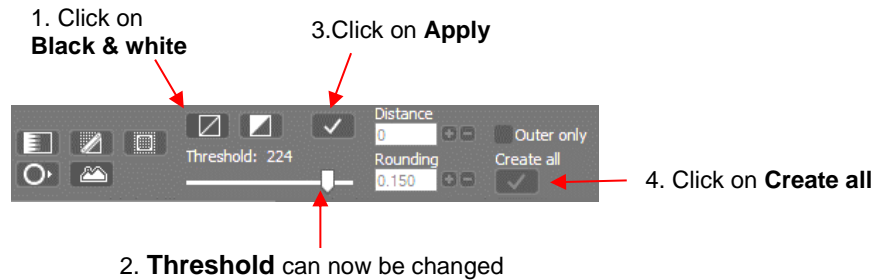

- ◇ If a tighter fit is needed, lower the **Threshold** setting and more nodes will be added. If a looser fit is needed, raise the **Threshold** setting and fewer nodes will be used.
- ◇ Note that clicking on the **Apply** icon above the **Threshold** setting will allow you to examine the trace before clicking on **Create all**. Thus, you can continue to make changes to **Threshold** until you are satisfied with the results.

- Additional vectorizing functions and settings are available in SignCut Draw. Refer to the SignCut user manual.

5.02 Editing a Trace

5.02.1 Node Editing a Contour Cut

- ◇ In the following example, it's discovered that there are a few gaps between the trace line and the bitmap that resulted in some white showing during a contour cut. Here's one example:



- ◇ With the trace line selected, click on the **Node Edit** icon  (or shortcut **O**) and the nodes making up the path of the cut will appear. Drag nodes, as needed, to move the path within the print area:

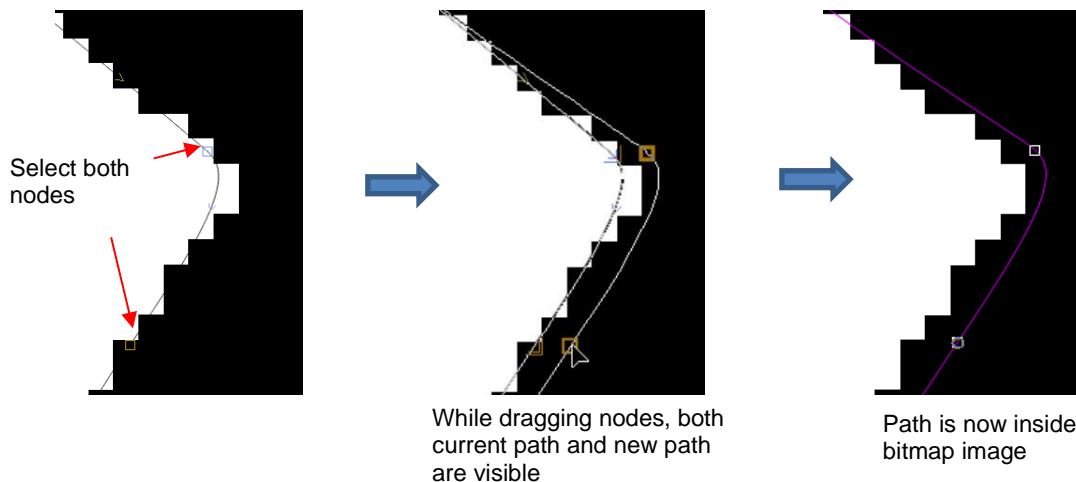

- Nodes can be individually moved or together at one time. In the prior screenshot, the Shift key was held so that two nodes were selected and then dragged together to move the path.

- Node editing in SignCut Draw offers many more features which are covered in the SignCut user manual.

5.02.2 Deleting Paths Within a Contour Cut Trace

- ◇ In the following example, a crab cartoon from *Doodle Dragon Studios* is traced:

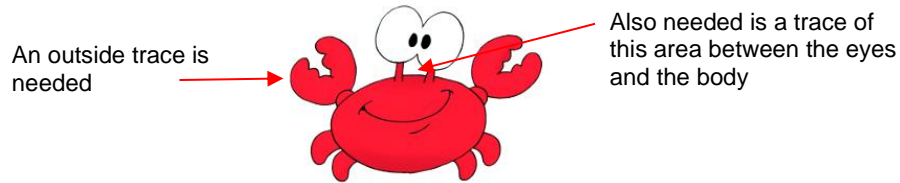

- ◇ The issue in this example is that the space below the eyes should be cut out but not other internal shapes, such as the pupils of the eyes. Note the difference in what will be cut between marking and not marking the **Keep Holes** option in the **Create Cut-Contour** window:

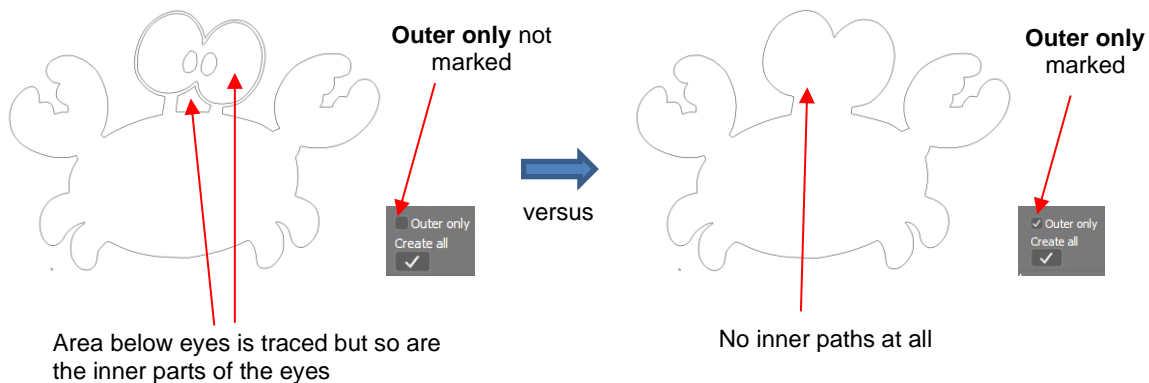

- ◇ The first option, **Outer only**, needs to be left unchecked so that the area beneath the eyes is traced. After creating the trace, click on the **Object edit** icon to return to the main screen. Click on the **View Bitmap** icon to hide the bitmap image:

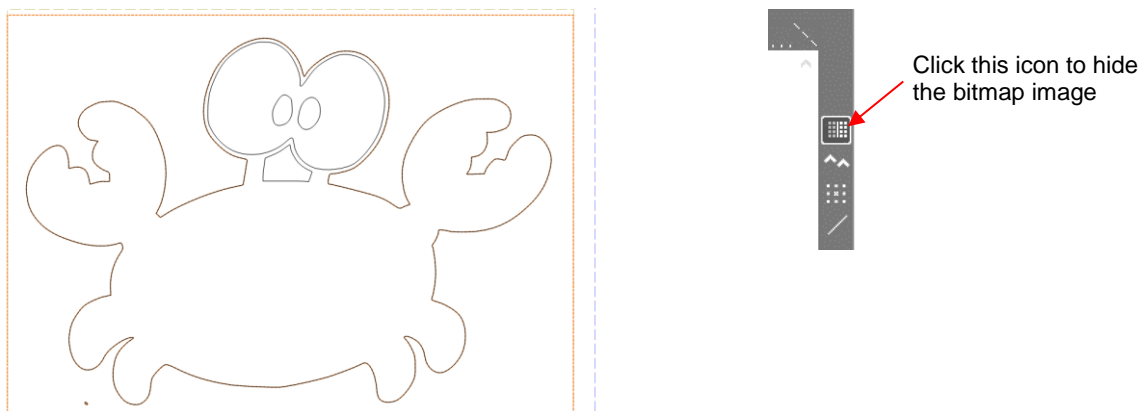

- ◇ Select the tracing and click on the **Ungroup** icon  on the **Properties & Functions Bar** (or press **Ctrl+U**). You can now individually select the shapes you want to remove and press the **Delete** key.

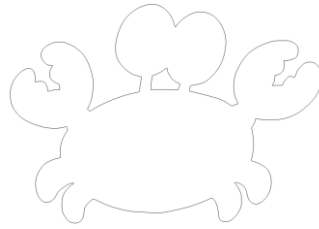

- ◇ You may wish to now reselect the outer and inner shapes and apply either a **Create group (Ctrl-G)** or **Combine objects (Ctrl-L)**:



5.03 Engraving Fills

SignCut Draw offers a number of different options to create engraving fills. The following sections cover each type.

5.03.1 Hatch Fill

- The **Hatch Fill** effect will create a linear fill that can be single-line or double-line (hatched):



- To add a linear fill, select the vector shape and click on the **Effects** icon  on the **Tools** panel (or press the shortcut key **A**). Mark the **Hatch** option and the **Properties & Function Bar** will now have the following settings and options:

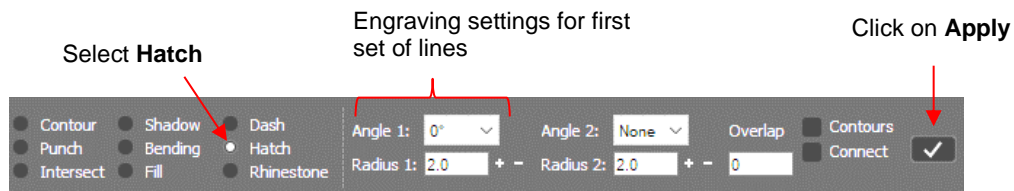

- Select the desired angle for the first line from the drop-down menu. Below, in the **Radius 1** field, enter the desired spacing between the lines. Normally, with a tool such as the Skycut engraver, a very small value would be used, such as 0.1 mm (or 0.004"). However, to better illustrate the effect for the screenshots used in this tutorial, a much larger value has been entered. Click on the **Apply** icon to accept the settings:



- As with other functions in *SignCut Draw*, if you want to make changes, use **Undo** to back up. Then change the settings, as desired. Perhaps you prefer a different angle:

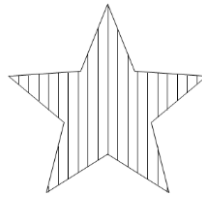
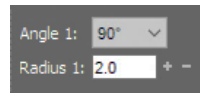

- To add a second set of lines for a hatch fill, select a different angle from the **Angle 2** drop-down menu and enter the desired spacing in the **Radius 2** field:

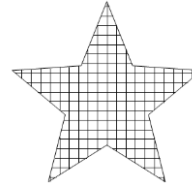

- The **Overlap** setting is typically used with rotary tools where the exact diameter of the tool is known. That is entered into the **Radius** field(s) and the **Overlap** is usually set to half that radius (or more) to make sure there are no gaps when the engraving occurs, assuming a complete fill is the goal:

Enter **Radius** of tool



Enter desired **Overlap**

- The **Contours** option will add both an inset and an outset contour line of the original shape with the spacing equal to the value set in **Radius 1**:

Mark **Contours**

Both inset and outset lines are added

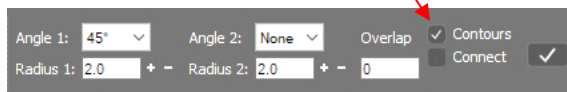

- Alternatively, if you mark the **Contours** option a second time, the option changes to **Inline** and the smaller internal shape is the result:

Mark again to change to **Inline**

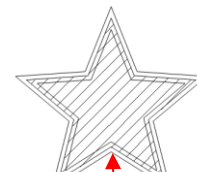
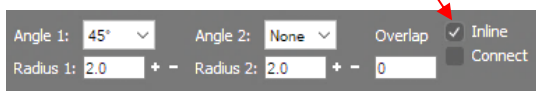

This is the **Inline** result

Versus the prior version with the original and outset lines

- The **Connect** option controls whether or not the tool stays down or rises at the end of each line. Thus, marking this option will result in lines connecting which can decrease the amount of time taken for the engraving to occur. With the outside border still present, it isn't apparent that the lines are connected. However, if you drag the original star outline away, you'll observe the difference:

Without **Connect** option marked:

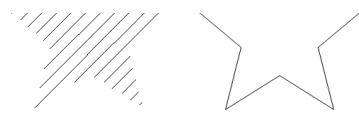

Individual lines

With **Connect** option marked:

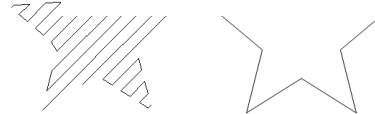

Lines are connected where possible

5.03.2 Contour Fill

- The **Contour Fill** (sometimes referred to as an island fill) is a progressive inset pattern based on the original shape; the tool drops to complete a path, raises, moves to the next path, drops to complete that path, etc. Some shapes work better than others with the **Contour Fill**:

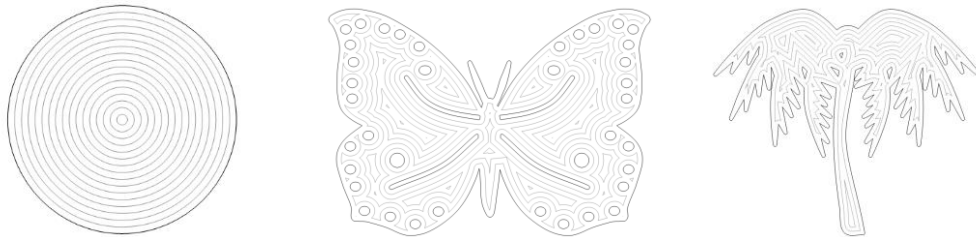

- To add a contour fill, select the vector shape and click on the **Effects** icon  on the **Tools** panel (or press the shortcut key **A**). Mark the **Contour** option and the **Properties & Functions Bar** will most likely look like this:

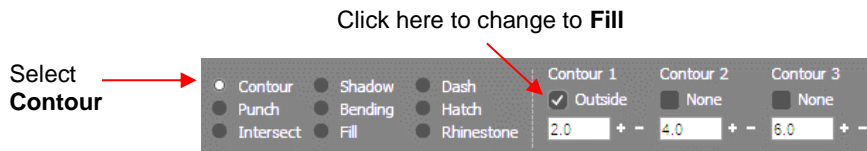

- Click several times on the check box next to **Outside**, under **Contour 1** until it changes to **Fill**:

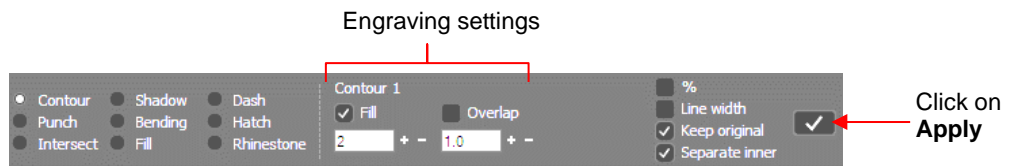

- Below **Fill**, enter the desired spacing between the lines. Normally, with a tool such as the Skycut engraver, a very small value would be used, such as 0.1 mm (or 0.004"). However, to better illustrate the effect for the screenshots used in this tutorial, a much larger value has been entered. Click on the **Apply** icon to accept the settings:



- With a smaller tool, the gaps seen in the prior screenshot will not necessarily be present. Thus, test out the actual settings you plan to use. Note that with a very small spacing, it can take a number of minutes for the pattern to be rendered.
- As with the **Hatch Fill** feature, an **Overlap** setting can be applied if the radius of a rotary tool is entered instead of the desired spacing:



5.03.3 Inside Fills Versus Outside Fills

- In certain situations, you might want to reverse the parts of a design that are filled. To do this, add any outside shape to the design, such as a rectangle, an oval, a heart, etc. Select both the inside and the outside shapes and apply **Combine objects (Ctrl-L)** .
- With the combined shapes selected, apply the **Hatch fill** function and the space between the original shape and the added outside shape fills with the lines:

◇ For example, if three stars have the **Hatch fill** applied, the result appears like this:



◇ However, if a rounded rectangle is added around these stars and **Combine objects** applied, then a **Hatch fill** results in this:



5.03.4 Line Raster from Bitmap

- The name of this trace option suggests a raster file is being created, however the result is actually a vector shape made up of a particular pattern of lines that are spaced in such a way that the result appears to be a raster image.



Original photo



Line raster from bitmap

- Note that flat colored clipart would not be suitable for this type of trace as the effect is dependent on variations of light and dark pixels.
- After importing a bitmap image, click on the **Create line raster from bitmap** icon  and the following window opens. However, note that the window will change settings depending on which **Application** option is selected in the top row.

Application options

Settings to be covered (will vary by **Application**)

Line raster

Cut lines Engrave lines Diffused lines

Horizontal Light: %

Vertical Contrast: %

Density (1-5):

Add bridges Add frame

Bridge count: Frame width:

Bridge width:

Settings to be covered (will vary by **Application**)

Click Create after selecting option and settings

◇ The three **Application** options create three different types of patterns, as shown here:

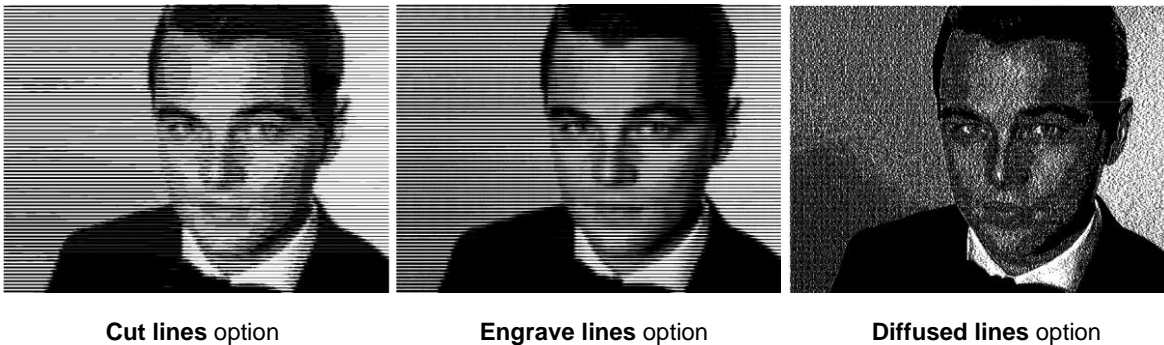

◇ When zoomed in at ~200%, and with **Show Fill** turned off, you can see the differences in the type of vector “cuts” that will be made.

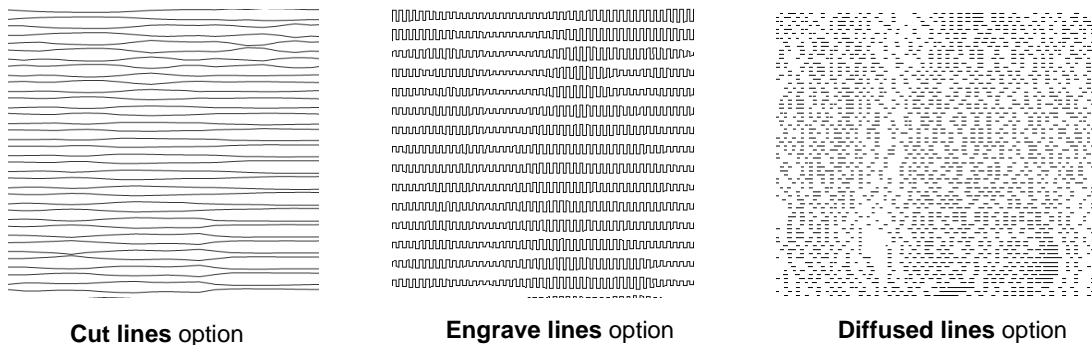

◇ After selecting the desired **Application** and entering appropriate settings, click on **Create**. Depending on the settings chosen and the size of the bitmap image, it can take quite some time to generate the line pattern. It’s often best to do something else while waiting: make a cup of coffee, respond to a few emails, pet your dog. 😊

- ◇ Once the line pattern is created and the window is closed, the image on the screen will still have the imported raster visible. Hide the raster, as needed, to view the results of the trace.
- The **Engrave lines** option is further described here as it is used in scratch engraving applications. It can also be used with other tools such as pens and markers. Note: The other **Line raster** options are covered in the SignCut user manual.
- With the **Engrave lines** option selected, the settings are as follows:

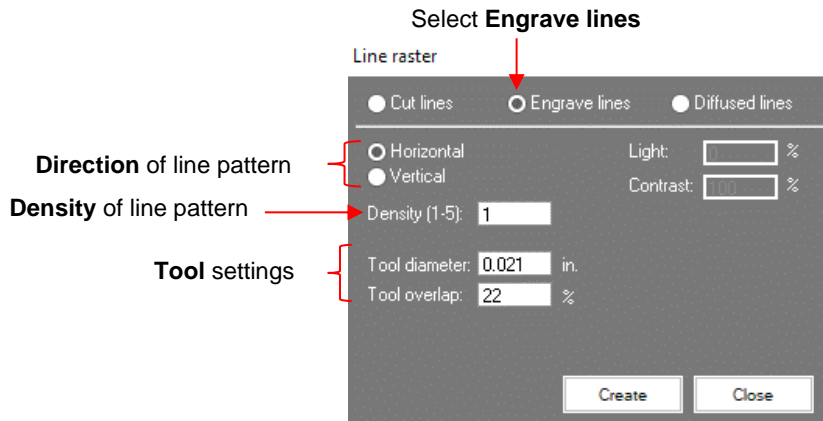

- ◇ **Direction of line pattern:** Select from either **Horizontal** or **Vertical**:



Horizontal



Vertical

- ◇ **Density** controls how many lines will be generated based on the size of the bitmap. If the number is set to the minimum of 1, then in a case like this example, there are so few that the pattern isn't recognizable. At the maximum of 5, the pattern is very clear but takes much longer to generate and will take much longer to engrave as well.

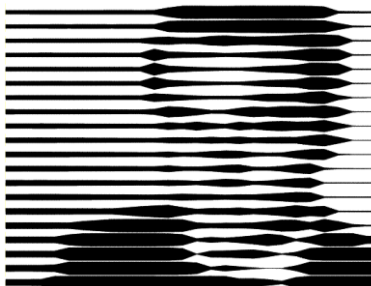

Density = 1

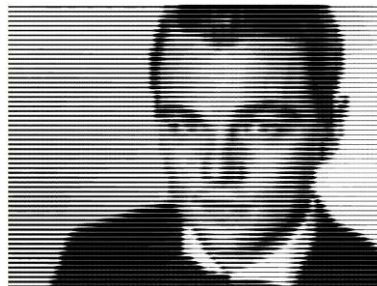

Density = 3



Density = 5

- ◇ **Tool Settings**

- **Tool diameter:** is the width of the line made by the tool tip as it's engraving, drawing, foiling, etc. If it's not specified on the particular tool in use, a test line can be made and then measured with a ruler or with a caliper. Very thin lines, such as those made with a scratch engraver, may not be

measurable, so testing with a few small patterns first (e.g. try a diameter 0.01” and test larger or smaller as needed) will help you determine what works best.

- The difference in the pattern between two **Tool diameters** is shown here:



Tool diameter = 0.02”



Tool diameter = 0.04”

- Zooming in on the nose, you can see how the pattern differs when the **Tool diameter** is larger:



Tool diameter = 0.02”



Tool diameter = 0.04”

- **Tool overlap:** this setting helps compensate when the measurement of the tool diameter isn't perfectly measured. It also helps compensate if small amounts of slippage occur on your machine. Essentially, the pattern lines are overlapped, by the percentage entered, while being executed so that no unintended gaps occur in the fill pattern.

Appendix A Troubleshooting FAQ's

A1 Communication Issues

I cannot get the Skycut to power on.

- Make sure the power cable is securely plugged into the adaptor.
 - Make sure the adaptor light is a steady blue light and it is plugged securely into the Skycut.
 - If you still cannot get the Skycut powered on, contact your dealer.
-

I cannot power off the Skycut.

- Press and hold the power button until the light shuts off.
-

I cannot get Wi-Fi to work with my Skycut.

- Set the Skycut close to the router when performing the initial setup presented in *Section 1.12.2*. After establishing communication, you can test how far the Skycut can be located from your router.
- In SignCut Pro's **Settings>Cutter** window, make sure you have selected **TCP**, entered the same **IP address** you selected during setup on the Skycut's control panel, and have **Port** set to 8080:

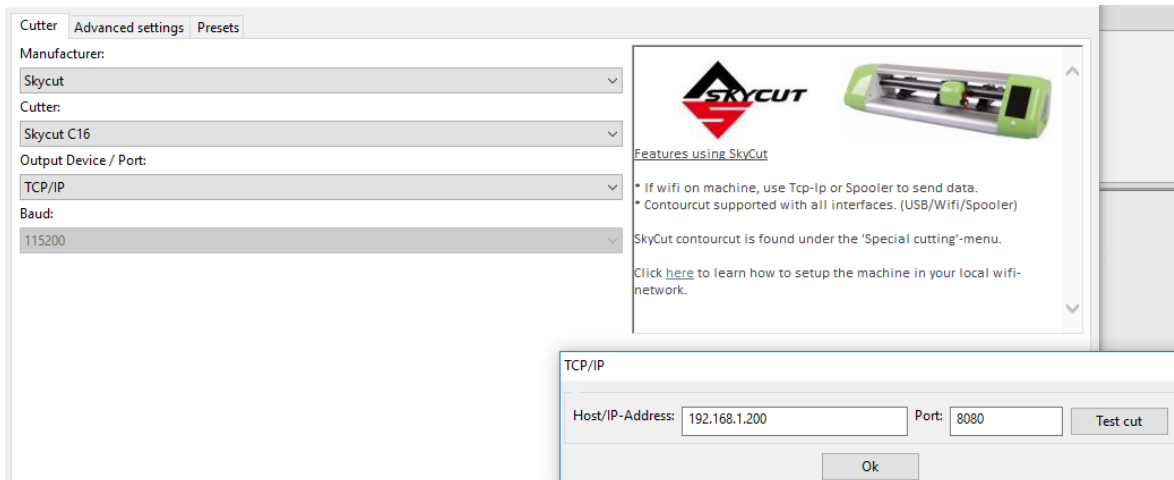

- Make sure your computer is connected to the same router as your Skycut.
 - Verify that **Flexi/SignCut** or **SignMaster/SCAL** is the selected software on the control panel under **Set>Sys Information**.
-

I cannot get USB to work with my Skycut.

- Unplug/replug the USB cable at both the computer and at the Skycut.
- In SignCut Pro's **Settings>Cutter** window, make sure **Output Device / Port** is set to **USB001**:

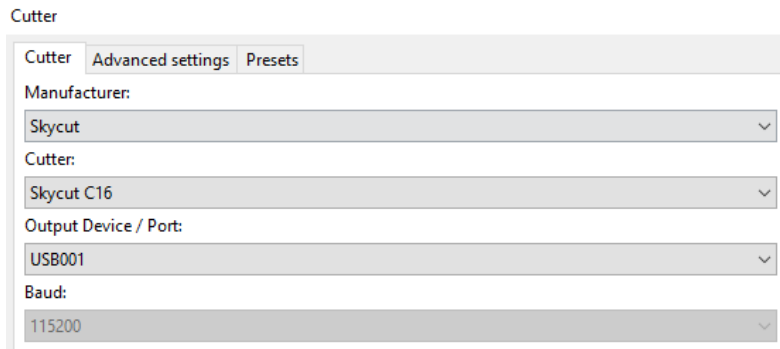

- Try a different USB port on your computer.
 - Verify that **Flexi/SignCut** or **SignMaster/SCAL** is the selected software on the control panel under **Set>Sys Information**.
 - Try a different USB cable.
-

*I had to cancel a cut. Now my Skycut is no longer responding when I click on **Cut out**.*

- Try restarting the Skycut and SignCut Pro.
-

A2 Operating Issues

The control panel isn't responding very well.

- Press control panel icons with your finger and not your fingernail. You can also use a black rubber stylus.
 - Make sure the control panel is clean.
-

My mat is rotating when the Skycut starts to cut!

- At least two pinch wheels need to be gripping the mat. Move the mat either left or right so that it is under two outer pinch wheels and the pinch wheels are aligned under white arrows. Refer to *Section 1.09*.
 - Make sure you are not trying to force the blade to cut too deeply and/or too quickly through a thick/dense material like chipboard or craft plastic. Slow the speed, decrease the **Force**, and add more passes.
-

My vinyl isn't feeding evenly while cutting. It starts bunching up on the inside of the end cap.

- Even if you feel the vinyl is aligned properly at the start of the cut, a slight "out of alignment" error will become more pronounced with a long cut. When you first drop the pinch wheels, use the arrow keys to feed the vinyl for the length of the cut to make sure it is feeding straight. If not, then about half-way along the length of the vinyl needed, lift the pinch wheels and realign the vinyl. Continue testing the alignment until you can verify that the vinyl is sufficiently aligned for the entirety of your project.
-

The pinch rollers are not tight enough to hold the vinyl I'm cutting. The vinyl is slipping and rotating when I start the cut.

- The pinch wheels need to be over grit shafts (the dark gray rough areas along the revolving shaft. The white arrows will help you align the pinch wheels in correct locations. Also, use outside locations versus having, say, one pinch on the far right of the vinyl and a second pinch wheel only in the middle.
-

I hear a terrible stuttering sound when trying to cut chipboard (or other thick dense material).

- That can be a symptom of forcing the blade to cut too deeply and/or too quickly through the chipboard. Slow the speed, decrease the **Cutting force**, and add more passes.
-

I'm trying to do a PNC application and the camera can't read the marks.

- Make sure you have calibrated the Skycut's camera. The procedure is covered in *Section 3.03*.
 - On the control panel, go to **Set>Camera** and press **Set**. Make sure the **Auto PNC** option is marked.
 - If using the cutting mat, make sure the printout is aligned fairly straight on the cutting mat and the mat is fairly straight in the cutter.
 - Make sure the blade holder is over the lower right registration mark when starting the cut.
 - Are the registration marks printed dark with no streaking or missing ink?
 - Did you make any changes in the file after printing and before trying to cut?
-

The Skycut stopped during a cut.

- If the Skycut stops with the head over on the left side of the cutter, you have most likely exceeded the cutting range. Several things to consider:
 - ◇ Check the width of your project. It cannot exceed 16".
 - ◇ Check how far you are moving the head to the left when setting the origin. If your project is 15" and you moved the head more than 1" to the left, you will send the cut out of range and the cutter will stop.
 - If the Skycut stops and the head is not located near the left side:
 - ◇ Make sure it's not a communication issue.
 - ◇ You may have exceeded a buffer limit. Try reducing the number of nodes. In *SignCut Draw*, select the shapes and click on the **Reduce number of nodes** icon .
-

I'm doing a dual head application but all layers are being executed by the left side.

- On the control panel's **Home** screen, make sure **Use Double Head** is selected.
- In SignCut Pro2, in the **Cut out** window, on the **Cutting** tab, select **D24** from the **Choose cutter preset** menu.

- In SignCut Pro, select each color(s) that should be executed on the right side and click on **Edit Attributes**. Make sure **Tool 2** is selected.
-

A3 Cutting/Drawing Issues

My shapes are drawing (cutting) off the material. What am I doing wrong?

- When setting the origin, make sure you are using the tip of the blade as the reference point and set the tip inside the corner of the material (not too close to an outside edge).
 - Verify that the preview window in *SignCut Pro* matches where you expect the shapes to cut.
-

When drawing with the test pen (or cutting with the blade holder), I have extra lines being drawn (or cut).

- Make sure you raise the pen (or blade holder) in the blade holder seat on the Skycut before tightening the screw. The blade holder seat needs to be able to drop the tool down when it reaches the spot to start the shape. Otherwise, the tool tip will be dragging across the material from the origin to where the shape will begin and then back to the origin at the end of the “cut”.
-

I'm drawing with a pen and there are bubbles at the corners.

- For perfect corners when using a pen, make sure that **Blade Offset** and **Overcut** are both set to 0 in the **Cut out** settings. You do not need an offset for pens (or other tools like embossers and engravers).



My cut started out fine but by the end of the cut, it's not cutting through the material.

- Make sure the blade holder housing doesn't have any bits of material inside of it.
 - Make sure the screw on the blade holder seat is tight so that the blade holder isn't slipping upwards during the cut.
 - Make sure the cutting mat is clean and sticky and the material is pressed down completely, so that the material remains stabilized during the cut.
 - Make sure the blade isn't cutting too deep into the mat. This can sometimes cause the material to be pulled up and away from the mat as the blade releases from the plastic it is cutting.
 - Try increasing the cutting force by ~ 5 – 10.
-

My cut is clean in some places but not in others. Why am I not getting consistent cutting?

- Try raising the blade holder in the blade holder seat. If the blade is too close to the material, not enough force is being applied. Refer to *Section 2.01.3, Set the Blade Height Above the Material*.
 - Make sure your material is pressed firmly onto a clean and sticky mat (assuming you are cutting a material such as paper or cardstock).
 - Your material may require two passes if it's not homogenous or if it is heavily textured. Sometimes intricate shapes also cut better with two passes.
 - Also, if the material has been exposed to humidity, then it will become difficult to cut in one pass. You can dry both paper and cardstock using a blow dryer or in a very low-temperature oven.
 - If you are cutting vinyl without a cutting mat, check the cutting strip to make sure it is still in good condition.
-

I have the outside edges of my chipboard completely taped but I'm not getting clean cuts, even after lots of passes.

- Taping the edges prevents shifting of the chipboard but it's not enough for stabilizing. You need to thoroughly press the entire surface of the chipboard onto a clean and sticky mat. Using a brayer is recommended.
-

I am getting a lot of tearing in my cuts.

- A number of things can cause tearing so work through this check list:
 - ◇ Too much blade is exposed. If you see cut lines in your mat or the backing sheet, shorten the blade exposure. You should only be cutting through the material itself.
 - ◇ The blade is chipped. Try a different blade.
 - ◇ The paper is not adhered well to the mat. Make sure the mat is clean, sticky, and the paper is pressed smoothly and evenly on the surface.
 - ◇ You may be using too much cutting force. Try reducing it and doing test cuts.
 - ◇ You may have too many nodes in the shape. In *SignCut Draw*, select the shapes and click on the **Reduce number of nodes** icon .
 - ◇ The material itself may be subject to tearing, especially on intricate cuts. Also, if the cardstock has been exposed to humidity, then the moisture in the material can make it difficult to cut cleanly. You can dry paper and cardstock using a blow dryer or in a very low-temperature oven.
-

I'm cutting very small lettering and the letters are a bit distorted.

- Verify that you are using the correct **Blade Offset**.
 - Try slowing down the cut. Small lettering needs slower speed.
-

My cut shapes are not the same dimensions as what they are set to in SignCut Pro.

- Perform the calibration procedure shown in *Section 2.08*.
-

My shapes are not completely cutting out. They are still attached to the waste part of the material.

- Make sure you have set an appropriate **Overcut** setting.
- Make sure the mat is not skewing during the cut. This can happen if even one of the pinch wheels is no longer centered under a white arrow. It can also happen if the speed and/or pressure is set too high.

My cardstock is not cutting all the way through. I have the blade all the way out and using the maximum force.

- Please refer to *Section 1.07.3*. It's important to only have as much blade exposed as is necessary to penetrate the cardstock. You may also need to raise the blade tip height (*Section 2.01.3*). Reduce your force back to suggested values for the material you are cutting and do a test cut.