

# OPERATOR'S MANUAL

## Mug Cuter GS-201

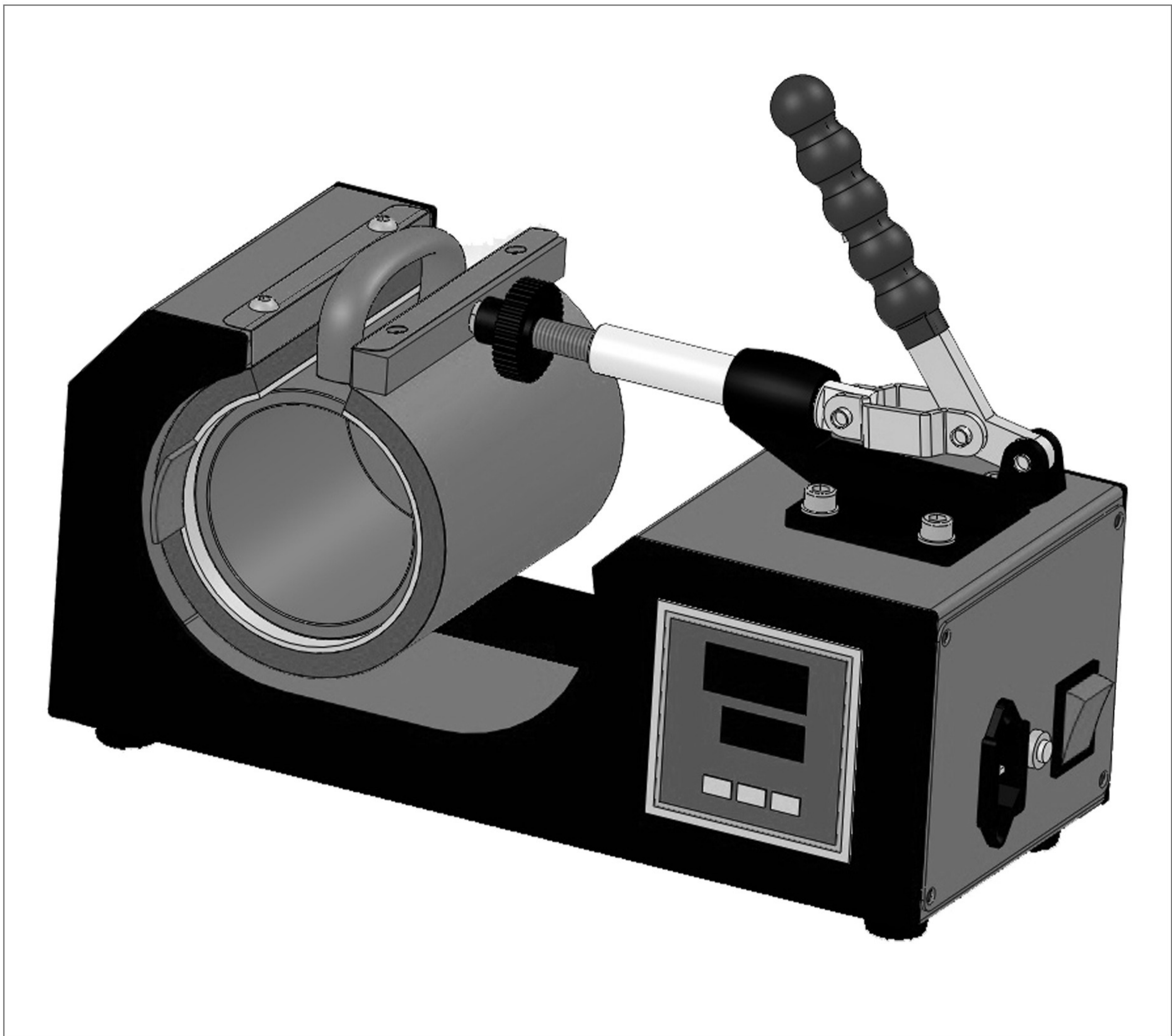

### CONTENTS

Important Safety instructions.....	01
Technical Parameters.....	02
Operation Process.....	03
Terms Of Guarantee.....	04
Circuit Diagram.....	05
Explosion View.....	06

# Important Safety Instructions

## Important Safety Instructions

WHEN USING YOUR APPLIANCE, BASIC PRE-CAUTIONS SHOULD ALWAYS BE FOLLOWED, INCLUDING THE FOLLOWING:

Read all instructions.

Use appliance only for its intended use.

To reduce the risk of electric shock, do not immerse the appliance in water or other liquids.

Never pull cord to disconnect from outlet, instead grasp plug and pull to disconnect.

Do not allow cord to touch hot surfaces, let appliance cool completely before putting away.

Do not operate appliance with a damaged cord, or if the appliance has been dropped or damaged. To reduce the risk of electric shock, do not disassemble or attempt to repair the appliance, take it to a qualified service person for examination and repair. Incorrect reassembly or repair could cause a risk of fire, electric shock, or injury to persons when the appliance is used.

Close supervision is necessary for any appliance being used by or near children.

Do not leave appliance unattended while connected.

Burns could occur from touching hot metal parts.

To reduce the likelihood of circuit overload, do not operate another high voltage appliance on the same circuit.

If an extension cord is absolutely necessary, a 20 ampere rated cord should be used. Cords rated for less amperage may overheat, care should be taken to arrange the cord so that the cord cannot be pulled or tripped over.

**SAVE THESE INSTRUCTIONS.**

# Technical Parameters

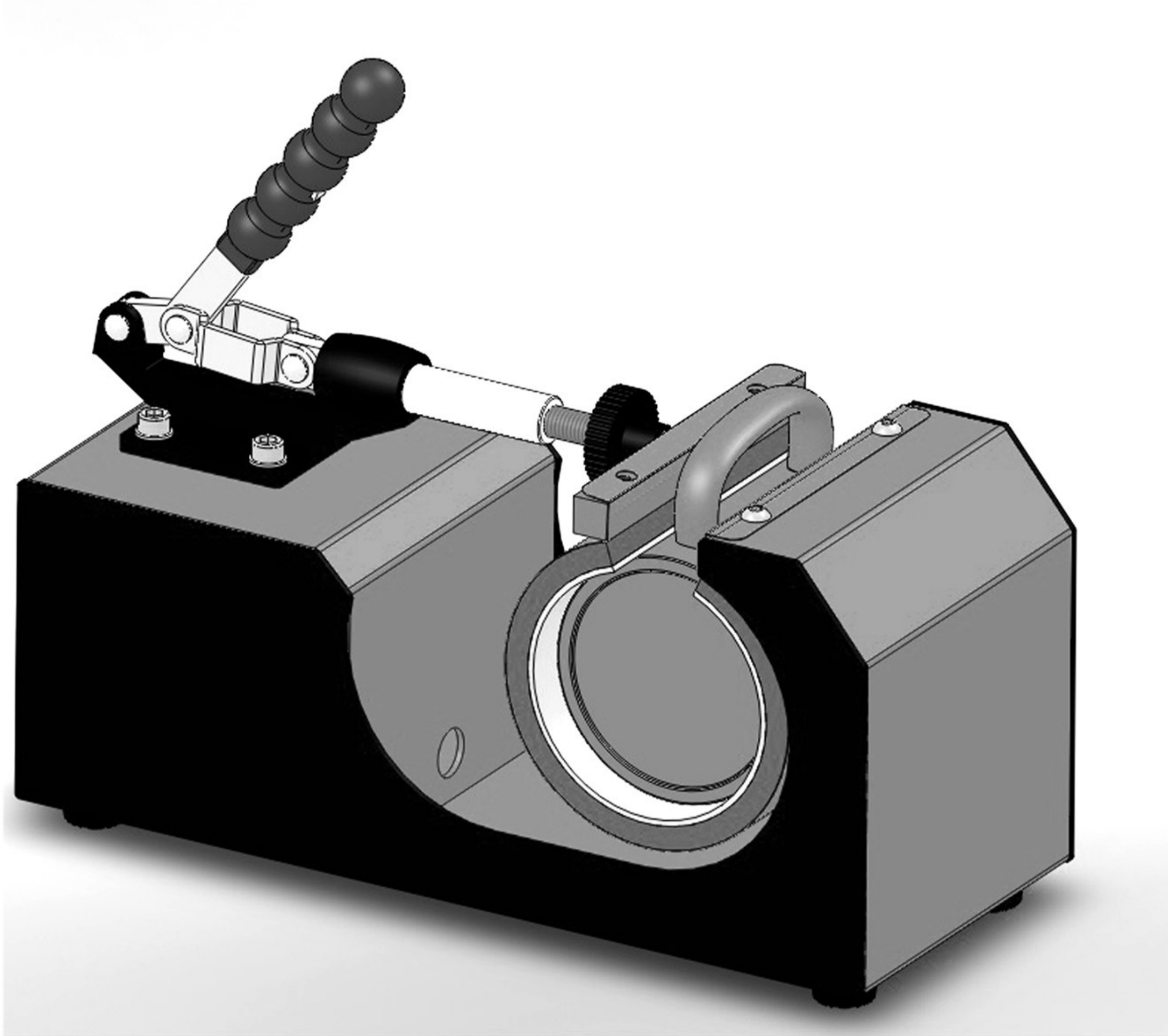



## Technical Parameters



1. Model No.: Mug Cuter GS-201
2. Machine Dimension: 310\*130\*150mm
3. Mug Heater Size: Dia.6-7.5cm for 6oz,9oz,10oz etc Mug(chooseable)  
Dia.7.5-9.0cm for 11oz,15oz etc Mug (with machine)
4. Printable Articles Max Size:  $\phi$ 100\*120mm
5. Voltage: 220V/1Phase; 110V/1Phase
6. Power: 300W
7. Time Range: 0~999s
8. Maximum Temp: 400 C°
9. Packing Size: 39.5\*23\*30cm
10. Gross Weight: 5.2kg

# Operation Process

## 1. Temperature/Time Setting

		
<p>Turn on power switch, control board shows as picture.</p>	<p>Press <b>SET</b> button first time, the PV part shows "sp". Press arrows "△" or "▽" to set temperature.</p>	<p>Press <b>SET</b> button second time, the PV part shows "st". Press arrows "△" or "▽" to set time.</p>

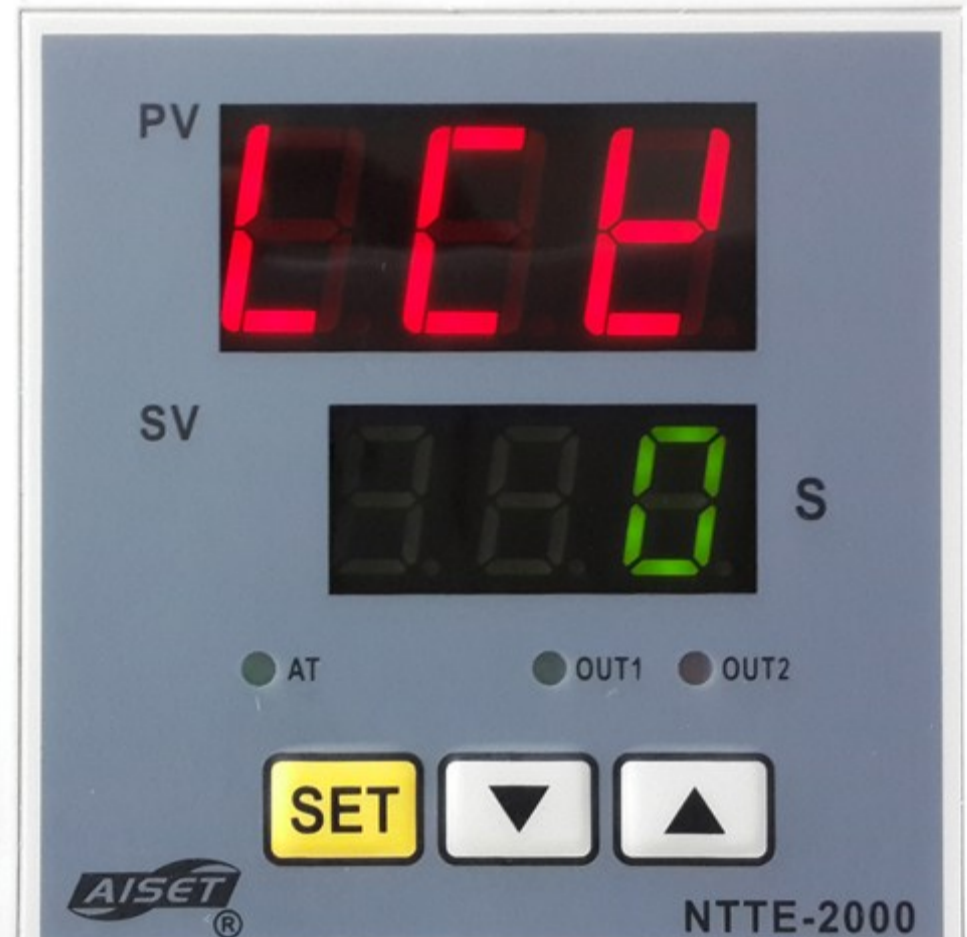
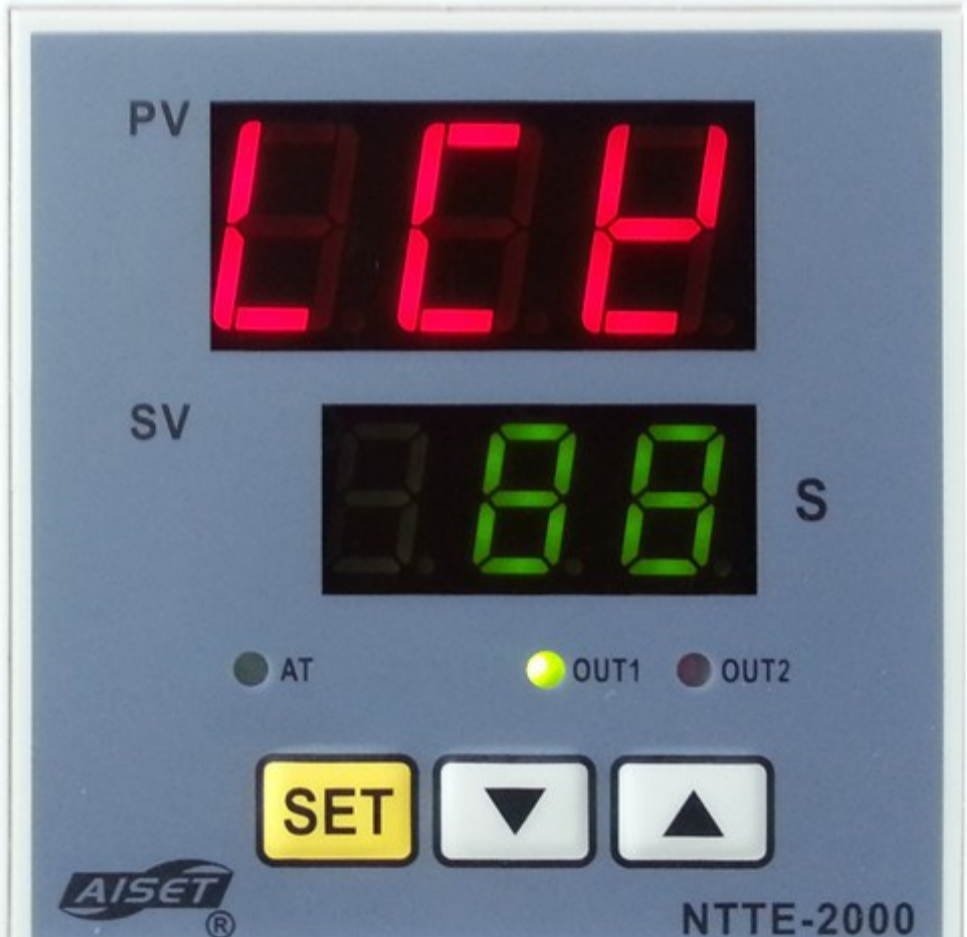
## 2. Celsius(°C)/ Fahrenheit (°F) Setting

		
<p>Press "△" and "▽" once time, control board shows as picture.</p>	<p>Press "△" to input 88 as picture</p>	<p>Press <b>SET</b> button to enter into next interface, then press <b>SET</b> to choose the "ctr" interface as picture, press "△" and "▽" to change "SV" no as 0(for Celsius) or 1(for Fahrenheit). press <b>SET</b> 4 seconds to quit.</p>

## 3. Temperature Compensation Setting

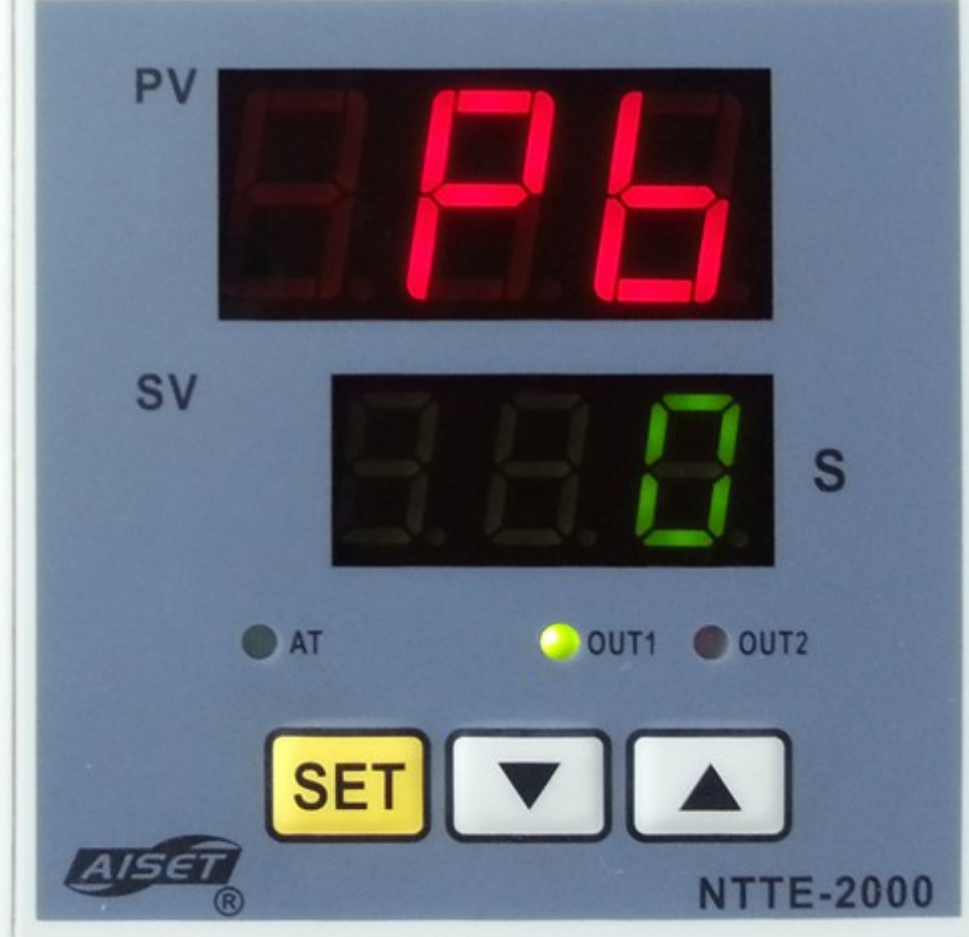
	
<p>press <b>SET</b> button 4 seconds to enter into interface as picture.</p>	<p>press <b>SET</b> to choose "pb" interface as picture, then Press "△" and "▽" to set temperature compensation numbers. For example, if the real temperature is 15 °C higher than control board shows, pls input +15 into the AV part, if the real temperature is 15°C lower than control board shows, pls input -15 into the AV part. press <b>SET</b> 4 seconds to quit.</p>

**Remark:** Press "△" 20 seconds to reset to defaults.

# Terms of Guarantee

## Warranty

Lopo will Automatically register the equipment on the date it was shipped to you, please fill the following information and keep this manual in a safe place if you are buying the machine for your own use or please remind your customers to do this if you are our distributor.

Date Purchased:

From:

Model No#:

Serial#:

Model No. and the Serial No. could be found at the outside of the packing. Please provide this information to us when there is any problem of the machine , thanks

## Note:

This Warranty applies to equipment manufactured by LOPO.

## Duration

The Warranty period of one year are started from the date of receipt by the buyer of the heat press machine ,which can be verified by the invoice and the copy of the above information. The warranty does not cover any damager casued by normal were or tear

## Repair

If any parts are found to be defective, despite proper use, authorized use and not as a result of fair wear and tear, within the warranty period, then they will be replaced without any question within 3 working days after our confirmation. Lopo have the rights to ask customers to offer as much details of the problem in order to find out the solution , customer need to help us to offer the details on time. All the cost including the shipping cost would be borne by Lopo at the first 3 months , after 3month, the shipping cost need to be borne by the customer, but the free parts will be offered during the entire Guarantee period. Customer need to pay for the parts after one year Guarantee , but Lopo will offer the whole life technical support.

This Warranty does not cover silicon pads, Teflon sheet, or any consumables for the heat press machine

## Circuit Breaker

If the circuit breaker should become dislodaged ,it can easily be reinstated after the heat press machine had cooled down.It is recommended to try and eliminate the source of any failure by using the error checklist

## Set Up

It is important that the heat press machine is fixed securely to your workshop. To set up the press, it is necessary to fully open the press, and place the substrate that is to be printed flat on the lower platen. If the press is not fully open , there is a risk of being burnt. Always follow the supplied instructions for printing for all the blanks you may print.

# Circuit Diagram

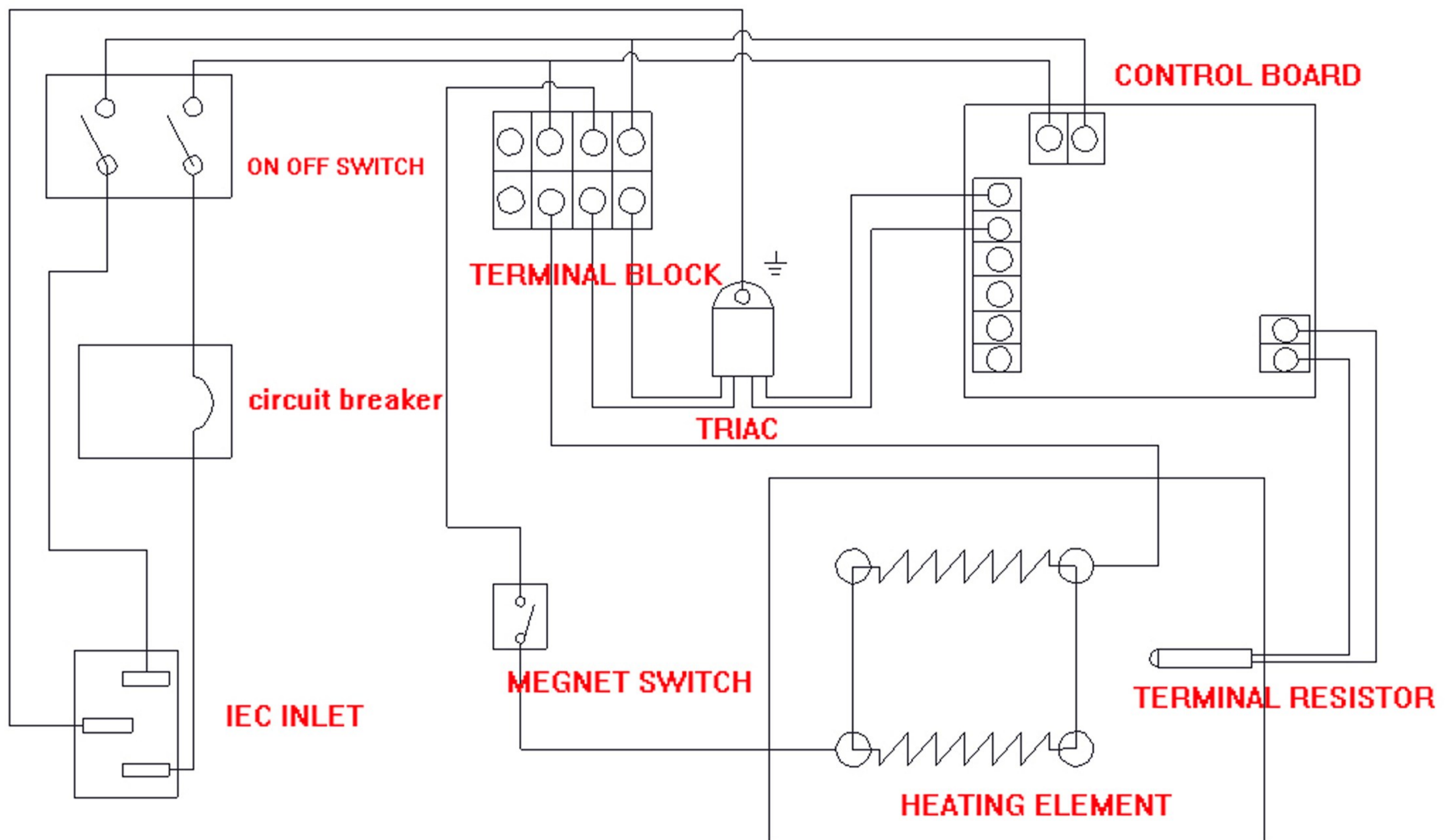

# Explosion View

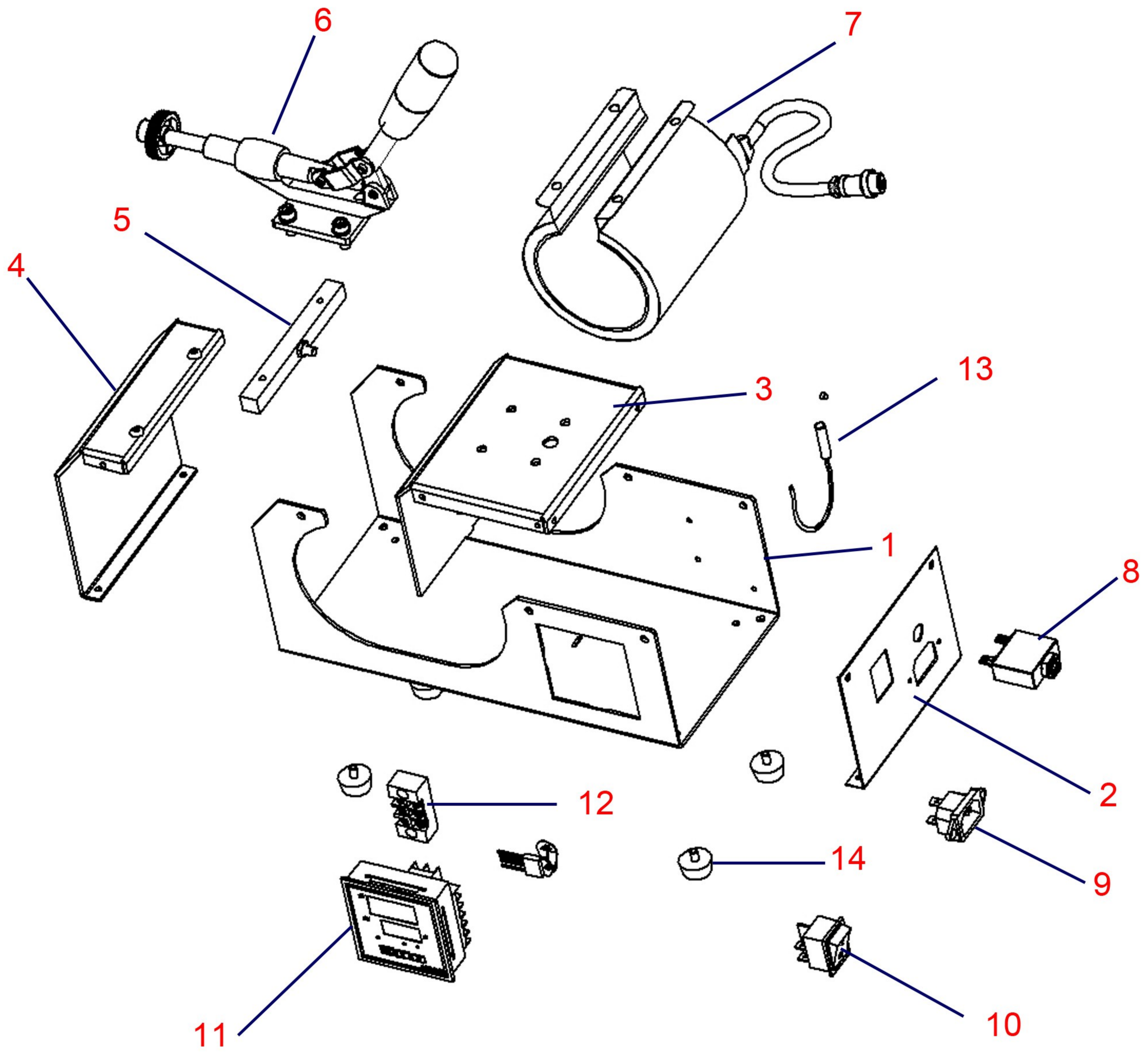

Serial No.	Part Name	Qty
1	Machine Base	1
2	Back Sheet	1
3	Toggle Clamp Base	1
4	Front Sheet	1
5	Heater Fix Bar	1
6	Toggle Clamp	1
7	Mug Heater	1

8	Fuse	1
9	Plug Base	1
10	Swich	1
11	Control Board	1
12	Line Bank	1
13	Limit Swich	1
14	Rubber Foot	4

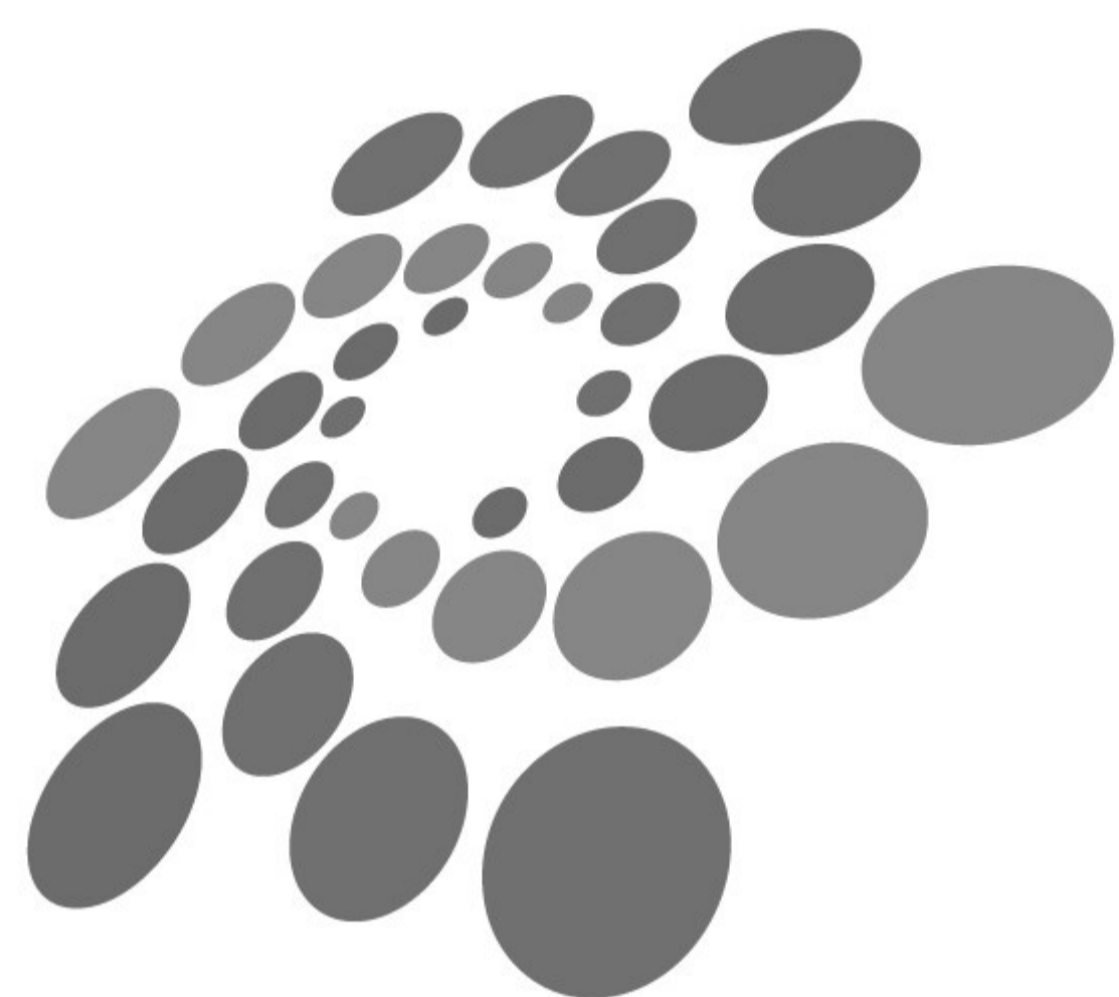

**GALAXY**  
P R E S S